



DST WRC-CA

English

Contents

1	Information about the documentation	2
1.1	About this documentation	2
1.2	Explanation of symbols used	2
1.2.1	Warnings	2
1.2.2	Symbols in the documentation	3
1.2.3	Symbols in the illustrations	3
1.3	Text markings	3
1.3.1	Software	3
1.4	Stickers/plates	3
1.5	Product information	3
1.6	Declaration of conformity	4
2	Safety	4
2.1	General power tool safety warnings	4
2.2	Additional safety instructions, remote control unit	5
2.3	Battery use and care	6
3	Description	6
3.1	Product overview	6
3.2	Information content of display and status bar	7
3.3	Intended use	7
3.4	Cut Assist	7
3.5	Joystick	7
3.6	Control knob	8
3.7	EMERGENCY STOP	8
3.8	Buttons/keys on the remote control unit	8
3.9	Function buttons	8
3.10	Parameter settings <...>	8
3.11	Functions <<...>>	8
3.12	Items supplied	9
4	Technical data	9
4.1	Remote control unit	9
4.2	Wireless communication (between the DST WRC-CA remote control unit and wall/diamond saw)	10
4.3	PUA 81 charger	10
4.4	PRA 84 Li-ion battery	10
4.5	PRA 84 G Li-ion battery	10
4.6	Interfaces	10
5	Preparations at the workplace	11
5.1	Removing the battery	11
5.2	Charging the battery	11
5.3	Inserting the battery	11
5.4	Pairing the remote control unit and partner device	11
5.5	Setting the language, country and unit of measure	11
5.6	Setting the line fuse rating	11
5.7	Setting the cutting parameters	12
5.8	Saw blade diameter and blade guard	12
5.8.1	Setting the diameter of the saw blade and the blade guard	12
5.8.2	Changing the diameter of the saw blade or blade guard	12
5.8.3	Removing the saw blade diameter with blade guard from the list	12

5.9	Activating cooling water control	12
5.10	Changing the password	13
5.11	Setting screen brightness	13
5.12	Setting the date and time	13
5.13	Reading messages	13
5.14	Reading the logbook	13
5.15	Technical information and next service	14
5.16	Resetting the settings	14
6	Manual operation	14
6.1	Overview	14
6.2	Cutting with the wall saw in manual mode	14
7	Assisted operation with Cut Assist	15
7.1	Overview	15
7.2	Cutting with the wall saw in Cut Assist mode	15
7.3	Interrupting an assisted cut	16
7.3.1	Pausing the cut and resuming in manual mode	16
7.3.2	Interrupting a cut	16
7.4	Changing the saw blade	16
7.5	Configuring the blade guard	17
8	Care and maintenance of cordless tools	17
9	Transport and storage of cordless tools	18
10	Troubleshooting	18
11	Disposal	18
12	Manufacturer's warranty	19
13	FCC statement (applicable in US) / IC statement (applicable in Canada)	19

1 Information about the documentation

1.1 About this documentation

- Read this documentation before initial operation or use. This is a prerequisite for safe, trouble-free handling and use of the product.
- Observe the safety instructions and warnings in this documentation and on the product.
- Always keep the operating instructions with the product and make sure that the operating instructions are with the product when it is given to other persons.

1.2 Explanation of symbols used

1.2.1 Warnings

Warnings alert persons to hazards that occur when handling or using the product. The following signal words are used:

 **DANGER**

DANGER !

- ▶ Draws attention to imminent danger that will lead to serious personal injury or fatality.
-

 **WARNING**

WARNING !

- ▶ Draws attention to a potential threat of danger that can lead to serious injury or fatality.
-



⚠ CAUTION

CAUTION !

- ▶ Draws attention to a potentially dangerous situation that could lead to slight personal injury or damage to the equipment or other property.

1.2.2 Symbols in the documentation

The following symbols are used in this document:

	Read the operating instructions before use.
	Instructions for use and other useful information
	Dealing with recyclable materials
	Do not dispose of electric equipment and batteries as household waste

1.2.3 Symbols in the illustrations

The following symbols are used in illustrations:

	These numbers refer to the corresponding illustrations found at the beginning of these operating instructions
	The numbering reflects the sequence of operations shown in the illustrations and may deviate from the steps described in the text
	Item reference numbers are used in the overview illustrations and refer to the numbers used in the product overview section
	This symbol is intended to draw special attention to certain points when handling the product.
	Wireless data transfer

1.3 Text markings

1.3.1 Software

The following text markings are used in this documentation:

HOME	Buttons/keys are in bold uppercase letters
<...>	Settings are inside single chevrons
<<...>>	Functions are inside double chevrons
Meldungen	Screen titles have a grey background

1.4 Stickers/plates

On the product

	Product features the Cut Assist function
--	--

1.5 Product information

Hilti products are designed for professional use and may be operated, serviced and maintained only by trained, authorized personnel. This personnel must be informed of any particular hazards that may be encountered. The product and its ancillary equipment can present hazards if used incorrectly by untrained personnel or if used not in accordance with the intended use.

The type designation and serial number are stated on the rating plate.

- ▶ Write down the serial number in the table below. You will be required to state the product details when contacting Hilti Service or your local Hilti organization to inquire about the product.

Product information

Remote control unit	DST WRC-CA
Generation	01
Serial no.	

1.6 Declaration of conformity

We declare, on our sole responsibility, that the product described here complies with the applicable directives and standards. A copy of the declaration issued by the certification department can be found at the end of this documentation.

The technical documentation is filed and stored here:

Hilti Entwicklungsgesellschaft mbH | Tool Certification | Hiltistrasse 6 | 86916 Kaufering, Germany

2 Safety

2.1 General power tool safety warnings

WARNING

Read all safety warnings and all instructions. Failure to follow the warnings and instructions may result in electric shock, fire and/or serious injury.

Save all warnings and instructions for future reference.

Work area safety

- ▶ **Keep work area clean and well lit.** Cluttered or dark areas invite accidents.
- ▶ **Do not operate power tools in explosive atmospheres, such as in the presence of flammable liquids, gases or dust.** Power tools create sparks which may ignite the dust or fumes.
- ▶ **Keep children and bystanders away while operating a power tool.** Distractions can cause you to lose control.

Electrical safety

- ▶ **Avoid body contact with earthed or grounded surfaces, such as pipes, radiators, ranges and refrigerators.** There is an increased risk of electric shock if your body is earthed or grounded.
- ▶ **Do not expose power tools to rain or wet conditions.** Water entering a power tool will increase the risk of electric shock.

Personal safety

- ▶ **Stay alert, watch what you are doing and use common sense when operating a power tool. Do not use a power tool while you are tired or under the influence of drugs, alcohol or medication.** A moment of inattention while operating power tools may result in serious personal injury.
- ▶ **Use personal protective equipment. Always wear eye protection.** Protective equipment such as dust mask, non-skid safety shoes, hard hat, or hearing protection used for appropriate conditions will reduce personal injuries.
- ▶ **Prevent unintentional starting. Ensure the switch is in the off-position before connecting to battery pack, picking up or carrying the tool.** Carrying power tools with your finger on the switch or energising power tools that have the switch on invites accidents.
- ▶ **Remove any adjusting key or wrench before turning the power tool on.** A wrench or a key left attached to a rotating part of the power tool may result in personal injury.
- ▶ **Do not overreach. Keep proper footing and balance at all times.** This enables better control of the power tool in unexpected situations.
- ▶ **Dress properly. Do not wear loose clothing or jewellery. Keep your hair, clothing and gloves away from moving parts.** Loose clothes, jewellery or long hair can be caught in moving parts.
- ▶ **If devices are provided for the connection of dust extraction and collection facilities, ensure these are connected and properly used.** Use of dust collection can reduce dust-related hazards.

Power tool use and care

- ▶ **Do not force the power tool. Use the correct power tool for your application.** The correct power tool will do the job better and safer at the rate for which it was designed.
- ▶ **Do not use the power tool if the switch does not turn it on and off.** Any power tool that cannot be controlled with the switch is dangerous and must be repaired.



- ▶ **Disconnect the battery pack from the power tool before making any adjustments, changing accessories, or storing power tools.** Such preventive safety measures reduce the risk of starting the power tool accidentally.
- ▶ **Store idle power tools out of the reach of children and do not allow persons unfamiliar with the power tool or these instructions to operate the power tool.** Power tools are dangerous in the hands of untrained users.
- ▶ **Maintain power tools. Check for misalignment or binding of moving parts, breakage of parts and any other condition that may affect the power tool's operation. If damaged, have the power tool repaired before use.** Many accidents are caused by poorly maintained power tools.
- ▶ **Keep cutting tools sharp and clean.** Properly maintained cutting tools with sharp cutting edges are less likely to bind and are easier to control.
- ▶ **Use the power tool, accessories and tool bits etc. in accordance with these instructions, taking into account the working conditions and the work to be performed.** Use of the power tool for operations different from those intended could result in a hazardous situation.

Battery tool use and care

- ▶ **Recharge only with the charger specified by the manufacturer.** A charger that is suitable for one type of battery pack may create a risk of fire when used with another battery pack.
- ▶ **Use power tools only with specifically designated battery packs.** Use of any other battery packs may create a risk of injury and fire.
- ▶ **When battery pack is not in use, keep it away from other metal objects, like paper clips, coins, keys, nails, screws or other small metal objects, that can make a connection from one terminal to another.** Shorting the battery terminals together may cause burns or a fire.
- ▶ **Under abusive conditions, liquid may be ejected from the battery; avoid contact. If contact accidentally occurs, flush with water. If liquid contacts eyes, additionally seek medical help.** Liquid ejected from the battery may cause irritation or burns.

Service

- ▶ **Have your power tool serviced by a qualified repair person using only identical replacement parts.** This will ensure that the safety of the power tool is maintained.

2.2 Additional safety instructions, remote control unit



The remote control unit complies with all the requirements of the applicable directives, but Hilti cannot entirely rule out the possibility of interference caused by powerful electromagnetic radiation affecting the remote control unit, possibly leading to incorrect operation.

Check accuracy by taking measurements by other means when working under such conditions, or if you are unsure.

- ▶ Never tamper with or modify the remote control unit in any way.
- ▶ Acclimatize the remote control unit before using it.
 - ◀ Big differences in temperature can lead to incorrect operation.
- ▶ Check at the location whether the use of wireless devices is permitted. The use of wireless devices is prohibited in some locations.
- ▶ Do not use the cable of the remote control unit for purposes for which it is not intended. Never lift the remote control unit by the cable. When unplugging the cable of the remote control unit, pull the plug, not the cable.
- ▶ Carry the remote control unit with you at all times while the saw is cutting.
- ▶ Press the EMERGENCY STOP button if a hazardous situation occurs.
- ▶ When using the **Cut Assist** function, keep the sawing operation under close observation at all times and make sure that no-one enters the danger zone.
- ▶ Always press the EMERGENCY STOP button when cutting is finished or interrupted, and for all cleaning and maintenance work.
- ▶ Keep power cords and the cable of the remote control unit away from oil, sharp edges and sources of heat.
- ▶ The specified operating and storage temperatures must be observed.
- ▶ Protect the electrical contacts on the remote control unit, charger and battery from moisture.
- ▶ Do not touch the contacts.
- ▶ Dry the device before stowing it in the transport container.



2.3 Battery use and care

- ▶ Observe the special regulations and instructions applicable to the transport, storage and use of Li-ion batteries.
- ▶ Do not expose batteries to high temperatures, direct sunlight or fire.
- ▶ Do not disassemble, crush or incinerate batteries and do not subject them to temperatures over 80 °C.
- ▶ Do not attempt to charge or continue to use damaged batteries.
- ▶ If the battery is too hot to touch it may be defective. In this case, place the product in a non-flammable location, well away from flammable materials, where it can be kept under observation and allowed to cool down. Contact **Hilti Service** after the battery has cooled down.

3 Description

3.1 Product overview

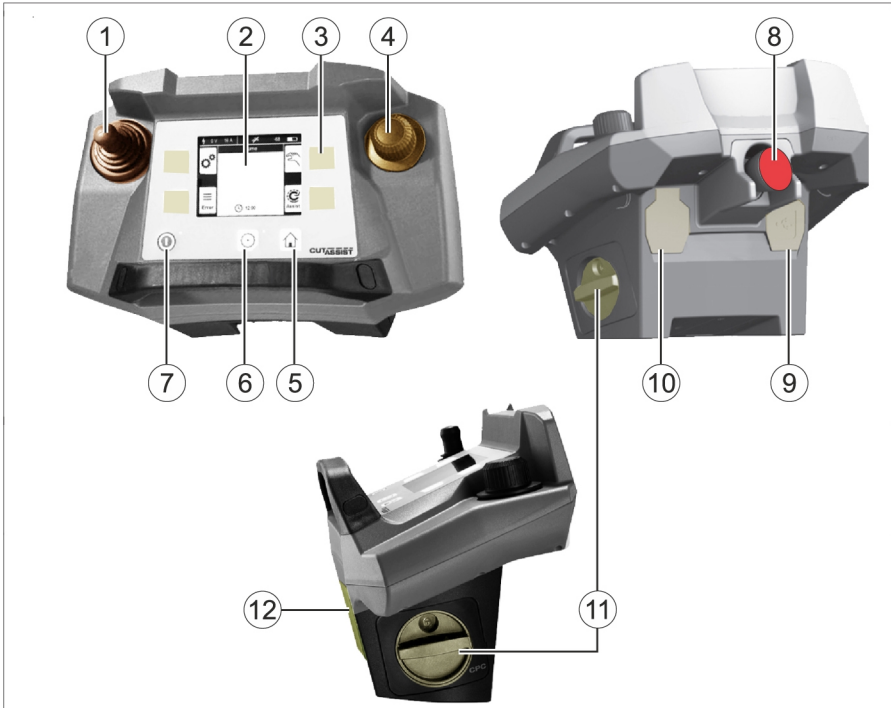

- | | |
|---|---------------------------------------|
| ① Joystick | ⑦ ON/OFF button with indicator lamp |
| ② Display | ⑧ EMERGENCY STOP |
| ③ Softkeys | ⑨ Data cable socket |
| ④ Control knob | ⑩ Connection for remote control cable |
| ⑤ HOME button | ⑪ Battery with locking mechanism |
| ⑥ DRIVE ON/OFF button with indicator lamp | ⑫ Strap attachment point |



3.2 Information content of display and status bar

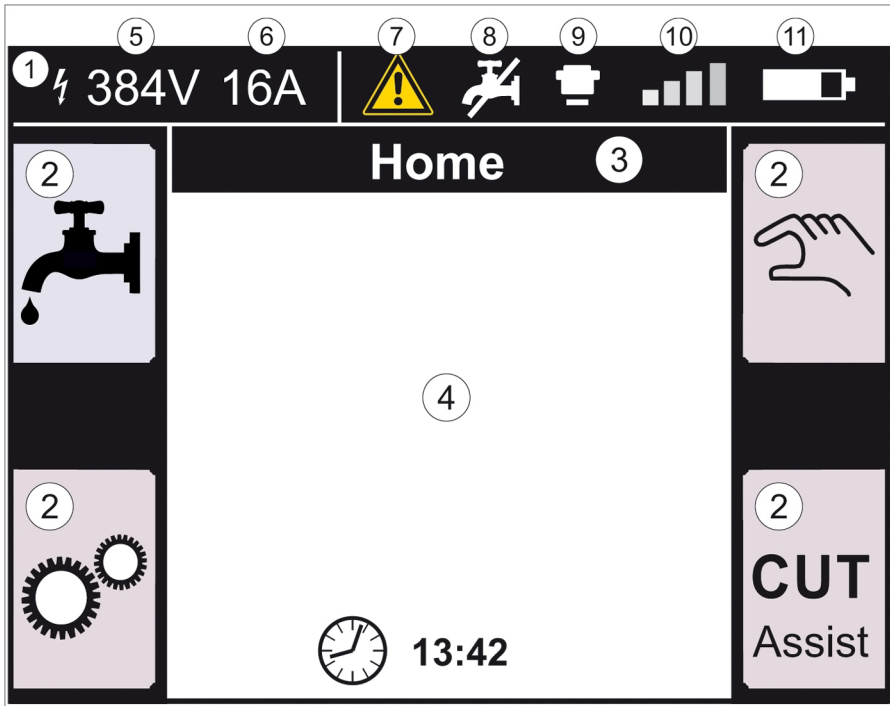

- | | | | |
|---|--|---|---|
| ① | Status bar | ⑦ | Hazard symbol
yellow => message red => malfunction |
| ② | Symbols for function activated | ⑧ | Water supply on / off |
| ③ | Screen title | ⑨ | EMERGENCY STOP button pressed |
| ④ | Function-specific information | ⑩ | Wireless connection signal strength
or symbol for cable connection |
| ⑤ | Voltage measured at the partner device | ⑪ | Battery charge state |
| ⑥ | Value set for mains fuse rating | | |

3.3 Intended use

The product described is a remote control that can be used for operating certain **Hilti** products by wireless or cable remote control. When the cable is used the wireless connection is deactivated.

- ▶ Use this product only with **Hilti** Li-ion batteries of the PRA 84 and PRA 84 G series and the PUA 81 battery charger designed for these batteries.

3.4 Cut Assist

The **Cut Assist** technology enables various work steps to be automated.

When a product features this technology the assistant undertakes certain functions, optimizes and automatically performs them.

3.5 Joystick

Use the joystick to control the direction of advance.

For safety reasons, the preset for speed of advance is zero.

- Advance 1: Joystick forward or back
- Advance 2: Joystick to left or right

i After you switch on the remote control unit, in order to start the first advance you have to turn the control knob clockwise at the same time as you operate the joystick.

3.6 Control knob

The control knob enables you to select the following functions:



- Set drive parameters.
- Select a preset or set a value in the "Settings".

If a value can be selected or set by turning the control knob, the control knob symbol  appears alongside the value or the selectable settings.

3.7 EMERGENCY STOP

It is permissible to enter the danger zone after the **EMERGENCY STOP** button has been pressed.













3.8 Buttons/keys on the remote control unit

	ON/OFF When the button is pressed it lights up green and the Home screen appears on the display. The remote control unit is ready for use. To switch off, press and hold down until the display goes blank and the green light goes out.
	DRIVE ON / OFF When the button is pressed it lights up green and the drive starts. Short-press to switch off.
	HOME Shows the Home screen.

3.9 Function buttons

The buttons on the left and right of the display are function keys of the screen-labeled softkey type. The function assigned to each softkey at any given time is indicated by the corresponding symbol that appears on the display.

3.10 Parameter settings <...>

	Mains fuse rating		Cutting parameters
	Saw blade diameter		Automatic cooling water control
	Password		Country, language, unit of measurement
	Date and time		Display brightness
	Messages		System information
	Logbook		Service indicator

3.11 Functions <<...>>

	Settings		Settings with the control knob
---	----------	---	--------------------------------



	Up		Down
	Next		OK
	Add data record		Delete data record
	Continue		Back
	Cut Assist		Manual mode
	Set operating hours to zero		List of blade diameters
	Turn cooling water ON		Turn cooling water OFF
	Define obstacle		Overcut
	Stop/hold		Stop/pause
	Cancel without saving		•/•

3.12 Items supplied

DST WRC-CA

1	Remote control unit	1	Remote control unit operating instructions
1	Strap	2	Battery
1	Charger	1	Remote control cable
1	Case	1	Angle piece (optional)

Other system products approved for use with this product can be found at your local **Hilti Store** or online at: www.hilti.group | USA www.hilti.com.

4 Technical data

4.1 Remote control unit

	DST WRC-CA
Supply voltage	24 V
Protection class in accordance with IEC 60529	IP 65
Weight	3.5 lb (1.6 kg)
Dimensions (L×W×H)	11.0 in × 6.3 in × 7.5 in (280 mm × 160 mm × 190 mm)
Length of the remote control cable	26 ft (8 m)

4.2 Wireless communication (between the DST WRC-CA remote control unit and wall/diamond saw)

Frequency band	2,400 MHz ...2,483.5 MHz
Maximum emitted transmission power	10,9 dBm
Range	65 ft - 10 in (20 m)

4.3 PUA 81 charger

Rated supply current	115 V ...230 V
AC frequency	47 Hz ...63 Hz
Rated power	36 VA
Rated voltage	12 V
Operating temperature	32 °F ... 104 °F (0 °C ...40 °C)
Storage temperature (dry)	-13 °F ...140 °F (-25 °C ...60 °C)
Charging temperature	32 °F ... 104 °F (0 °C ...40 °C)

4.4 PRA 84 Li-ion battery

Rated voltage	7.2 V ... 13 V
Rated current	120 mA
Capacity	4.5 Ah
Charging time	2 h
Operating temperature	-4 °F ... 122 °F (-20 °C ...50 °C)
Storage temperature (dry)	-13 °F ...140 °F (-25 °C ...60 °C)
Charging temperature	32 °F ... 104 °F (0 °C ...40 °C)

4.5 PRA 84 G Li-ion battery

Rated voltage	7.2 V ... 13 V
Rated current	270 mA
Capacity	6 Ah
Charging time	3 h
Operating temperature	-4 °F ... 122 °F (-20 °C ...50 °C)
Storage temperature (dry)	-13 °F ...140 °F (-25 °C ...60 °C)
Charging temperature	32 °F ... 104 °F (0 °C ...40 °C)

4.6 Interfaces

Service interface	USB
Socket for remote control cable	Bayonet socket

5 Preparations at the workplace

CAUTION

Risk of damage due to severe heat !

- ▶ Always remove the battery from the remote control unit for charging.

- ▶ Charge the battery fully before using it for the first time.

5.1 Removing the battery

1. Turn the catch in a counter-clockwise direction until the “unlocked” symbol appears.
2. Remove the battery from the slot in the remote control unit.

5.2 Charging the battery

1. Connect the plug of the charger to the battery.
2. Plug the battery charger's supply cord into a power outlet.
 - ◀ The red LED on the battery lights while charging is in progress. The battery is fully charged as soon as the red LED goes out.

5.3 Inserting the battery

1. Push the battery into the slot in the remote control unit.
2. Turn the catch in a clockwise direction until the “locked” symbol appears.

5.4 Pairing the remote control unit and partner device

Before a product can be operated for the first time as a partner device with the remote control unit, the product and the remote control unit have to be paired. See also the operating instructions of the partner device.

1. Connect the remote control unit and the partner device with the remote control cable.
2. Connect the partner device to the electricity supply.
3. Make sure that the **EMERGENCY STOP** button on the remote control unit is disengaged.
4. Switch the remote control unit on. As soon as the remote control unit detects a partner device connected by remote control cable, a message notifying the operator to this effect is issued.
5. Follow the step-by-step instructions displayed on the remote control unit. Always switch the remote control unit off before disconnecting the remote control cable.

5.5 Setting the language, country and unit of measure

The settings for country and language are independent of each other. When it is switched on for the first time, the unit prompts for a language to be selected.

1. On the **HOME** screen, select <<Settings>>.
2. Select <Country, language, unit of measure> and confirm your choice with <<OK>>.
3. Turn the control knob to select the language of your choice.
4. Use <<OK>> to confirm your settings.
 - ◀ After your first successful log-on you will not have to repeat this step when you make changes.
5. Use <<Down>> to proceed to the setting for country.
 - ◀ Use the control knob to select the appropriate three-letter country code.
6. Use <<Down>> to proceed to the setting for unit of measure.
 - ◀ Turn the control knob to select the unit of measure of your choice.
7. Use <<OK>> to confirm your settings.

5.6 Setting the line fuse rating

1. On the **HOME** screen, select <<Settings>>.
2. Select <Line fuse rating> and press <<OK>>.

3. Use the control knob to select the fuse rating for the electricity supply (A).
4. Use the <<Down>> button to proceed to the next setting.
5. Use the control knob to set the line attenuation.
6. Use <<OK>> to confirm your settings.
 - ◀ The settings will be saved and the fuse rating then displayed in the status bar in the display.



Certain line configurations (e.g. extension cables) can cause recurrent appearances of the "Overload shutdown" message. If this happens, change the line attenuation setting.

5.7 Setting the cutting parameters

1. On the **HOME** screen, select <<Settings>>.
2. Select <Cutting parameters> and press <<OK>>.
3. Enter the password and press <<OK>>.
4. Use the control knob to set the desired cutting speed.
5. Use the <<Down>> button to proceed to the next setting.
6. Use the control knob to set the desired depth for the pilot cut.
7. Use the <<Down>> button to proceed to the next setting.
8. Use the control knob to set the desired depth for the follow-up cut.
9. Use the <<Down>> button to proceed to the next setting.
10. Use the control knob to set performance for the pilot cut.
11. Use <<OK>> to confirm your settings.

5.8 Saw blade diameter and blade guard

Saw blades are managed together with the corresponding blade guards. The data records are listed by blade guard diameter in ascending order.
Data records can be added, changed or deleted.

5.8.1 Setting the diameter of the saw blade and the blade guard

1. On the **HOME** screen, select <<Settings>>.
2. Select <Diameter saw blade> and confirm your choice with <<OK>>.
3. Use the <<Down>> button to go to the end of the list, where you will find a saw blade and blade guard combination for which no values have been entered.
4. Use the <<Add data record>> button to add the new saw blade/blade guard pair to the list.
5. Use the control knob to set the diameter of the new saw blade.
6. Use the <<Down>> button to select the corresponding blade guard.
7. Use the control knob to select the corresponding blade guard.
8. If no further changes are intended, Use <<OK>> to confirm your settings.

5.8.2 Changing the diameter of the saw blade or blade guard

1. On the **HOME** screen, select <<Settings>>.
2. Select <Diameter saw blade> and confirm your choice with <<OK>>.
3. Use <<Down>> or <<Up>> as appropriate to select the diameter of the saw blade or the blade guard.
4. Use the control knob to change the diameter of the saw blade or the blade guard.
5. Use <<OK>> to confirm your settings.

5.8.3 Removing the saw blade diameter with blade guard from the list

1. On the **HOME** screen, select <<Settings>>.
2. Select <Diameter saw blade> and confirm your choice with <<OK>>.
3. Use <<Down>> or <<Up>> as appropriate to select the diameter of the saw blade or the blade guard.
4. Delete the settings with <<Remove data record>>.
5. Use <<OK>> to confirm your settings.

5.9 Activating cooling water control

1. On the **HOME** screen, select <<Settings>>.
2. Select <Cooling water control> and confirm your choice with <<OK>>.
3. Use the control knob to select manual or automatic cooling water control.



4. Use <<OK>> to confirm your settings.

5.10 Changing the password

1. On the **HOME** screen, select <<Settings>>.
2. Select <Password> and confirm your choice with <<OK>>.
3. Use the control knob to enter the old password digit by digit.
 - ◀ If you have forgotten the password, you have to reset to the default settings.
4. Confirm the old password with <<OK>>.
 - ◀ The **Change password** screen appears on the display.
5. Use the <<Next>> button to proceed to the next setting.
6. Use the control knob to enter the new password digit by digit.
7. Use <<OK>> to confirm your settings.

5.11 Setting screen brightness

1. On the **HOME** screen, select <<Settings>>.
2. Select <Screen brightness> and confirm your choice with <<OK>>.
3. Use the control knob to set the desired screen brightness.
4. Use <<OK>> to confirm your settings.

5.12 Setting the date and time

1. On the **HOME** screen, select <<Settings>>.
2. Select <Date and time> and confirm your choice with <<OK>>.
3. Use the control knob to set the hour.
4. Use the <<Next>> button to proceed to the next field.
5. Use the control knob to set the minutes.
6. Use the <<Next>> button to proceed to the next field.
7. Use the control knob to set the calendar year.
8. Use the <<Next>> button to proceed to the next field.
9. Use the control knob to select the calendar month.
10. Use the <<Next>> button to proceed to the next field.
11. Use the control knob to select the calendar day.
12. Use <<OK>> to confirm your settings.

5.13 Reading messages



This screen shows you the messages stored in memory.

1. On the **HOME** screen, select <<Settings>>.
2. Select <Messages> and confirm your choice with <<OK>>.
3. Use <<Down>> or <<Up>> as appropriate to select an entry from the list of messages.
4. Press <<OK>> to view the message you selected.
 - ◀ The message will be displayed.
5. Press <<OK>> to return to the overview list of messages.

5.14 Reading the logbook



This screen tells you how many operating hours in manual mode and assisted mode have been logged since the operating hours were last zeroed.

1. On the **HOME** screen, select <<Settings>>.
2. Select <Logbook> and confirm your choice with <<OK>>.
3. Use <<Down>> or <<Up>> as appropriate to select the detailed log of manual mode or assisted mode.
4. Press <<OK>> to view the detailed logs of the most recent cuts.

5.15 Technical information and next service

 This screen tells you about operating hours logged, the operating-hours countdown until the next service is due, serial numbers and version numbers of the hardware and the software.

1. On the **HOME** screen, select <<Settings>>.
2. Select <Service indicator> and confirm your choice with <<OK>>.
3. Use <<Down>> or <<Up>> as appropriate to proceed to the next screen.
4. Use <<Back>> to exit the screen.

5.16 Resetting the settings

1. Press the **HOME** button.
2. Press and hold down the **HOME** button until the **Reset settings** screen appears on the display.
3. Use <<OK>> to reset the remote control unit to the factory default settings or exit the screen with <<Cancel without saving>>.
 - ◀ The pairing information for the partner device is not deleted.

6 Manual operation

6.1 Overview

In manual-mode cutting the operator makes all the settings, both before and during cutting.

Measure the outside diameter of the saw blade before installing it. The diameter you enter influences blade speed of rotation and depth and length of the cut. Installation of the rail, choice of country and system tolerances influence depth and length of the cut.

Note that the actual depth and length of cut can differ considerably from the values shown or set.

6.2 Cutting with the wall saw in manual mode

1. Press the **ON/OFF** button.
 - ◀ The button lights up green and the **Home** screen appears on the display.
 - ◀ The remote control unit is ready for use.
2. Select <<Manual mode>>.
 - ◀ The **Saw blade** screen appears on the display.
3. Use the control knob to select the saw blade diameter.
4. Position the saw head for the start.
 - ◀ To do so, push the joystick up or down and hold it in this position, while at the same time using the control knob to set the advance speed.

 You can also change the setting for the saw-blade diameter by turning the control knob without pushing the joystick at the same time. If you hold the joystick in one position for about five seconds the advance movement is accepted as the setting for constant advance. This applies only to advance, not to cutting depth. You can release the joystick and allow the saw to travel to the intended position.

Briefly move the joystick as soon as the saw head reaches the desired position.

5. Press the **DRIVE ON/OFF** button.
 - ◀ The drive of the saw blade starts.
6. If automatic cooling water control is not activated, turn on the cooling water with <<Turn cooling water ON>>.
7. Move the joystick to the left or right to start cutting and at the same time turn the control knob to adjust performance. Release the joystick as soon as the saw blade has reached the desired cutting depth. The calculated cutting depth is shown on the display on the remote control unit.
8. Push the joystick up or down to move the saw head along the rail and turn the control knob as necessary to adjust performance.
9. At the end of the cut, briefly move the joystick to stop the saw's advance.
10. Repeat steps seven through nine until the desired total depth of cut is reached.
11. Use the joystick to pivot the saw blade out of the cut to the 12 o'clock position.



12. Press the **DRIVE ON/OFF** button.
 - ◀ The drive of the saw blade stops.
13. If automatic cooling water control is not activated, turn off the cooling water with <<Turn cooling water OFF>>.
14. Move the saw head to a position in which it can easily be removed.
15. Press the **EMERGENCY STOP** button.

7 Assisted operation with Cut Assist

7.1 Overview

This remote control unit features the **Cut Assist** function. It automates various work steps.

When you select the **Cut Assist** function, you are prompted to set the parameters necessary for making the cut. Once you have entered the necessary values and started the saw-blade drive, the cut is made to a very large extent without any further intervention on your part.

If an action on your part is required, a message prompting you to take the appropriate action appears on the display.

Measure the outside diameter of the saw blade before installing it. The diameter you enter influences blade speed of rotation and depth and length of the cut.

7.2 Cutting with the wall saw in Cut Assist mode



The values for saw blade diameter and blade guard type proposed here can be defined in the <<Settings>>. Changes made to saw blade diameter and blade guard configuration are saved in the settings.

1. Press the **ON/OFF** button.
 - ◀ The button lights up green and the **Home** screen appears on the display.
 - ◀ The remote control unit is ready for use.
2. Activate assisted mode by pressing the <<Cut Assist>> button.
 - ◀ The **Saw blade and guard** screen appears on the display.
3. Use the control knob to enter the diameter of the saw blade used.
 - ◀ Changes to the nominal diameter within the ± 50 mm range are possible.
4. Use the <<Down>> button to proceed to the parameter for selecting the blade guard.
5. Turn the control knob to select the blade guard used.
6. Use <<OK>> to confirm your settings.
 - ◀ The **Depth of cut** screen appears on the display for entering the wall thickness and setting the depth of cut.
7. Use the control knob to enter the wall thickness.
8. Use the <<Down>> button to proceed to the parameter for defining the maximum depth of cut for penetration.
9. Use the control knob to enter the maximum depth of cut for penetration.
10. Use <<OK>> to confirm your settings.
 - ◀ The **Starting point** screen appears on the display. On this screen the distance from the saw head center mark to the starting point can be defined, an obstacle indicated and overcutting at the end of the cut allowed.
11. Define whether an overcut should be made at the start of the cut.
 - ◀ When overcutting, the cut is extended so that the set length of cut is also reached, as far as possible, at the reverse side of the wall being cut through.
12. Press the <<Define obstacle>> button if, within approx. 40 cm of the start of cut, there is an obstacle that would cause a collision with the blade guard.
13. Use the control knob to enter the distance between the saw head center mark and the start of the cut.
 - ◀ If the starting point of the cut is in the direction of the plus sign, as viewed from the saw head center mark, set the distance as a positive value. If the opposite is the case, set the distance as a negative value. When you define an obstacle, the plausibility of your entry defining the distance from the saw head is checked. If the value you enter is too low, it is corrected to the required minimum distance.
 - ◀ The corrected value is shown on the screen if a correction is made.

14. Use <<OK>> to confirm your settings.
 - ◀ The **Length of cut** screen appears on the display. On this screen the length of cut can be defined, an obstacle indicated and overcutting at the end of the cut allowed.
15. Define whether an overcut is allowed at the end of the cut.
 - ◀ When overcutting, the cut is extended so that the set length of cut is also reached, as far as possible, at the reverse side of the wall being cut through.
16. Press the <<Define obstacle>> button if, within approx. 40 cm of the end of cut, there is an obstacle that would cause a collision with the blade guard.
 - ◀ The length of cut entered is checked for plausibility and corrected to the lowest possible value. The corrected value is shown on the screen if a correction is made.
17. Use the control knob to set the length of cut.
18. Use <<OK>> to confirm your settings.
 - ◀ The **Cutting overview** screen appears on the display so that you can check your settings. The number of saw blades required and the number of cuts are shown at the bottom of the screen.
19. Press the <<Back>> button if you have to make corrections to the entries.
20. When you are satisfied that all the entries are correct, press the **DRIVE ON/OFF** but to start cutting in Cut Assist mode.



If necessary, adjustments can be made to the cutting depth, performance and rotary speed while cutting is in progress.

The saw blade will be lifted out of the cut as soon as the cut is completed. The flow of water and the drive are switched off. The area of the cut and cutting time are shown for the cut being made. Use Settings/Logbook to call up the history of the most recent cuts.

7.3 Interrupting an assisted cut

An assisted cut can be paused, interrupted for a break, or canceled completely.

7.3.1 Pausing the cut and resuming in manual mode

1. Press the <<Stop/hold>> button.
 - ◀ Saw head advance is interrupted and cutting is paused, but the saw blade continues to rotate.
 - ◀ The **Cut Assist in progress** screen appears on the display, the system is in the paused state.
2. Press the <<Manual mode>> button.
 - ◀ The **Manual mode** screen appears on the display.
3. Resume cutting in manual mode, see the section headed **Cutting with the wall saw in manual mode** → page 14.

7.3.2 Interrupting a cut

1. Press the <<Stop/Hold>> button.
 - ◀ Saw head advance is interrupted and cutting is paused, but the saw blade continues to rotate.
 - ◀ The pause screen is displayed.
2. Press the <<Stop/pause>> button.
 - ◀ The saw blade lifts out of the cut and stops rotating. The **Cut Assist in progress** screen is grayed.
3. Press the **EMERGENCY STOP** button.
 - ◀ It is permissible for the operator to enter the danger zone.



Before you resume cutting in **Cut Assist** mode by pressing the **DRIVE ON/OFF** button or switch to <<Manual mode>>, you have to disengage the **EMERGENCY STOP** button.

7.4 Changing the saw blade



If a larger saw blade is needed during a wall-saw cut in Cut Assist mode, the saw arm pivots out of the cut, the saw blade slows to a stop and the **Change blade** screen appears.

1. Press the **EMERGENCY STOP** button.
2. Install a saw blade of the next biggest diameter, along with the corresponding blade guard.



3. Use the control knob to set the outside diameter of the saw blade and the blade guard.
 - ◀ The outside diameter you enter influences blade speed of rotation and the depth and length of the cut.
4. Disengage the **EMERGENCY STOP** button.
5. Use <<OK>> to confirm your entries.
 - ◀ The **Cut Assist in progress** screen is grayed.
6. Press the **DRIVE ON/OFF** button to resume cutting.
 - ◀ The **Cut Assist in progress** screen appears on the display.

7.5 Configuring the blade guard



When an obstacle defined beforehand is reached while the saw is cutting in Cut Assist mode, advance movement stops. The saw blade continues to rotate and the screen for configuring the blade guard appears on the display.

1. Press <<OK>>.
 - ◀ The saw blade lifts out of the cut and stops rotating. The "Configure guard" prompt appears in the dialog on the display.
2. Press the **EMERGENCY STOP** button.
3. Configure the blade guard to suit the obstacle.
4. Secure the danger zone in the area of the segment removed.
5. Make sure there is no-one in the danger zone.
6. Disengage the **EMERGENCY STOP** button.
7. Use <<OK>> to confirm that the blade guard has been configured.
 - ◀ The **Cut Assist in progress** screen is grayed.
8. Press the **DRIVE ON/OFF** button to resume cutting.
 - ◀ If the cut is completed without further intervention on the part of the operator, the **CUT Assist completed** screen appears. The **Reassemble guard** screen appears if further action on the part of the operator is required.

8 Care and maintenance of cordless tools



WARNING

Risk of injury with battery inserted !

- ▶ Always remove the battery before carrying out care and maintenance tasks!

Care and maintenance of the tool

- Carefully remove stubborn dirt from the tool.
- Use only a slightly damp cloth to clean the casing. Do not use cleaning agents containing silicone as these can attack the plastic parts.

Care of the Li-ion batteries

- Keep the battery free from oil and grease.
- Use only a slightly damp cloth to clean the casing. Do not use cleaning agents containing silicone as these can attack the plastic parts.
- Avoid ingress of moisture.

Maintenance

- Check all visible parts and controls for signs of damage at regular intervals and make sure that they all function correctly.
- Do not operate the cordless tool if signs of damage are found or if parts malfunction. Have the tool repaired by **Hilti** Service immediately.
- After cleaning and maintenance, fit all guards or protective devices and check that they function correctly.



9 Transport and storage of cordless tools

Transport

CAUTION

Accidental starting during transport !

- ▶ Always transport your products with the batteries removed!
- ▶ Remove the battery.
- ▶ Transport the tool and batteries individually packaged.
- ▶ Never transport batteries in bulk form (loose, unprotected).
- ▶ Check the tool and batteries for damage before use after long periods of transport.

Storage

CAUTION

Accidental damage caused by defective or leaking batteries !

- ▶ Always store your products with the batteries removed!
- ▶ Store the tool and batteries in a place that is as cool and dry as possible.
- ▶ Never store batteries in direct sunlight, on heating units or behind a window pane.
- ▶ Store the tool and batteries in a place where they cannot be accessed by children or unauthorized persons.
- ▶ Check the tool and batteries for damage before use after long periods of storage.

10 Troubleshooting

If the trouble you are experiencing is not listed in this table or you are unable to remedy the problem by yourself, please contact Hilti Service.

Trouble or fault	Possible cause	Action to be taken
The remote control unit refuses to switch on or the screen remains dark.	The battery is discharged	<ul style="list-style-type: none"> ▶ Change the battery and charge the empty battery. ▶ Work with the remote control cable. ▶ Contact HILTI service.
Failure of the remote control unit and/or screen to respond to user inputs.	Software fault	<ul style="list-style-type: none"> ▶ Switch off the electricity supply to the remote control unit and the partner device and restart. ▶ Contact HILTI service.
Cutting parameters cannot be changed.	Password forgotten	<ul style="list-style-type: none"> ▶ Contact HILTI service.

11 Disposal

Most of the materials from which **Hilti** tools and appliances are manufactured can be recycled. The materials must be correctly separated before they can be recycled. In many countries, your old tools, machines or appliances can be returned to **Hilti** for recycling. Ask **Hilti** Service or your Hilti representative for further information.

Battery disposal

Improper disposal of batteries can result in health hazards from leaking gases or fluids.

- ▶ DO NOT send batteries through the mail!
- ▶ Cover the terminals with a non-conductive material (such as electrical tape) to prevent short circuiting.
- ▶ Dispose of your battery out of the reach of children.
- ▶ Dispose of the battery at your **Hilti Store**, or consult your local governmental garbage disposal or public health and safety resources for disposal instructions.



- ▶ Do not dispose of power tools, electronic equipment or batteries as household waste!



12 Manufacturer's warranty

- ▶ Please contact your local **Hilti** representative if you have questions about the warranty conditions.

13 FCC statement (applicable in US) / IC statement (applicable in Canada)

This device complies with Part 15 of the FCC Rules and RSS-210 of IC. Operation is subject to the following two conditions:

1. this device may not cause harmful interference, and
2. this device must accept any interference received, including interference that may cause undesired operation.





This Product is Certified
Ce produit est homologué
Producto homologado por
Este producto está registrado





Hilti Corporation
LI-9494 Schaan
Tel.: +423 234 21 11
Fax: +423 234 29 65
www.hilti.com

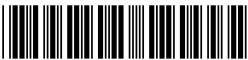

2053458