



HILTI HIT-HY 170 INJECTION MORTAR

ETA-15/0197 (09.12.2015)



English	2-27
Deutsch	29-54
Français	56-81
Polski	83-114

Approval body for construction products
and types of construction

Bautechnisches Prüfamt

An institution established by the Federal and
Laender Governments



European Technical Assessment

ETA-15/0197
of 9 December 2015

English translation prepared by DIBt - Original version in German language

General Part

Technical Assessment Body issuing the
European Technical Assessment:

Deutsches Institut für Bautechnik

Trade name of the construction product

Injection system Hilti HIT-HY 170

Product family
to which the construction product belongs

Injection system for use in masonry

Manufacturer

Hilti AG
Feldkircherstraße 100
9494 Schaan
FÜRSTENTUM LIECHTENSTEIN

Manufacturing plant

Hilti Werke

This European Technical Assessment
contains

26 pages including 3 annexes which form an integral part
of this assessment

This European Technical Assessment is
issued in accordance with Regulation (EU)
No 305/2011, on the basis of

Guideline for European technical approval of "Metal
Injection Anchors for Use in Masonry", ETAG 029,
April 2013,
used as European Assessment Document (EAD)
according to Article 66 Paragraph 3 of Regulation (EU)
No 305/2011.

This version replaces

ETA-15/0197 issued on 28 April 2015

The European Technical Assessment is issued by the Technical Assessment Body in its official language. Translations of this European Technical Assessment in other languages shall fully correspond to the original issued document and shall be identified as such.

Communication of this European Technical Assessment, including transmission by electronic means, shall be in full. However, partial reproduction may only be made with the written consent of the issuing Technical Assessment Body. Any partial reproduction shall be identified as such.

This European Technical Assessment may be withdrawn by the issuing Technical Assessment Body, in particular pursuant to information by the Commission in accordance with Article 25(3) of Regulation (EU) No 305/2011.

1 Technical description of the product

The Injection system Hilti HIT-HY 170 for masonry is a bonded anchor (injection type) consisting of a mortar foil pack with injection mortar Hilti HIT-HY 170, a perforated sieve sleeve and an anchor rod with hexagon nut and washer in the range of M8 to M12 or an internal threaded sleeve in the range of M8 to M12. The steel elements are made of zinc coated steel, stainless steel or high corrosion resistant steel.

The anchor rod is placed into a drilled hole filled with injection mortar and is anchored via the bond and/or mechanical interlock between steel element, injection mortar and masonry.

The product description is given in Annex A.

2 Specification of the intended use in accordance with the applicable European Assessment Document

The performances given in Section 3 are only valid if the anchor is used in compliance with the specifications and conditions given in Annex B.

The verifications and assessment methods on which this European Technical Assessment is based lead to the assumption of a working life of the anchor of at least 50 years. The indications given on the working life cannot be interpreted as a guarantee given by the producer, but are to be regarded only as a means for choosing the right products in relation to the expected economically reasonable working life of the works.

3 Performance of the product and references to the methods used for its assessment

3.1 Mechanical resistance and stability (BWR 1)

Essential characteristic	Performance
Characteristic resistance for steel elements	See Annex C2
Characteristic resistance for anchors in masonry units	See Annex C3 – C8
Displacements under shear and tension loads	See Annex C3 – C8
Reduction Factor for job site tests (β -Factor)	See Annex C1
Edge distances and spacing	See Annex C3 – C8
Group factor for group fastenings	See Annex C3 – C8

3.2 Safety in case of fire (BWR 2)

Essential characteristic	Performance
Reaction to fire	Class A1
Resistance to fire	No performance assessed

3.3 Hygiene, health and the environment (BWR 3)

Regarding dangerous substances there may be requirements (e.g. transposed European legislation and national laws, regulations and administrative provisions) applicable to the products falling within the scope of this European Technical Assessment. In order to meet the provisions of Regulation (EU) No 305/2011, these requirements need also to be complied with, when and where they apply.

3.4 Safety in use (BWR 4)

The essential characteristics regarding Safety in use are included under the Basic Works Requirement Mechanical resistance and stability.

4 Assessment and verification of constancy of performance (AVCP) system applied, with reference to its legal base

In accordance with guideline for European technical approval ETAG 029, April 2013 used as European Assessment Document (EAD) according to Article 66 Paragraph 3 of Regulation (EU) No 305/2011 the applicable European legal act is: [97/177/EC].

The system to be applied is: 1

5 Technical details necessary for the implementation of the AVCP system, as provided for in the applicable European Assessment Document

Technical details necessary for the implementation of the AVCP system are laid down in the control plan deposited at Deutsches Institut für Bautechnik.

Issued in Berlin on 9 December 2015 by Deutsches Institut für Bautechnik

Uwe Bender
Head of Department

beglaubigt:
Wittstock

Installed condition

Figure A1: Hollow and solid brick with threaded rod, HIT-V-... and sieve sleeve HIT-SC (see Table B5) or with internally threaded sleeve HIT-IC and sieve sleeve HIT-SC (see Table B6)

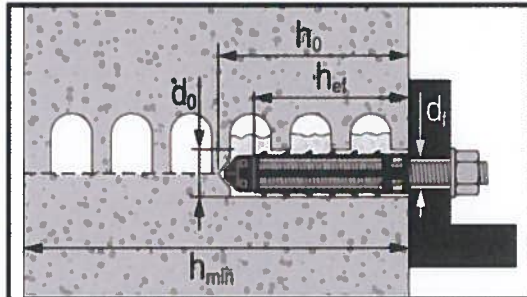

Figure A2: Solid brick with threaded rod, HIT-V-... (see Table B7)

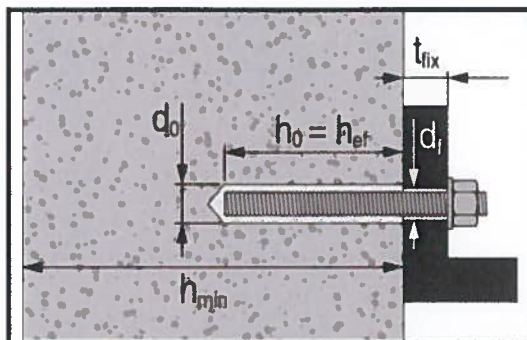
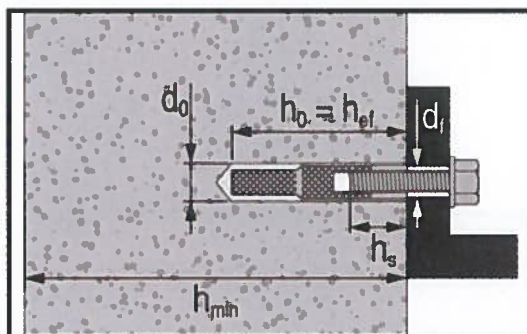

Figure A3: Solid brick with internally threaded sleeve HIT-IC (see Table B8)



<p>Hilti HIT-HY 170</p>	
<p>Product description Installed condition.</p>	<p>Annex A1</p>

Product description: Injection mortar and steel elements

**Injection mortar Hilti HIT-HY 170: hybrid system with aggregate
330 ml and 500 ml**

Marking
HILTI HIT
Production number and
production line
Expiry date mm/yyyy



Product name: "Hilti HIT-HY 170"

Static mixer Hilti HIT-RE-M



Threaded rod, HIT-V-...: M8 to M12

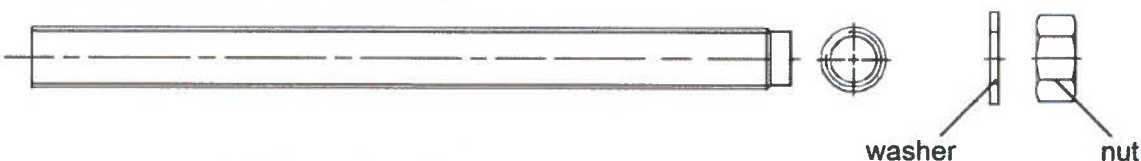

Commercial standard threaded rod with:

- Materials and mechanical properties according to Table A1.
- Inspection certificate 3.1 according to EN 10204:2004. The documents shall be stored.
- Marking of embedment depth.

Internally threaded sleeve: HIT-IC M8 to M12



Marking:
e. g. HIT-IC M8x80

Sieve sleeve: HIT-SC 16 to 22

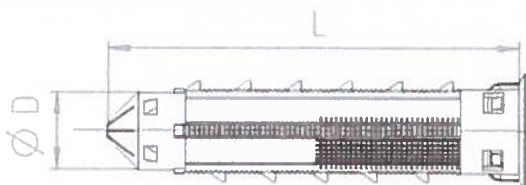

Head marking:
e. g. HIT-SC 18x85

Hilti HIT-HY 170	Annex A2
Product description Injection mortar / Static mixer / Steel elements / Sieve sleeve.	

Table A1: Materials

Designation	Material
Metal parts made of zinc coated steel	
Threaded rod HIT-V-5.8(F)	Strength class 5.8, $f_{uk} = 500 \text{ N/mm}^2$, $f_{yk} = 400 \text{ N/mm}^2$. Elongation at fracture ($l_0 = 5d$) > 8% ductile. Electroplated zinc coated $\geq 5 \mu\text{m}$, (F) Hot dip galvanized $\geq 45 \mu\text{m}$.
Threaded rod HIT-V-8.8(F)	Strength class 8.8, $f_{uk} = 800 \text{ N/mm}^2$, $f_{yk} = 640 \text{ N/mm}^2$. Elongation at fracture ($l_0 = 5d$) > 8% ductile. Electroplated zinc coated $\geq 5 \mu\text{m}$, (F) Hot dip galvanized $\geq 45 \mu\text{m}$.
Internally threaded sleeve HIT-IC	$f_{uk} = 490 \text{ N/mm}^2$, $f_{yk} = 390 \text{ N/mm}^2$. Elongation at fracture ($l_0 = 5d$) > 8% ductile. Electroplated zinc coated $\geq 5 \mu\text{m}$.
Washer	Electroplated zinc coated $\geq 5 \mu\text{m}$. Hot dip galvanized $\geq 45 \mu\text{m}$.
Nut	Strength class of nut adapted to strength class of threaded rod. Electroplated zinc coated $\geq 5 \mu\text{m}$, (F) Hot dip galvanized $\geq 45 \mu\text{m}$.
Metal parts made of stainless steel	
Threaded rod HIT-V-R	Strength class 70 $f_{uk} = 700 \text{ N/mm}^2$, $f_{yk} = 450 \text{ N/mm}^2$. Elongation at fracture ($l_0 = 5d$) > 8% ductile. Stainless steel 1.4401, 1.4404, 1.4578, 1.4571, 1.4439, 1.4362 EN 10088-1:2014.
Washer	Stainless steel 1.4401, 1.4404, 1.4578, 1.4571, 1.4439, 1.4362 EN 10088-1:2014.
Nut	Strength class of nut adapted to strength class of threaded rod Stainless steel 1.4401, 1.4404, 1.4578, 1.4571, 1.4439, 1.4362 EN 10088-1:2014.
Metal parts made of high corrosion resistant steel	
Threaded rod HIT-V-HCR	$f_{uk} = 800 \text{ N/mm}^2$, $f_{yk} = 640 \text{ N/mm}^2$. Elongation at fracture ($l_0 = 5d$) > 8% ductile. High corrosion resistant steel 1.4529, 1.4565 EN 10088-1:2014.
Washer	High corrosion resistant steel 1.4529, 1.4565 EN 10088-1:2014.
Nut	Strength class of nut adapted to strength class of threaded rod. High corrosion resistant steel 1.4529, 1.4565 EN 10088-1:2014.
Plastic parts	
Sieve sleeve HIT-SC	Frame: FPP 20T. Sieve: PA6.6 N500/200.

Hilti HIT-HY 170

Product description
Materials.

Annex A3

Specifications of intended use

Base materials:

- Solid brick masonry (use category b) according to Annex B3.
Note: The characteristic resistances are also valid for larger brick sizes and larger compressive strengths of the masonry unit.
- Hollow brick masonry (use category c) according to Annex B3 and B5.
- Mortar strength class of the masonry: M2,5 at minimum according to EN 998-2:2010.
- For masonry made of other solid, hollow or perforated bricks, the characteristic resistance of the anchor may be determined by job site tests according to ETAG 029, Annex B under consideration of the β -factor given in Annex C1, Table C1.

Table B1: Overview use categories

Anchorages subject to:		HIT-HY 170 with threaded rod, HIT-V-... or HIT-IC	
		in solid bricks	in hollow bricks
Hole drilling		hammer mode	rotary mode
Static and quasi static loading		Annex: C2 (steel), C3, C4	Annex: C2 (steel), C5, C6, C7, C8
Use category: dry or wet structure		Category d/d - Installation and use in structures subject to dry internal conditions. Category w/d - Installation in dry or wet substrate and use in structures subject to dry internal conditions Category w/w - Installation and use in structures subject to dry or wet environmental conditions	
Installation direction		horizontal	
Use category		b (solid masonry)	c (hollow or perforated masonry)
Temperature in the base material at installation		+5 °C to +40 °C (Table B9)	-5 °C to +40 °C (Table B10)
In-service temperature	Temperature range Ta:	-40 °C to +40 °C	(max. long term temperature +24 °C and max. short term temperature +40 °C)
	Temperature range Tb:	-40 °C to +80 °C	(max. long term temperature +50 °C and max. short term temperature +80 °C)

Hilti HIT-HY 170	Annex B1
Intended Use Specifications.	

Use conditions (Environmental conditions):

- Structures subject to dry internal conditions (zinc coated steel, stainless steel or high corrosion resistant steel).
- Structures subject to external atmospheric exposure (including industrial and marine environment) and to permanently damp internal conditions, if no particular aggressive conditions exist (stainless steel or high corrosion resistant steel).
- Structures subject to external atmospheric exposure and to permanently damp internal conditions, if other particular aggressive conditions exist (high corrosion resistant steel).

Note: Particular aggressive conditions are e.g. permanent, alternating immersion in seawater or the splash zone of seawater, chloride atmosphere of indoor swimming pools or atmosphere with extreme chemical pollution (e.g. in desulphurization plants or road tunnels where de-icing products are used).

Design:







- Anchorages are designed under the responsibility of an engineer experienced in anchorages and masonry work.
- Verifiable calculation notes and drawings are prepared taking account of the loads to be anchored. The position of the anchor is indicated on the design drawings (e. g. position of the anchor relative to supports).
- Anchorages under static or quasi-static loading are designed in accordance with: ETAG 029, Annex C, Design method A.

Installation:

- Anchor installation carried out by appropriately qualified personnel and under the supervision of the person responsible for technical matters of the site.

Hilti HIT-HY 170	Annex B2
Intended Use Specifications.	

Table B2: Overview brick types and properties











Brick type	Picture	Brick size [mm]	Compressive strength [N/mm ²]	Bulk density [kg/dm ³]	Annex
Solid clay brick EN 771-1		≥ 240x115x113	12	2,0	C3
Solid calcium silicate brick EN 771-2		≥ 240x115x113	12 / 28	2,0	C4
Hollow clay brick EN 771-1		300x240x238	12 / 20	1,4	C5
Hollow calcium silicate brick EN 771-2		248x240x238	12 / 20	1,4	C6
Hollow lightweight concrete brick EN 771-3		495x240x238	2 / 6	0,8	C7
Hollow normal weight concrete brick EN 771-3		500x200x200	4 / 10	1,0	C8

Hilti HIT-HY 170

Intended Use
Brick types and properties.

Annex B3

**Table B3: Overview fastening elements (including sizes) and corresponding brick types.
Embedment depth $h_{ef} = 80$ mm**

Brick type	Picture	HIT-V ¹⁾ 	HIT-IC 	HIT-V ¹⁾ + HIT-SC 	HIT-IC + HIT-SC 	Annex
Solid clay brick EN 771-1		M8 to M12	M8 to M12	M8 to M12	M8 to M12	C3
Solid calcium silicate brick EN 771-2		M8 to M12	M8 to M12	M8 to M12	M8 to M12	C4
Hollow clay brick EN 771-1		-	-	M8 to M12	M8 to M12	C5
Hollow calcium silicate brick EN 771-2		-	-	M8 to M12	M8 to M12	C6
Hollow lightweight concrete brick EN 771-3		-	-	M8 to M12	M8 to M12	C7
Hollow normal weight concrete brick EN 771-3		-	-	M8 to M12	M8 to M12	C8







¹⁾ Commercial standard threaded rods can also be used.

Hilti HIT-HY 170

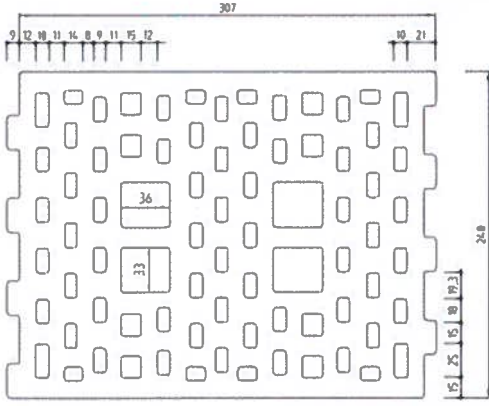
Intended Use
Fastening elements and corresponding brick types.

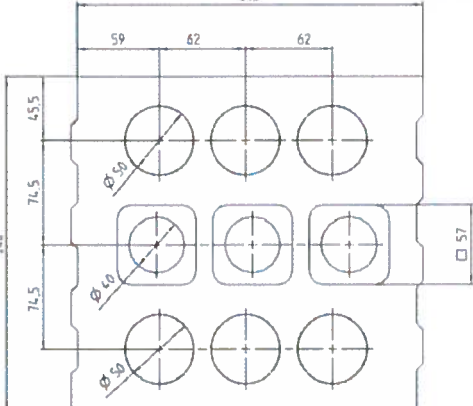
Annex B4

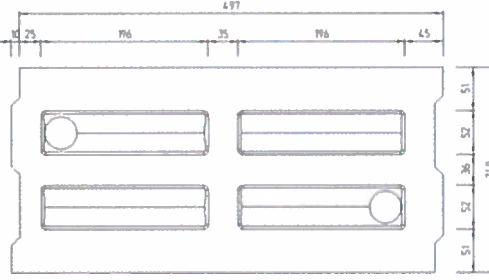
Table B4: Details of hollow bricks

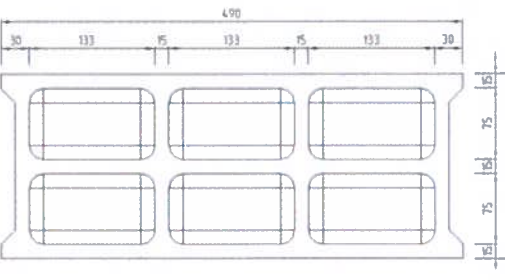
<p>Hollow clay brick EN 771-1</p> <p>Rapis Ziegel Hz 12-1,4-10DF</p>  	<p>Hollow calcium silicate brick EN 771-2</p> <p>KS Südbayern KSL-R(P) 12-1,4-8DF</p>  
<p>Hollow lightweight concrete brick EN 771-3</p> <p>Knobel Betonwerk Hbl 6-0,8-500x240x238</p>  	<p>Hollow normal weight concrete brick EN 771-3</p> <p>Parpaing creux B40</p>  

Hilti HIT-HY 170

Intended Use
Details of hollow bricks.

Annex B5

Table B5: Installation parameters of threaded rod, HIT-V-... with sieve sleeve HIT-SC in hollow brick and solid brick (Figure A1)





Threaded rod, HIT-V-...		M8	M10	M12
with HIT-SC		16x85	16x85	18x85
Nominal diameter of drill bit	d_0 [mm]	16	16	18
Drill hole depth	h_0 [mm]	95	95	95
Effective embedment depth	h_{ef} [mm]	80	80	80
Maximum diameter of clearance hole in the fixture	d_f [mm]	9	12	14
Minimum wall thickness	h_{min} [mm]	115	115	115
Brush HIT-RB	- [-]	16	16	18
Maximum torque moment for all brick types except "parpaing creux"	T_{max} [Nm]	3	4	6
Maximum torque moment for "parpaing creux"	T_{max} [Nm]	2	2	3
Number of strokes HDM	- [-]	6	6	8
Number of strokes HDE-500	- [-]	5	5	6

Table B6: Installation parameters of internally threaded sleeve HIT-IC with HIT-SC in hollow brick and solid brick (Figure A1)

HIT-IC		M8x80	M10x80	M12x80
with HIT-SC		16x85	18x85	22x85
Nominal diameter of drill bit	d_0 [mm]	16	18	22
Drill hole depth	h_0 [mm]	95	95	95
Effective embedment depth	h_{ef} [mm]	80	80	80
Thread engagement length	h_s [mm]	8...75	10...75	12...75
Maximum diameter of clearance hole in the fixture	d_f [mm]	9	12	14
Minimum wall thickness	h_{min} [mm]	115	115	115
Brush HIT-RB	- [-]	16	18	22
Maximum torque moment	T_{max} [Nm]	3	4	6
Number of strokes HDM	- [-]	6	8	10
Number of strokes HDE-500	- [-]	5	6	8

Hilti HIT-HY 170

Intended Use
Installation parameters.

Annex B6

Table B7: Installation parameters of threaded rod, HIT-V-... in solid brick (Figure A2)



Threaded rod, HIT-V-...		M8	M10	M12
Nominal diameter of drill bit	d_0 [mm]	10	12	14
Drill hole depth = Effective embedment depth	$h_0 =$ h_{ef} [mm]	80	80	80
Maximum diameter of clearance hole in the fixture	d_f [mm]	9	12	14
Minimum wall thickness	h_{min} [mm]	115	115	115
Brush HIT-RB	- [-]	10	12	14
Maximum torque moment	T_{max} [Nm]	5	8	10

Table B8: Installation parameters of internally threaded sleeve HIT-IC in solid brick (Figure A3)

HIT-IC		M8x80	M10x80	M12x80
Nominal diameter of drill bit	d_0 [mm]	14	16	18
Drill hole depth = Effective embedment depth	$h_0 =$ h_{ef} [mm]	80	80	80
Thread engagement length	h_e [mm]	8...75	10...75	12...75
Maximum diameter of clearance hole in the fixture	d_f [mm]	9	12	14
Minimum wall thickness	h_{min} [mm]	115	115	115
Brush HIT-RB	- [-]	14	16	18
Maximum torque moment	T_{max} [Nm]	5	8	10

Hilti HIT-HY 170

Intended Use
Installation parameters.

Annex B7

Table B9: Maximum working time and minimum curing time for solid bricks¹⁾

Temperature in the base material T	Maximum working time t_{work}	Minimum curing time t_{cure}
5 °C to 10 °C	8 min	2,5 h
> 10 °C to 20 °C	5 min	1,5 h
> 20 °C to 30 °C	3 min	45 min
> 30 °C to 40 °C	2 min	30 min



¹⁾ The curing time data are valid for dry base material only.
In wet base material the curing times must be doubled.

Table B10: Maximum working time and minimum curing time for hollow bricks¹⁾

Temperature in the base material T	Maximum working time t_{work}	Minimum curing time t_{cure}
-5 °C to 0 °C	10 min	12 h
> 0 °C to 5 °C	10 min	5 h
> 5 °C to 10 °C	8 min	2,5 h
> 10 °C to 20 °C	5 min	1,5 h
> 20 °C to 30 °C	3 min	45 min
> 30 °C to 40 °C	2 min	30 min

¹⁾ The curing time data are valid for dry base material only.
In wet base material the curing times must be doubled.

Table B11: Cleaning tools

<p>Manual Cleaning (MC): Hilti hand pump for blowing out drill holes</p>	
<p>Compressed air cleaning (CAC)¹⁾: air nozzle with an orifice opening of minimum 3,5 mm in diameter for blowing out drill hole</p>	
<p>Steel brush HIT-RB: according to tables B5 to B8 depending on borehole diameter for MC and CAC</p>	

¹⁾ Compressed Air Cleaning (CAC) is also allowed.

Hilti HIT-HY 170

Intended Use

Maximum working time and minimum curing time.
Cleaning tools.

Annex B8

Installation

Hole drilling

If no significant resistance is felt over the entire depth of the hole when drilling (e.g. in unfilled butt joints), the anchor should not be set at this position.

Drilling mode

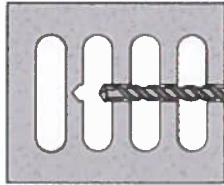

In hollow bricks (use category c): rotary mode

Drill hole to the required embedment depth with a hammer drill set in rotary mode using an appropriately sized carbide drill bit.



In solid bricks (use category b): hammer mode

Drill hole to the required embedment depth with a hammer drill set in hammer mode using an appropriately sized carbide drill bit.

Drill hole cleaning

Just before setting the anchor, the drill hole must be free of dust and debris. Inadequate hole cleaning = poor load values.

Manual Cleaning (MC) for hollow and solid bricks

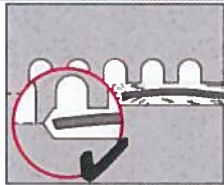

Blow out at least 2 times from the back of the drill hole with the Hilti hand pump until return air stream is free of noticeable dust.

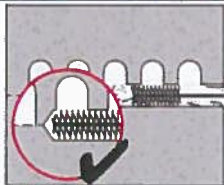

Brush 2 times with the specified steel brush (tables B5 to B8) by inserting the steel brush Hilti HIT-RB to the back of the hole in a twisting motion and removing it. The brush must produce natural resistance as it enters the drill hole (brush $\varnothing \geq$ drill hole \varnothing) - if not the brush is too small and must be replaced with the proper brush diameter.

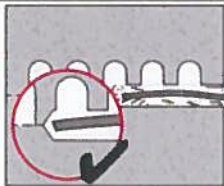

Blow out again with the Hilti hand pump at least 2 times until return air stream is free of noticeable dust.

Hilti HIT-HY 170

Intended Use
Installation instructions.

Annex B9

Injection preparation in masonry with holes or voids: installation with sieve sleeve HIT-SC



Sieve sleeve HIT-SC
Close lid.

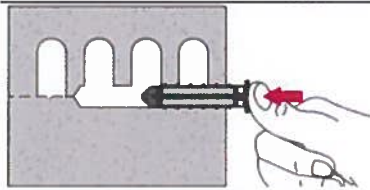

Insert sieve sleeve manually.

For all applications

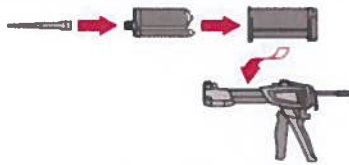

Tightly attach new Hilti mixing nozzle HIT-RE-M to foil pack manifold (snug fit). Do not modify the mixing nozzle. Observe the instruction for use of the dispenser and foil pack. Check foil pack holder for proper function. Do not use damaged foil packs / holders. Insert foil pack into foil pack holder and put holder into HIT-dispenser.



Discard initial adhesive. The foil pack opens automatically as dispensing is initiated. Depending on the size of the foil pack an initial amount of adhesive has to be discarded. Discarded quantities are:

2 strokes for 330 ml foil pack,
3 strokes for 500 ml foil pack.

Inject adhesive without forming air voids

Installation with sieve sleeve HIT-SC

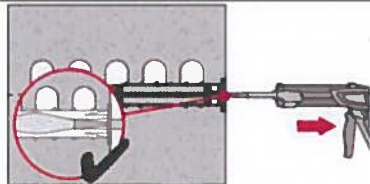

Sieve sleeve HIT-SC
Insert mixer approximately 1 cm through the lid. Inject required amount of adhesive (see tables B5 and B6). Adhesive must emerge through the lid.

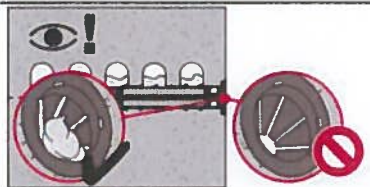

Control amount of injected mortar. Adhesive has to protrude into the lid.

After injection is completed, depressurize the dispenser by pressing the release trigger. This will prevent further adhesive discharge from the mixer.

Hilti HIT-HY 170

Intended Use
Installation instructions.

Annex B10

Solid bricks: installation without sleeve sleeve

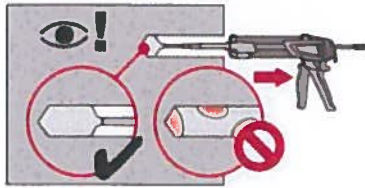

Inject the adhesive starting at the back of the hole, slowly withdrawing the mixer with each trigger pull.

Fill holes approximately 2/3 full to ensure that the annular gap between the anchor and the base material is completely filled with adhesive along the embedment length.

After injection is completed, depressurize the dispenser by pressing the release trigger. This will prevent further adhesive discharge from the mixer.

Setting the element:

Before use verify that the element is dry and free of oil and other contaminants.

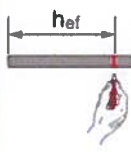
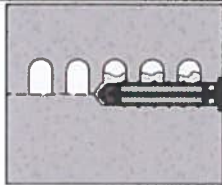

**HIT-V-... or HIT-IC in hollow and solid bricks:
Pre-setting (Figure A1 to Figure A3)**

Mark and set element to the required embedment depth until working time t_{work} has elapsed. The working time t_{work} is given in Table B9 and Table B10.

Loading the anchor

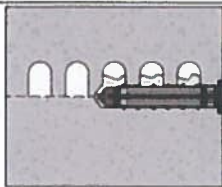

After required curing time t_{cure} (see Table B9 and Table B10) the anchor can be loaded.









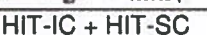
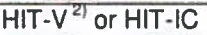

The applied installation torque shall not exceed the values T_{max} given in Table B5 to Table B8.

Hilti HIT-HY 170

Intended Use
Installation instructions.

Annex B11

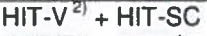
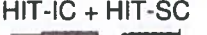
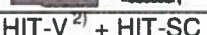
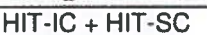
Table C1: β -factor for job-site testing under tension loading

Use categories		w/w and w/d		d/d	
Temperature range		Ta ¹⁾	Tb ¹⁾	Ta ¹⁾	Tb ¹⁾
Base material	Elements				
Solid clay brick EN 771-2	HIT-V ²⁾ or HIT-IC 	0,97	0,83	0,97	0,83
	HIT-V ²⁾ + HIT-SC 				
	HIT-IC + HIT-SC 				
Solid calcium silicate brick EN 771-2	HIT-V ²⁾ or HIT-IC 	0,96	0,84	0,97	0,84
	HIT-V ²⁾ + HIT-SC 	0,69	0,62	0,91	0,82
	HIT-IC + HIT-SC 				
Hollow clay brick EN 771-1	HIT-V ²⁾ + HIT-SC 	0,97	0,83	0,97	0,83
	HIT-IC + HIT-SC 				
Hollow calcium silicate brick EN 771-2	HIT-V ²⁾ + HIT-SC 	0,69	0,62	0,91	0,82
	HIT-IC + HIT-SC 				
Hollow light weight concrete brick EN 771-3	HIT-V ²⁾ + HIT-SC 	0,89	0,81	0,97	0,86
	HIT-IC + HIT-SC 				
Hollow normal weight concrete brick EN 771-3	HIT-V ²⁾ + HIT-SC 	0,97	0,80	0,97	0,80
	HIT-IC + HIT-SC 				

¹⁾ Temperature range Ta / Tb see Annex B1.

²⁾ Commercial standard threaded rods can also be used.

Hilti HIT-HY 170

Performances

β -factors for job-site testing under tension load.

Annex C1

Table C2: Characteristic values of steel resistance for threaded rod, HIT-V... under tension and shear loads in masonry

HIT-HY 170 with threaded rod, HIT-V...	M8	M10	M12
Steel failure tension loads			
Characteristic steel resistance $N_{Rk,s}$ [kN]	$A_s \cdot f_{uk}$		
Steel failure shear loads without lever arm			
Characteristic steel resistance $V_{Rk,s}$ [kN]	$0,5 \cdot A_s \cdot f_{uk}$		
Steel failure shear loads with lever arm			
Characteristic bending moment $M_{Rk,s}$ [kN]	$1,2 \cdot W_{el} \cdot f_{uk}$		

Table C3: Characteristic values of steel resistance for internally threaded sleeve HIT-IC under tension and shear loads in masonry

HIT-HY 170 with HIT-IC	M8	M10	M12
Steel failure tension loads			
Characteristic steel resistance $N_{Rk,s}$ [kN]	5,9	7,3	13,8
Partial safety factor $\gamma_{Ms,N}$ [-]	1,50		
Steel failure shear loads without lever arm			
Characteristic steel resistance $V_{Rk,s}$ [kN]	$0,5 \cdot A_s \cdot f_{uk}$		
Steel failure shear loads with lever arm			
Characteristic bending moment $M_{Rk,s}$ [Nm]	$1,2 \cdot W_{el} \cdot f_{uk}$		

Hilti HIT-HY 170

Performances

Characteristic resistances under tension and shear load – steel failure.

Annex C2

Brick type: Solid clay brick Mz, 2DF

Table C4: Description of brick

Brick type		[-]	Solid Mz, 2DF	
Bulk density	ρ	[kg/dm ³]	≥ 2,0	
Compressive strength	f_b	[N/mm ²]	≥ 12	
Code		[-]	EN 771 - 1	
Producer		[-]	-	
Brick dimensions		[mm]	≥ 240 x 115 x 113	
Minimum wall thickness	h_{min}	[mm]	≥ 115	





Table C5: Installation parameter for all anchor combinations (see Table B3)

Anchor type			see Table B3
Edge distance	$c_{min} = c_{cr}$	[mm]	115
Spacing	$s_{min \parallel} = s_{cr \parallel}$	[mm]	240
	$s_{min \perp} = s_{cr \perp}$	[mm]	115

Table C6: Group factor for group fastenings

Group factor	$\alpha_{0,N \parallel} \alpha_{0,V \parallel} \alpha_{0,N \perp} \alpha_{0,V \perp}$	[-]	2 at c_{cr} and s_{cr}
--------------	---	-----	----------------------------

Table C7: Characteristic tension resistance at edge distance $c \geq c_{cr}$

Use category				w/w = w/d		d/d	
Service temperature range				(Ta)	(Tb)	(Ta)	(Tb)
Anchor type and size	h_{ef} [mm]	f_b [N/mm ²]	N_{Rk} [kN]				
HIT-V ¹⁾  M8, M10, M12	80	12	3,0	2,5	3,0	2,5	
HIT-IC  M8	80	12	3,0	2,5	3,0	2,5	
			M10, M12	4,0	3,5	4,0	3,5
HIT-V ¹⁾ + HIT-SC  M8, M10, M12	80	12	4,0	3,5	4,0	3,5	
HIT-IC + HIT-SC  M8, M10, M12	80	12	4,0	3,5	4,0	3,5	

¹⁾ Commercial standard threaded rods can also be used.

Table C8: Characteristic shear resistance at edge distance $c \geq c_{cr}$

Use category				w/w = w/d		d/d	
Service temperature range				(Ta)	(Tb)	(Ta)	(Tb)
Anchor type and size	h_{ef} [mm]	f_b [N/mm ²]	V_{Rk} [kN]				
All anchors	M8, M10, M12	80	12	3,5			

Table C9: Displacements

h_{ef} [mm]	N [kN]	δ_{N0} [mm]	$\delta_{N\infty}$ [mm]	V [kN]	δ_{V0} [mm]	$\delta_{V\infty}$ [mm]
80	0,9	0,2	0,4	1,0	1,0	1,5

Hilti HIT-HY 170

Performances solid clay brick Mz, 2DF

Installation parameters and group factor.

Characteristic values of resistance under tension and shear loads. Displacements.

Annex C3

Brick type: Solid calcium silicate brick KS, 2DF

Table C10: Description of brick

Brick type		[-]	Solid KS, 2DF	
Bulk density	ρ	[kg/dm ³]	≥ 2,0	
Compressive strength	f_b	[N/mm ²]	≥ 12 or ≥ 28	
Code		[-]	EN 771 - 2	
Producer		[-]	-	
Brick dimensions		[mm]	≥ 240 x 115 x 113	
Minimum wall thickness	h_{min}	[mm]	≥ 115	





Table C11: Installation parameter for all anchor combinations (see Table B3)

Anchor type		see Table B3
Edge distance	$c_{min} = c_{cr}$ [mm]	115
Spacing	$s_{min \parallel} = s_{cr \parallel}$ [mm]	240
	$s_{min \perp} = s_{cr \perp}$ [mm]	115

Table C12: Group factor for group fastenings

Group factor	$\alpha_{q,N \parallel} \alpha_{q,V \parallel} \alpha_{q,N \perp} \alpha_{q,V \perp}$ [-]	2 at c_{cr} and s_{cr}
--------------	---	----------------------------

Table C13: Characteristic tension resistance at edge distance $c \geq c_{cr}$

Use category			w/w = w/d		d/d	
Service temperature range			(Ta)	(Tb)	(Ta)	(Tb)
Anchor type and size	h_{ef} [mm]	f_b [N/mm ²]	N_{Rk} [kN]			
HIT-V ¹⁾  M8, M10, M12	80	12	5,5	5,0	6,0	5,0
HIT-IC 		28	8,5	7,5	8,5	7,5
HIT-V ¹⁾ + HIT-SC  M8, M10, M12	80	12	4,0	3,5	5,5	5,0
HIT-IC + HIT-SC 		28	6,0	5,5	8,0	7,5

¹⁾ Commercial standard threaded rods can also be used.

Table C14: Characteristic shear resistance at edge distance $c \geq c_{cr}$

Use category			w/w = w/d		d/d	
Service temperature range			(Ta)	(Tb)	(Ta)	(Tb)
Anchor type and size	h_{ef} [mm]	f_b [N/mm ²]	V_{Rk} [kN]			
All anchors M8, M10, M12	80	12	4,0			
		28	6,0			

Table C15: Displacements

h_{ef} [mm]	N [kN]	δ_{N0} [mm]	$\delta_{N\infty}$ [mm]	V [kN]	δ_{V0} [mm]	$\delta_{V\infty}$ [mm]
80mm	2,3	0,2	0,4	1,5	1,2	1,8

Hilti HIT-HY 170

Performances solid silica brick KS, 2DF

Installation parameters and group factor.

Characteristic values of resistance under tension and shear loads. Displacements.

Annex C4

Brick type: Hollow clay brick Hz, 10DF

Table C16: Description of brick

Brick type			Hz 12-1,4-10 DF	 <p>Drawing of the brick see Table B4</p>
Bulk density	ρ	[kg/dm ³]	≥ 1,4	
Compressive strength	f_b	[N/mm ²]	≥ 12 or ≥ 20	
Code			EN 771 - 1	
Producer			Rapis (D)	
Brick dimensions		[mm]	300 x 240 x 238	
Minimum wall thickness	h_{min}	[mm]	≥ 240	





Table C17: Installation parameter for all anchor combinations (see Table B3)

Anchor type		see Table B3
Edge distance	$c_{min} = c_{cr}$ [mm]	150
Spacing	$s_{min \parallel} = s_{cr \parallel}$ [mm]	300
	$s_{min \perp} = s_{cr \perp}$ [mm]	240

Table C18: Group factor for group fastenings





Group factor	$\alpha_{g,N \parallel} \alpha_{g,V \parallel} \alpha_{g,N \perp} \alpha_{g,V \perp}$ [-]	2 at c_{cr} and s_{cr}
--------------	---	----------------------------

Table C19: Characteristic tension resistance at edge distance $c \geq c_{cr}$

Use category			w/w = w/d		d/d	
Service temperature range			(Ta)	(Tb)	(Ta)	(Tb)
Anchor type and size	h_{ef} [mm]	f_b [N/mm ²]	N_{Rk} [kN]			
HIT-V ¹⁾ + HIT-SC   M8, M10, M12	80	12	3,0	2,5	3,0	2,5
HIT-IC + HIT-SC   M8, M10, M12		20	3,5	3,0	3,5	3,0

¹⁾ Commercial standard threaded rods can also be used.

Table C20: Characteristic shear resistance at edge distance $c \geq c_{cr}$

Use category			w/w = w/d		d/d	
Service temperature range			(Ta)	(Tb)	(Ta)	(Tb)
Anchor type and size	h_{ef} [mm]	f_b [N/mm ²]	V_{Rk} [kN]			
HIT-V ¹⁾ + HIT-SC   M8, M10, M12	80	12	2,0			
HIT-IC + HIT-SC   M8, M10, M12		20	3,0			

¹⁾ Commercial standard threaded rods can also be used.

Table C21: Displacements

h_{ef} [mm]	N [kN]	δ_{N0} [mm]	$\delta_{N_{90}}$ [mm]	V [kN]	δ_{V0} [mm]	$\delta_{V_{90}}$ [mm]
80	0,9	0,2	0,3	0,9	1,0	1,5

Hilti HIT-HY 170

Performances hollow clay brick Hz, 10DF

Installation parameters and group factor.

Characteristic values of resistance under tension and shear loads. Displacements.

Annex C5

Brick type: Hollow calcium silicate brick KSL, 8DF

Table C22: Description of brick

Brick type	[-]	KSL-12-1,4-8 DF	 <p>Drawing of the brick see Table B4</p>
Bulk density	ρ [kg/dm ³]	≥ 1,4	
Compressive strength	f_b [N/mm ²]	≥ 12 or ≥ 20	
Code	[-]	EN 771 – 2	
Producer	[-]	KS Südbayern (D)	
Brick dimensions	[mm]	248 x 240 x 238	
Minimum wall thickness	h_{min} [mm]	≥ 240	

Table C23: Installation parameter for all anchor combinations (see Table B3)

Anchor type	see Table B3	
Edge distance	$c_{min} = c_{cr}$ [mm]	125
Spacing	$s_{min \parallel} = s_{cr \parallel}$ [mm]	248
	$s_{min \perp} = s_{cr \perp}$ [mm]	240

Table C24: Group factor for group fastenings

Group factor	$\alpha_{g,N \parallel} \alpha_{g,V \parallel} \alpha_{g,N \perp} \alpha_{g,V \perp}$ [-]	2 at c_{cr} and s_{cr}
--------------	---	----------------------------

Table C25: Characteristic tension resistance at edge distance $c \geq c_{cr}$

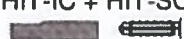
Use category			w/w = w/d		d/d	
Service temperature range			(Ta)	(Tb)	(Ta)	(Tb)
Anchor type and size	h_{ef} [mm]	f_b [N/mm ²]	N_{Rk} [kN]			
HIT-V ¹⁾ + HIT-SC  M8, M10, M12	80	12	3,0	2,5	3,5	3,0
HIT-IC + HIT-SC  M8, M10, M12		20	4,0	3,5	5,0	4,5

¹⁾ Commercial standard threaded rods can also be used.

Table C26: Characteristic shear resistance at edge distance $c \geq c_{cr}$

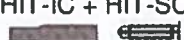
Use category			w/w = w/d		d/d	
Service temperature range			(Ta)	(Tb)	(Ta)	(Tb)
Anchor type and size	h_{ef} [mm]	f_b [N/mm ²]	V_{Rk} [kN]			
HIT-V ¹⁾ + HIT-SC  M8, M10, M12	80	12	8,5			
HIT-IC + HIT-SC  M8, M10, M12		20	12,0			

¹⁾ Commercial standard threaded rods can also be used.

Table C27: Displacements

h_{ef} [mm]	N [kN]	δ_{N0} [mm]	$\delta_{N\infty}$ [mm]	V [kN]	δ_{V0} [mm]	$\delta_{V\infty}$ [mm]
80	1,8	0,2	0,3	3,4	2,5	3,8

Hilti HIT-HY 170

Performances hollow silica brick KSL, 8DF

Installation parameters and group factor.

Characteristic values of resistance under tension and shear loads. Displacements.

Annex C6

Brick type: Hollow lightweight concrete brick Hbl, 16DF

Table C28: Description of brick

Brick type	[-]	Hbl-4-0,7	 <p>Drawing of the brick see Table B4</p>
Bulk density	ρ [kg/dm ³]	≥ 0,8	
Compressive strength	f_b [N/mm ²]	≥ 2 or ≥ 6	
Code	[-]	EN 771-3	
Producer	[-]	Knobel (D)	
Brick dimensions	[mm]	495 x 240 x 238	
Minimum wall thickness	h_{min} [mm]	≥ 240	





Table C29: Installation parameter for all anchor combinations (see Table B3)

Anchor type		see Table B3
Edge distance	$c_{min} = c_{cr}$ [mm]	250
Spacing	$s_{min \parallel} = s_{cr \parallel}$ [mm]	240
	$s_{min \perp} = s_{cr \perp}$ [mm]	240

Table C30: Group factor for group fastenings





Group factor	$\alpha_{g,N \parallel} \alpha_{g,V \parallel} \alpha_{g,N \perp} \alpha_{g,V \perp}$ [-]	2 at c_{cr} and s_{cr}
--------------	---	----------------------------

Table C31: Characteristic tension resistance at edge distance $c \geq c_{cr}$

Use category			w/w = w/d		d/d	
Service temperature range			(Ta)	(Tb)	(Ta)	(Tb)
Anchor type and size	h_{ef} [mm]	f_b [N/mm ²]	N_{Rk} [kN]			
HIT-V ¹⁾ + HIT-SC   M8, M10, M12	80	2	1,2	0,9	1,5	1,2
HIT-IC + HIT-SC  		6	2,0	1,5	2,5	2,0

¹⁾ Commercial standard threaded rods can also be used.

Table C32: Characteristic shear resistance at edge distance $c \geq c_{cr}$

Use category			w/w = w/d		d/d	
Service temperature range			(Ta)	(Tb)	(Ta)	(Tb)
Anchor type and size	h_{ef} [mm]	f_b [N/mm ²]	V_{Rk} [kN]			
HIT-V ¹⁾ + HIT-SC   M8, M10, M12	80	2	2,5			
HIT-IC + HIT-SC  		6	4,0			

¹⁾ Commercial standard threaded rods can also be used.

Table C33: Displacements

h_{ef} [mm]	N [kN]	δ_{N0} [mm]	$\delta_{N\infty}$ [mm]	V [kN]	δ_{V0} [mm]	$\delta_{V\infty}$ [mm]
80	2,4	0,2	0,4	3,4	1,3	1,9

Hilti HIT-HY 170

Performances hollow lightweight concrete brick Hbl 16DF
Installation parameters and group factor.
Characteristic values of resistance under tension and shear loads. Displacements.

Annex C7

Brick type: Hollow normal weight concrete brick - parpaing creux

Table C34: Description of brick

Brick type			B40	 <p>Drawing of the brick see Table B4</p>
Bulk density	ρ	[kg/dm ³]	≥ 1,0	
Compressive strength	f_b	[N/mm ²]	≥ 4 or ≥ 10	
Code			EN 771-3	
Producer			Fabemi (F)	
Brick dimensions		[mm]	500 x 200 x 200	
Minimum wall thickness	h_{min}	[mm]	≥ 200	





Table C35: Installation parameter for all anchor combinations (see Table B3)

Anchor type		see Table B3
Edge distance	$c_{min} = c_{cr}$ [mm]	200
Spacing	$s_{min \parallel} = s_{cr \parallel}$ [mm]	200
	$s_{min \perp} = s_{cr \perp}$ [mm]	200

Table C36: Group factor for group fastenings





Group factor	$\alpha_{g,N \parallel} \alpha_{g,V \parallel} \alpha_{g,N \perp} \alpha_{g,V \perp}$ [-]	2 at c_{cr} and s_{cr}
--------------	---	----------------------------

Table C37: Characteristic tension resistance at edge distance $c \geq c_{cr}$

Use category			w/w = w/d		d/d	
Service temperature range			(Ta)	(Tb)	(Ta)	(Tb)
Anchor type and size	h_{ef} [mm]	f_b [N/mm ²]	N_{Rk} [kN]			
HIT-V ¹⁾ + HIT-SC   M8, M10, M12	80	4	0,9	0,9	0,9	0,9
HIT-IC + HIT-SC  		10	1,2	1,2	1,5	1,5

¹⁾ Commercial standard threaded rods can also be used.

Table C38: Characteristic shear resistance at edge distance $c \geq c_{cr}$

Use category			w/w = w/d		d/d	
Service temperature range			(Ta)	(Tb)	(Ta)	(Tb)
Anchor type and size	h_{ef} [mm]	f_b [N/mm ²]	V_{Rk} [kN]			
HIT-V ¹⁾ + HIT-SC   M8, M10, M12	80	4	2,5			
HIT-IC + HIT-SC  		10	4,0			

¹⁾ Commercial standard threaded rods can also be used.

Table C39: Displacements

h_{ef} [mm]	N [kN]	δ_{N0} [mm]	$\delta_{N_{10}}$ [mm]	V [kN]	δ_{V0} [mm]	$\delta_{V_{10}}$ [mm]
80	1,0	0,6	1,2	2,3	0,6	0,9

Hilti HIT-HY 170

Performances hollow normal weight concrete brick - parpaing creux
Installation parameters and group factor.
Characteristic values of resistance under tension and shear loads. Displacements.

Annex C8

Zulassungsstelle für Bauprodukte und Bauarten

Bautechnisches Prüfamnt

Eine vom Bund und den Ländern
gemeinsam getragene Anstalt des öffentlichen Rechts



Europäische Technische Bewertung

ETA-15/0197
vom 9. Dezember 2015

Allgemeiner Teil

Technische Bewertungsstelle, die die Europäische Technische Bewertung ausstellt

Deutsches Institut für Bautechnik

Handelsname des Bauprodukts

Injektionssystem Hilti HIT-HY 170

Produktfamilie,
zu der das Bauprodukt gehört

Injektionssystem zur Verankerung im Mauerwerk

Hersteller

Hilti AG
Feldkircherstraße 100
9494 Schaan
FÜRSTENTUM LIECHTENSTEIN

Herstellungsbetrieb

Hilti Werke

Diese Europäische Technische Bewertung enthält

26 Seiten, davon 3 Anhänge, die fester Bestandteil dieser Bewertung sind.

Diese Europäische Technische Bewertung wird gemäß der Verordnung (EU) Nr. 305/2011 auf der Grundlage von

Leitlinie für die europäisch technische Zulassung für "Injektionsdübel aus Metall zur Verankerung im Mauerwerk" ETAG 029, April 2013, verwendet als Europäisches Bewertungsdokument (EAD) gemäß Artikel 66 Absatz 3 der Verordnung (EU) Nr. 305/2011, ausgestellt.

Diese Fassung ersetzt

ETA-15/0197 vom 28. April 2015

Die Europäische Technische Bewertung wird von der Technischen Bewertungsstelle in ihrer Amtssprache ausgestellt. Übersetzungen dieser Europäischen Technischen Bewertung in andere Sprachen müssen dem Original vollständig entsprechen und müssen als solche gekennzeichnet sein.

Diese Europäische Technische Bewertung darf, auch bei elektronischer Übermittlung, nur vollständig und ungekürzt wiedergegeben werden. Nur mit schriftlicher Zustimmung der ausstellenden Technischen Bewertungsstelle kann eine teilweise Wiedergabe erfolgen. Jede teilweise Wiedergabe ist als solche zu kennzeichnen.

Die ausstellende Technische Bewertungsstelle kann diese Europäische Technische Bewertung widerrufen, insbesondere nach Unterrichtung durch die Kommission gemäß Artikel 25 Absatz 3 der Verordnung (EU) Nr. 305/2011.

Besonderer Teil

1 Technische Beschreibung des Produkts

Das Injektionssystem Hilti HIT-HY 170 für Mauerwerk ist ein Verbunddübel (Injektionstyp), der aus einem Foliengebilde mit Injektionsmörtel Hilti HIT-HY 170, einer Siebhülse und einer Gewindestange mit Sechskantmutter und Unterlegscheibe in den Größen M8 bis M12 oder einer Innengewindehülse in den Größen M8 bis M12 besteht. Die Stahlteile bestehen aus verzinktem Stahl, nichtrostendem Stahl oder hochkorrosionsbeständigem Stahl.

Die Ankerstange wird in ein mit Injektionsmörtel gefülltes Bohrloch gesetzt und durch den Verbund und/oder Formschluss zwischen Stahlteil, Injektionsmörtel und Mauerwerk verankert.

Die Produktbeschreibung ist in Anhang A angegeben.

2 Spezifizierung des Verwendungszwecks gemäß dem anwendbaren Europäischen Bewertungsdokument

Von den Leistungen in Abschnitt 3 kann nur ausgegangen werden, wenn der Dübel entsprechend den Angaben und Bedingungen nach Anhang B verwendet wird.

Die Prüf- und Bewertungsmethoden, die dieser Europäischen Technischen Bewertung zu Grunde liegen, führen zur Annahme einer Nutzungsdauer des Dübels von mindestens 50 Jahren. Die Angabe der Nutzungsdauer kann nicht als Garantie des Herstellers verstanden werden, sondern ist lediglich ein Hilfsmittel zur Auswahl des richtigen Produkts in Bezug auf die angenommene wirtschaftlich angemessene Nutzungsdauer des Bauwerks.

3 Leistung des Produkts und Angaben der Methoden ihrer Bewertung

3.1 Mechanische Festigkeit und Standsicherheit (BWR 1)

Wesentliches Merkmal	Leistung
Charakteristische Tragfähigkeit der Stahlelemente	Siehe Anhang C2
Charakteristische Tragfähigkeit der Dübel im Mauerwerk	Siehe Anhang C3 – C8
Verformungen unter Querlast und Zuglast	Siehe Anhang C3 – C8
Reduktionsfaktor für Baustellenversuche (β -Faktor)	Siehe Anhang C1
Rand- und Achsabstände	Siehe Anhang C3 – C8
Gruppenfaktor für Gruppenbefestigungen	Siehe Anhang C3 – C8

3.2 Brandschutz (BWR 2)

Wesentliches Merkmal	Leistung
Brandverhalten	Klasse A1
Feuerwiderstand	Leistung nicht bewertet

3.3 Hygiene, Gesundheit und Umweltschutz (BWR 3)

Bezüglich gefährlicher Stoffe können die Produkte im Geltungsbereich dieser Europäischen Technischen Bewertung weiteren Anforderungen unterliegen (z. B. umgesetzte europäische Gesetzgebung und nationale Rechts- und Verwaltungsvorschriften). Um die Bestimmungen der Verordnung (EU) Nr. 305/2011 zu erfüllen, müssen gegebenenfalls diese Anforderungen ebenfalls eingehalten werden.

3.4 Sicherheit bei der Nutzung (BWR 4)

Die wesentlichen Merkmale bezüglich Sicherheit bei der Nutzung sind unter der Grundanforderung Mechanische Festigkeit und Standsicherheit erfasst.

4 Angewandtes System zur Bewertung und Überprüfung der Leistungsbeständigkeit mit der Angabe der Rechtsgrundlage

Gemäß der Leitlinie für die europäische technische Zulassung ETAG 029, April 2013 verwendet als Europäisches Bewertungsdokument (EAD) gemäß Artikel 66 Absatz 3 der Verordnung (EU) Nr. 305/2011 gilt folgende Rechtsgrundlage: [97/177/EG].

Folgendes System ist anzuwenden: 1

5 Für die Durchführung des Systems zur Bewertung und Überprüfung der Leistungsbeständigkeit erforderliche technische Einzelheiten gemäß anwendbarem Europäischen Bewertungsdokument

Technische Einzelheiten, die für die Durchführung des Systems zur Bewertung und Überprüfung der Leistungsbeständigkeit notwendig sind, sind Bestandteil des Prüfplans, der beim Deutschen Institut für Bautechnik hinterlegt ist.

Ausgestellt in Berlin am 9. Dezember 2015 vom Deutschen Institut für Bautechnik

Uwe Bender
Abteilungsleiter



Einbauzustand

Bild A1: Lochstein und Vollstein mit Gewindestange, HIT-V... und Siebhülse HIT-SC (siehe Tabelle B5) oder mit Innengewindehülse HIT-IC und Siebhülse HIT-SC (siehe Tabelle B6)



Bild A2: Vollstein mit Gewindestange, HIT-V... (siehe Tabelle B7)



Bild A3: Vollstein mit Innengewindehülse HIT-IC (siehe Tabelle B8)

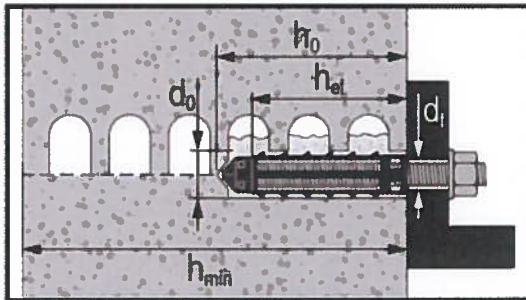

Hilti HIT-HY 170

Produktbeschreibung
Einbauzustand.

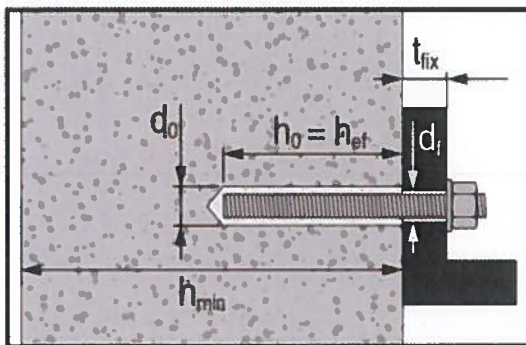
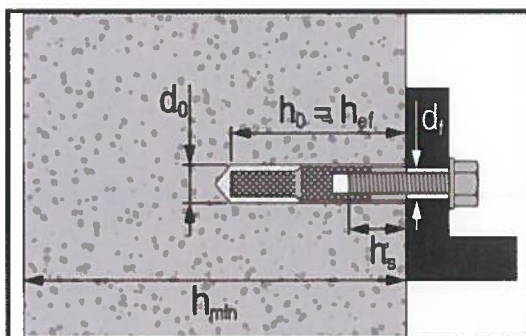
Anhang A1

Produktbeschreibung: Injektionsmörtel und Stahlelemente

**Injektionsmörtel Hilti HIT-HY 170: Hybridsystem mit Zuschlag
330 ml und 500 ml**

Kennzeichnung
HILTI HIT
Chargennummer und
Produktionslinie
Verfallsdatum mm/yyyy



Produktname: "Hilti HIT-HY 170"

Statkmischer Hilti HIT-RE-M



Gewindestange, HIT-V-...: M8 bis M12



Handelsübliche Gewindestangen mit:

- Werkstoff und mechanische Eigenschaften gemäß Tabelle A1.
- Abnahmeprüfzeugnis 3.1 gemäß EN 10204:2004. Die Dokumente sind aufzubewahren.
- Markierung der Setztiefe.

Innengewindehülse HIT-IC M8 bis M12



Kennzeichnung:
z.B. HIT-IC M8x80

Siebhülse HIT-SC 16 bis 22

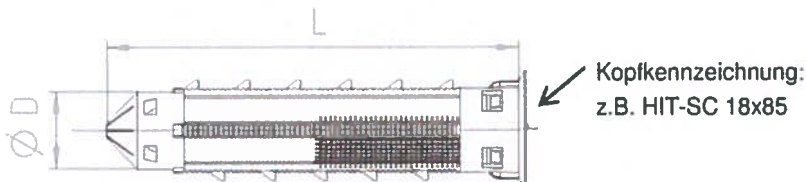

Kopfkennzeichnung:
z.B. HIT-SC 18x85

Hilti HIT-HY 170

Produktbeschreibung
Injektionsmörtel / Statkmischer / Stahlelemente / Siebhülsen.

Anhang A2

Tabelle A1: Werkstoffe

Bezeichnung	Werkstoff
Stahlteile aus verzinktem Stahl	
Gewindestange HIT-V-5.8(F)	Festigkeitsklasse 5.8, $f_{uk} = 500 \text{ N/mm}^2$, $f_{yk} = 400 \text{ N/mm}^2$. Bruchdehnung ($l_0 = 5d$) > 8% duktil. Galvanisch verzinkt $\geq 5 \mu\text{m}$, (F) Feuerverzinkt $\geq 45 \mu\text{m}$.
Gewindestange HIT-V-8.8(F)	Festigkeitsklasse 8.8, $f_{uk} = 800 \text{ N/mm}^2$, $f_{yk} = 640 \text{ N/mm}^2$. Bruchdehnung ($l_0 = 5d$) > 8% duktil. Galvanisch verzinkt $\geq 5 \mu\text{m}$, (F) Feuerverzinkt $\geq 45 \mu\text{m}$.
Innengewindehülse HIT-IC	$f_{uk} = 490 \text{ N/mm}^2$; $f_{yk} = 390 \text{ N/mm}^2$. Bruchdehnung ($l_0 = 5d$) > 8% duktil. Galvanisch verzinkt $\geq 5 \mu\text{m}$.
Scheibe	Galvanisch verzinkt $\geq 5 \mu\text{m}$. Feuerverzinkt $\geq 45 \mu\text{m}$.
Mutter	Festigkeit der Sechskantmutter abgestimmt auf Festigkeit der Gewindestange. Galvanisch verzinkt $\geq 5 \mu\text{m}$, (F) Feuerverzinkt $\geq 45 \mu\text{m}$.
Stahlteile aus nichtrostendem Stahl	
Gewindestange HIT-V-R	Festigkeitsklasse 70, $f_{uk} = 700 \text{ N/mm}^2$, $f_{yk} = 450 \text{ N/mm}^2$. Bruchdehnung ($l_0 = 5d$) > 8% duktil. Werkstoff 1.4401, 1.4404, 1.4578, 1.4571, 1.4439, 1.4362 EN 10088-1:2014.
Scheibe	Werkstoff 1.4401, 1.4404, 1.4578, 1.4571, 1.4439, 1.4362 EN 10088-1:2014.
Mutter	Festigkeit der Sechskantmutter abgestimmt auf Festigkeit der Gewindestange. Werkstoff 1.4401, 1.4404, 1.4578, 1.4571, 1.4439, 1.4362 EN 10088-1:2014.
Stahlteile aus hochkorrosionsbeständigem Stahl	
Gewindestange HIT-V-HCR	$f_{uk} = 800 \text{ N/mm}^2$, $f_{yk} = 640 \text{ N/mm}^2$. Bruchdehnung ($l_0 = 5d$) > 8% duktil. Werkstoff 1.4529, 1.4565 EN 10088-1:2014.
Scheibe	Werkstoff 1.4529, 1.4565 EN 10088-1:2014.
Mutter	Festigkeit der Sechskantmutter abgestimmt auf Festigkeit der Gewindestange. Werkstoff 1.4529, 1.4565 EN 10088-1:2014.
Plastikteile	
Siebhülse HIT-SC	Rahmen: FPP 20T. Netz: PA6.6 N500/200.

Hilti HIT-HY 170

Produktbeschreibung
Werkstoffe.

Anhang A3

Angaben zum Verwendungszweck

Verankerungsgrund:

- Vollsteinmauerwerk (Nutzungskategorie b), entsprechend Anlage B3.
Bemerkung: Die charakteristischen Widerstände gelten ebenfalls für größere Steinabmessungen und höhere Steindruckfestigkeiten.
- Lochsteinmauerwerk (Nutzungskategorie c), entsprechend Anlage B3 und B5.
- Festigkeitsklasse des Mauermörtel: mindestens M2,5 entsprechend EN 998-2: 2010.
- Für Mauerwerk aus anderen Vollsteinen oder Lochsteinen darf der charakteristische Widerstand mittels Baustellenversuchen ermittelt werden. Dies geschieht gemäß ETAG 029, Anhang B, unter Berücksichtigung des im Anhang C1, Tabelle C1 genannten β -Faktors.

Tabelle B1: Übersicht der Nutzungskategorien

Befestigungen unter:		HIT-HY 170 mit Gewindestange, HIT-V... oder HIT-IC	
		in Vollstein	in Lochstein
Bohren 		Hammerbohren	Drehbohren
Statische und quasi statische Belastung		Anhang : C2 (Stahl), C3, C4	Anhang : C2 (Stahl), C5, C6, C7, C8
Nutzungskategorie: trockenes oder feuchtes Mauerwerk		Kategorie d/d – Montage und Verwendung in Bauteilen unter den Bedingungen trockener Innenräume. Kategorie w/d – Montage unter trockenen oder feuchten Bedingungen und Verwendung unter den Bedingungen trockener Innenräume (ausgenommen Kalksandsteine). Kategorie w/w - Montage und Verwendung in Bauteilen unter trockenen oder feuchten Bedingungen (ausgenommen Kalksandsteine).	
Montagerichtung		horizontal	
Nutzungskategorie		b (Mauerwerk aus Vollstein)	c (Mauerwerk aus Lochstein)
Temperatur im Verankerungsgrund beim Einbau		+5 °C bis +40 °C (Tabelle B9)	-5 °C bis +40 °C (Tabelle B10)
Gebrauchstempertur	Temperaturbereich Ta:	-40 °C bis +40 °C	(max. Langzeittemperatur +24 °C und max. Kurzzeittemperatur +40 °C)
	Temperaturbereich Tb:	-40 °C bis +80 °C	(max. Langzeittemperatur +50 °C und max. Kurzzeittemperatur +80 °C)

Hilti HIT-HY 170

Verwendungszweck
Spezifikationen.

Anhang B1

Anwendungsbedingungen (Umweltbedingungen):

- In Bauteilen unter den Bedingungen trockener Innenräume (verzinkter Stahl, nichtrostender Stahl oder hochkorrosionsbeständiger Stahl).
- Bauteile im Freien (einschließlich Industrielatmosphäre und Meeresnähe) und in Feuchträumen, wenn keine besonders aggressiven Bedingungen vorliegen (nichtrostender Stahl oder hochkorrosionsbeständiger Stahl).
- Bauteile im Freien und in Feuchträumen, wenn besonders aggressive Bedingungen vorliegen (hochkorrosionsbeständiger Stahl).
Anmerkung: Aggressive Bedingungen sind z. B. ständiges, abwechselndes Eintauchen in Meerwasser oder der Bereich der Spritzzone von Meerwasser, chlorhaltige Atmosphäre in Schwimmbadhallen oder Atmosphäre mit extremer chemischer Verschmutzung (z. B. bei Rauchgas-Entschwefelungsanlagen oder Straßentunneln, in denen Enteisungsmittel verwendet werden).

Bemessung:

- Die Befestigungen müssen unter der Verantwortung eines auf dem Gebiet der Verankerungen und des Mauerwerksbaus erfahrenen Ingenieurs bemessen werden.
- Unter Berücksichtigung der zu verankernden Lasten sind prüfbare Berechnungen und Konstruktionszeichnungen anzufertigen. Auf den Konstruktionszeichnungen ist die Lage des Dübels (z. B. Lage des Dübels zu den Auflagern) anzugeben.
- Die Bemessung der Verankerungen erfolgt in Übereinstimmung mit: ETAG 029, Anhang C, Bemessungsverfahren A.

Einbau:

- Der Einbau erfolgt durch entsprechend geschultes Personal unter der Aufsicht des Bauleiters.

Hilti HIT-HY 170

Verwendungszweck
Spezifikationen.

Anhang B2

Tabelle B2: Übersicht der Mauersteine und Eigenschaften











Art des Mauersteins	Foto	Steinabmessungen [mm]	Druckfestigkeit [N/mm ²]	Rohdichte [kg/dm ³]	Anhang
Vollziegel EN 771-1		≥ 240x115x113	12	2,0	C3
Kalksandvollstein EN 771-2		≥ 240x115x113	12 / 28	2,0	C4
Lochziegel EN 771-1		300x240x238	12 / 20	1,4	C5
Kalksandlochstein EN 771-2		248x240x238	12 / 20	1,4	C6
Leichtbeton Hohlblockstein EN 771-3		495x240x238	2 / 6	0,8	C7
Normalbeton Lochstein EN 771-3		500x200x200	4 / 10	1,0	C8

Hilti HIT-HY 170

Verwendungszweck
Steintypen und Eigenschaften.

Anhang B3







**Tabelle B3: Übersicht Befestigungselemente (inkl. Größen) und zugehörige Mauerseine.
Verankerungstiefe $h_{ef} = 80$ mm**

Art des Mauersteins	Foto	HIT-V ¹⁾ 	HIT-IC 	HIT-V ¹⁾ + HIT-SC 	HIT-IC + HIT-SC 	Anhang
Vollziegel EN 771-1		M8 bis M12	M8 bis M12	M8 bis M12	M8 bis M12	C3
Kalksandvollstein EN 771-2		M8 bis M12	M8 bis M12	M8 bis M12	M8 bis M12	C4
Lochziegel EN 771-1		-	-	M8 bis M12	M8 bis M12	C5
Kalksandlochstein EN 771-2		-	-	M8 bis M12	M8 bis M12	C6
Leichtbeton Hohlblockstein EN 771-3		-	-	M8 bis M12	M8 bis M12	C7
Normalbeton Lochstein EN 771-3		-	-	M8 bis M12	M8 bis M12	C8

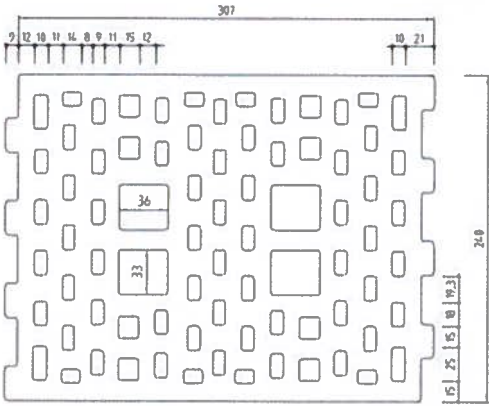
¹⁾ Handelsübliche Gewindestangen können ebenfalls verwendet werden.

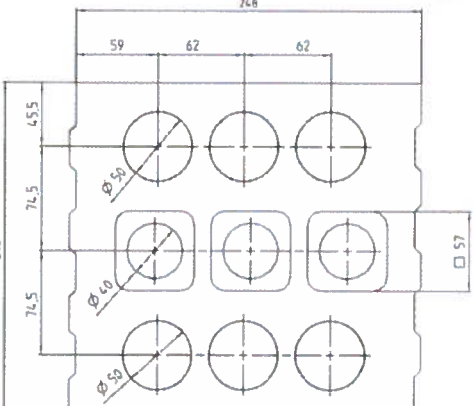
Hilti HIT-HY 170	Anhang B4
Verwendungszweck Befestigungselemente und entsprechende Steintypen.	

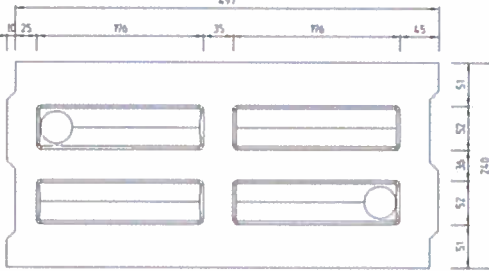
Tabelle B4: Details der Lochsteine

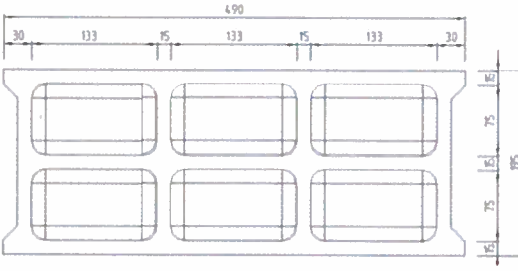
<p>Hochlochziegel EN 771-1</p> <p>Rapis Ziegel Hz 12-1,4-10DF</p>  	<p>Kalksandlochstein EN 771-2</p> <p>KS Südbayern KSL-R(P) 12-1,4-8DF</p>  
<p>Leichtbeton Hohlblockstein EN 771-3</p> <p>Knobel Betonwerk Hbl 6-0,8-500x240x238</p>  	<p>Leichtbeton Hohlblockstein EN 771-3</p> <p>Parpaing creux B40</p>  

<p>Hilti HIT-HY 170</p>	<p>Anhang B5</p>
<p>Verwendungszweck Details der Lochsteine.</p>	

Tabelle B5: Montagekennwerte Gewindestange, HIT-V-... mit Siebhülse HIT-SC für Lochstein und Vollstein (Bild A1)





Gewindestange, HIT-V-...		M8	M10	M12
mit HIT-SC		16x85	16x85	18x85
Bohrerinnendurchmesser	d_0 [mm]	16	16	18
Bohrlochtiefe	h_0 [mm]	95	95	95
Effektive Verankerungstiefe	h_{ef} [mm]	80	80	80
Maximaler Durchmesser des Durchgangslochs im Anbauteil	d_f [mm]	9	12	14
Minimale Wanddicke	h_{min} [mm]	115	115	115
Bürste HIT-RB	- [-]	16	16	18
Maximales Anzugsdrehmoment für alle Steine ausser „Parpaing creux“	T_{max} [Nm]	3	4	6
Maximales Anzugsdrehmoment für „Parpaing creux“	T_{max} [Nm]	2	2	3
Anzahl Hübe HDM	- [-]	6	6	8
Anzahl Hübe HDE 500	- [-]	5	5	6

Tabelle B6: Montagekennwerte Innengewindehülse HIT-IC mit Siebhülse HIT-SC für Lochstein und Vollstein (Bild A1)

HIT-IC		M8x80	M10x80	M12x80
mit HIT-SC		16x85	18x85	22x85
Bohrerinnendurchmesser	d_0 [mm]	16	18	22
Bohrlochtiefe	h_0 [mm]	95	95	95
Effektive Verankerungstiefe	h_{ef} [mm]	80	80	80
Einschraubtiefe	h_s [mm]	8...75	10...75	12...75
Maximaler Durchmesser des Durchgangslochs im Anbauteil	d_f [mm]	9	12	14
Minimale Wanddicke	h_{min} [mm]	115	115	115
Bürste HIT-RB	- [-]	16	18	22
Maximales Anzugsdrehmoment	T_{max} [Nm]	3	4	6
Anzahl Hübe HDM	- [-]	6	8	10
Anzahl Hübe HDE 500	- [-]	5	6	8

Hilti HIT-HY 170

Verwendungszweck
Montagekennwerte.

Anhang B6

Tabelle B7: Montagekennwerte Gewindestange, HIT-V-... in Vollstein (Bild A2)



Gewindestange, HIT-V-...		M8	M10	M12
Bohrernennendurchmesser	d_0 [mm]	10	12	14
Bohrlochtiefe = Effektive Verankerungstiefe	$h_0 =$ h_{ef} [mm]	80	80	80
Maximaler Durchmesser des Durchgangslochs im Anbauteil	d_f [mm]	9	12	14
Minimale Wanddicke	h_{min} [mm]	115	115	115
Bürste HIT-RB	- [-]	10	12	14
Maximales Anzugsdrehmoment	T_{max} [Nm]	5	8	10

Tabelle B8: Montagekennwerte Innengewindehülse HIT-IC in Vollstein (Bild A3)

HIT-IC		M8x80	M10x80	M12x80
Bohrernennendurchmesser	d_0 [mm]	14	16	18
Bohrlochtiefe = Effektive Verankerungstiefe	$h_0 =$ h_{ef} [mm]	80	80	80
Einschraubtiefe	h_s [mm]	8...75	10...75	12...75
Maximaler Durchmesser des Durchgangslochs im Anbauteil	d_f [mm]	9	12	14
Minimale Wanddicke	h_{min} [mm]	115	115	115
Bürste HIT-RB	- [-]	14	16	18
Maximales Anzugsdrehmoment	T_{max} [Nm]	5	8	10

Hilti HIT-HY 170

Verwendungszweck
Montagekennwerte.

Anhang B7

Tabelle B9: Maximale Verarbeitungszeit und minimale Aushärtezeit für Vollsteine ¹⁾

Temperatur im Verankerungsgrund T	Maximale Verarbeitungszeit t_{work}	Minimale Aushärtezeit t_{cure}
5 °C bis 10 °C	8 min	2,5 h
> 10 °C bis 20 °C	5 min	1,5 h
> 20 °C bis 30 °C	3 min	45 min
> 30 °C bis 40 °C	2 min	30 min

¹⁾ Die Aushärtezeiten gelten nur für trockenen Verankerungsgrund.
In feuchtem Verankerungsgrund müssen die Aushärtezeiten verdoppelt werden.

Tabelle B10: Maximale Verarbeitungszeit und minimale Aushärtezeit ¹⁾ für Lochsteine

Temperatur im Verankerungsgrund T	Maximale Verarbeitungszeit t_{work}	Minimale Aushärtezeit t_{cure}
-5 °C bis 0 °C	10 min	12 h
> 0 °C bis 5 °C	10 min	5 h
> 5 °C bis 10 °C	8 min	2,5 h
> 10 °C bis 20 °C	5 min	1,5 h
> 20 °C bis 30 °C	3 min	45 min
> 30 °C bis 40 °C	2 min	30 min

¹⁾ Die Aushärtezeiten gelten nur für trockenen Verankerungsgrund.
In feuchtem Verankerungsgrund müssen die Aushärtezeiten verdoppelt werden.

Tabelle B11: Reinigungswerkzeuge

Handreinigung (MC):

zum Ausblasen von Bohrlöchern wird die Hilti-Handausblaspumpe empfohlen.



Druckluftreinigung (CAC) ¹⁾:

zum Ausblasen von Bohrlöchern wird auch eine Ausblasdüse mit einem Durchmesser von mindestens 3,5 mm empfohlen.



Stahlbürste HIT-RB:

gemäß Tabelle B5 bis B8 in Abhängigkeit vom Bohrlochdurchmesser für MC und CAC.



¹⁾ Druckluftreinigung ist auch erlaubt.

Hilti HIT-HY 170

Verwendungszweck
Maximale Verarbeitungszeit und minimale Aushärtezeit.
Reinigungswerkzeuge.

Anhang B8

Montageanweisung

Bohrlocherstellung

Wenn beim Bohren über die gesamte Bohrlochtiefe (z. B. in nicht verfüllten Stoßfugen) kein nennenswerter Bohrwiderstand spürbar ist, so ist diese Setzposition zu verwerfen.

Bohrverfahren

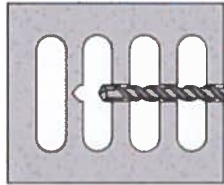

Im Hohlstein (Nutzungskategorie c): Drehbohren

Bohrloch mit Bohrhammer im Drehmodus unter Verwendung des passenden Bohrerdurchmessers auf die richtige Bohrtiefe erstellen.

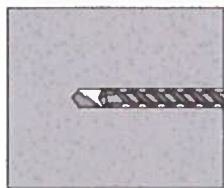

Im Vollstein (Nutzungskategorie b): Hammerbohren

Bohrloch mit Bohrhammer drehschlagend unter Verwendung des passenden Bohrerdurchmessers auf die richtige Bohrtiefe erstellen.

Bohrlochreinigung

Unmittelbar vor dem Setzen des Dübels muss das Bohrloch frei von Bohrmehl und Verunreinigungen sein. Schlechte Bohrlochreinigung = geringe Traglasten.

Handreinigung (MC) für Lochsteine und Vollsteine

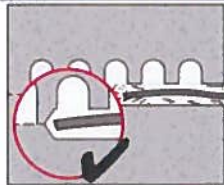

Bohrloch mindestens 2-mal mit der Hilti Ausblaspumpe vom Bohrlochgrund ausblasen bis die rückströmende Luft staubfrei ist.

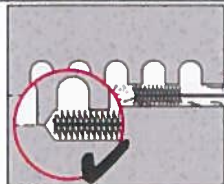

2-mal mit Stahlbürste in passender Größe (siehe Tabelle B5 bis Tabelle B8) bürsten. Stahlbürste Hilti HIT-RB mit einer Drehbewegung in das Bohrloch bis zum Bohrlochgrund einführen und wieder herausziehen. Die Bürste muss beim Einführen einen Widerstand erzeugen (Bürste $\varnothing \geq$ Bohrloch \varnothing) – falls nicht, ist die Bürste zu klein und muss durch eine geeignete Bürste ersetzt werden.

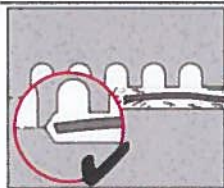

Bohrloch erneut mit der Hilti Handausblaspumpe vom Bohrlochgrund mindestens 2-mal ausblasen bis die rückströmende Luft staubfrei ist.

Hilti HIT-HY 170

Verwendungszweck
Montageanweisung.

Anhang B9

Injektionsvorbereitung bei Mauerwerk mit Lochanteil und Hohlräumen: Montage mit Siebhülse HIT-SC



Siebhülse HIT-SC
Kappe aufstecken.

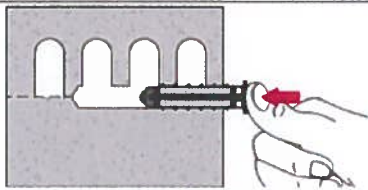

Siebhülse manuell einschieben.

Für alle Anwendungen

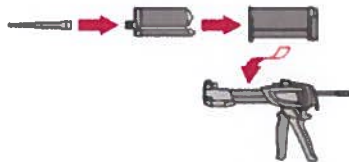

Statikmischer HIT-RE-M fest auf Foliengebinde aufschrauben.
Den Mischer unter keinen Umständen verändern.
Bedienungsanleitung des Auspressgerätes und des Mörtels befolgen.
Prüfen der Kassette und des Foliengebindes auf einwandfreie Funktion.
Kein beschädigtes Gebinde / Kassette verwenden.
Foliengebinde in die Kassette einführen und Kassette in Auspressgerät einsetzen.



Das Öffnen der Foliengebinde erfolgt automatisch bei Auspressbeginn. Der am Anfang aus dem Mischer austretende Mörtelvorlauf darf nicht für Befestigungen verwendet werden. Die Menge des Mörtelvorlaufes ist abhängig von der Gebindegröße:
2 Hübe bei 330 ml Foliengebinde,
3 Hübe bei 500 ml Foliengebinde.

Injektion des Mörtels ohne Luftblasen zu bilden

Montage mit Siebhülse HIT-SC

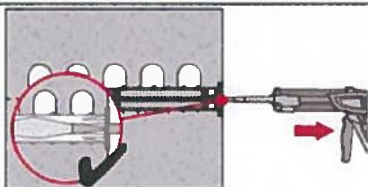

Siebhülse HIT-SC
Den Mischer ca. 1 cm in die Kappe einschieben. Die gemäß Tabelle B5 und Tabelle B6 angegebene Mörtelmenge injizieren. Mörtel muss aus der Kappe austreten.

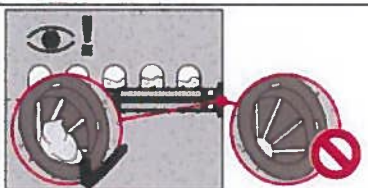

Kontrolle der injizierten Mörtelmenge. Der Mörtel muss aus der Kappe ausgetreten sein.

Nach der Mörtelinjektion die Entriegelungstaste am Auspressgerät betätigen, um Mörtelnachlauf zu vermeiden.

Hilti HIT-HY 170

Verwendungszweck
Montageanweisung.

Anhang B10

Vollsteine: Montage ohne Siebhülse

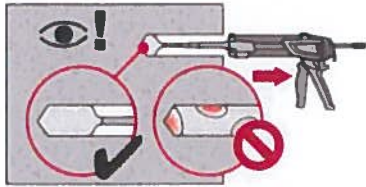

Injizieren des Mörtels vom Bohrlochgrund und während jedes Hubes den Mischer zurückziehen.

Das Bohrloch zu ca. 2/3 verfüllen. Nach dem Einsetzen des Befestigungselementes muss der Ringspalt zwischen Dübel und Untergrund über die gesamte Verankerungstiefe vollständig mit Mörtel ausgefüllt sein.

Nach der Mörtelinjektion die Entriegelungstaste am Auspressgerät betätigen, um Mörtelnachlauf zu vermeiden.

Setzen des Befestigungselementes:

Vor der Montage sicherstellen, dass das Element trocken und frei von Öl und anderen Verunreinigungen ist.

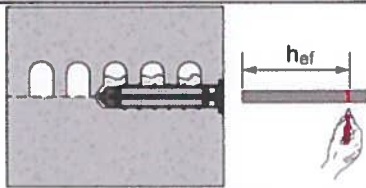

HIT-V-... oder HIT-IC in Lochstein und Vollstein: Vorsteckmontage (Bild A1 bis Bild A3)

Befestigungselement markieren und bis zur gewünschten Verankerungstiefe einführen, noch bevor die Verarbeitungszeit t_{work} abgelaufen ist. Verarbeitungszeit t_{work} siehe Tabelle B9 und Tabelle B10.

Belasten des Dübels

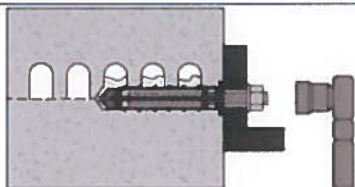

Nach Ablauf der Aushärtezeit t_{cure} (siehe Tabelle B9 und Tabelle B10) kann der Dübel belastet werden.







Das aufzubringende Drehmoment darf die angegebenen Werte T_{max} gemäß Tabelle B5 bis Tabelle B8 nicht überschreiten.

Hilti HIT-HY 170

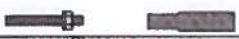
Verwendungszweck
Montageanweisung.

Anhang B11

Tabelle C1: β -Faktor für Baustellenversuche unter Zugbelastung

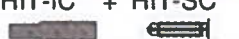
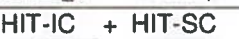
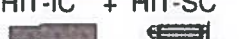
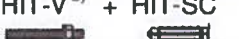
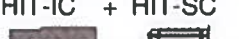
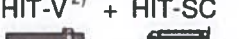
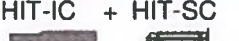
Nutzungskategorien		w/w und w/d		d/d	
Temperatur Bereich		Ta ¹⁾	Tb ¹⁾	Ta ¹⁾	Tb ¹⁾
Art des Mauersteins	Elementen				
Vollziegel EN 771-2	HIT-V ²⁾ oder HIT-IC 	0,97	0,83	0,97	0,83
	HIT-V ²⁾ + HIT-SC 				
	HIT-IC + HIT-SC 				
Kalksandvollstein EN 771-2	HIT-V ²⁾ oder HIT-IC 	0,96	0,84	0,97	0,84
	HIT-V ²⁾ + HIT-SC 	0,69	0,62	0,91	0,82
	HIT-IC + HIT-SC 				
Lochziegel EN 771-1	HIT-V ²⁾ + HIT-SC 	0,97	0,83	0,97	0,83
	HIT-IC + HIT-SC 				
Kalksandlochstein EN 771-2	HIT-V ²⁾ + HIT-SC 	0,69	0,62	0,91	0,82
	HIT-IC + HIT-SC 				
Leichtbeton Hohlblockstein EN 771-3	HIT-V ²⁾ + HIT-SC 	0,89	0,81	0,97	0,86
	HIT-IC + HIT-SC 				
Normalbeton Lochstein EN 771-3	HIT-V ²⁾ + HIT-SC 	0,97	0,80	0,97	0,80
	HIT-IC + HIT-SC 				

¹⁾ Temperaturbereich Ta / Tb siehe Anhang B1.

²⁾ Handelsübliche Gewindestangen können ebenfalls verwendet werden.

Hilti HIT-HY 170

Leistung
 β -Faktor für Baustellenversuche unter Zugbelastung.

Anhang C1

Tabelle C2: Charakteristische Werte der Stahltragfähigkeit für Gewindestange, HIT-V-... unter Zuglast und Querlast in Mauerwerk

HIT-HY 170 mit Gewindestange, HIT-V-...		M8	M10	M12
Stahlversagen Zuglast				
Charakteristische Stahlwiderstand	$N_{Rk,s}$ [kN]	$A_s \cdot f_{uk}$		
Stahlversagen Querlast ohne Hebelarm				
Charakteristische Stahlwiderstand	$V_{Rk,s}$ [kN]	$0,5 \cdot A_s \cdot f_{uk}$		
Stahlversagen Querlast mit Hebelarm				
Charakteristische Biegemoment	$M_{Rk,s}$ [Nm]	$1,2 \cdot W_{el} \cdot f_{uk}$		

Tabelle C3: Charakteristische Werte der Stahltragfähigkeit für Innengewindehülse HIT-IC unter Zuglast und Querlast in Mauerwerk

HIT-HY 170 mit HIT-IC		M8	M10	M12
Stahlversagen Zuglast				
Charakteristische Stahlwiderstand	$N_{Rk,s}$ [kN]	5,9	7,3	13,8
Teilsicherheitsbeiwert	$\gamma_{Ms,N}$ [-]	1,50		
Stahlversagen Querlast ohne Hebelarm				
Charakteristische Stahlwiderstand	$V_{Rk,s}$ [kN]	$0,5 \cdot A_s \cdot f_{uk}$		
Stahlversagen Querlast mit Hebelarm				
Charakteristische Biegemoment	$M_{Rk,s}$ [Nm]	$1,2 \cdot W_{el} \cdot f_{uk}$		

Hilti HIT-HY 170

Leistung

Charakteristische Werte unter Zuglast und Querlast – Stahlversagen.

Anhang C2

Art des Mauersteins: Vollziegel Mz, 2DF

Tabelle C4: Beschreibung des Mauersteins

Steintyp		[-]	Mz, 2DF	
Rohdichte	ρ	[kg/dm ³]	≥ 2,0	
Druckfestigkeit	f_b	[N/mm ²]	≥ 12	
Norm		[-]	EN 771 - 1	
Hersteller		[-]	-	
Steinabmessungen		[mm]	≥ 240 x 115 x 113	
Minimale Wanddicke	h_{min}	[mm]	≥ 115	







Tabelle C5: Montageparameter für alle Dübelkombinationen (siehe Tabelle B3)

Befestigungselement		siehe Tabelle B3
Randabstand	$c_{min} = c_{cr}$ [mm]	115
Achsabstand	$s_{min \parallel} = s_{cr \parallel}$ [mm]	240
	$s_{min \perp} = s_{cr \perp}$ [mm]	115

Tabelle C6: Gruppenfaktor für Gruppenbefestigungen

Gruppenfaktor	$\alpha_{g,N \parallel} \alpha_{g,V \parallel} \alpha_{g,N \perp} \alpha_{g,V \perp}$ [-]	2 bei c_{cr} und s_{cr}
---------------	---	-----------------------------

Tabelle C7: Charakteristische Zugtragfähigkeit bei Randabstand $c \geq c_{cr}$

Nutzungskategorie				w/w = w/d		d/d	
Gebrauchstemperaturbereich				(Ta)	(Tb)	(Ta)	(Tb)
Dübeltyp und -größe	h_{ef} [mm]	f_b [N/mm ²]	N_{Rk} [kN]				
HIT-V ¹⁾  M8, M10, M12	80	12	3,0	2,5	3,0	2,5	
HIT-IC  M8 M10, M12	80	12	3,0	2,5	3,0	2,5	
			4,0	3,5	4,0	3,5	
HIT-V ¹⁾ + HIT-SC   M8, M10, M12	80	12	4,0	3,5	4,0	3,5	
HIT-IC + HIT-SC   M8, M10, M12	80	12	4,0	3,5	4,0	3,5	

¹⁾ Handelsübliche Gewindestangen können ebenfalls verwendet werden.

Tabelle C8: Charakteristische Quertragfähigkeit bei Randabstand $c \geq c_{cr}$

Nutzungskategorie				w/w = w/d		d/d	
Gebrauchstemperaturbereich				(Ta)	(Tb)	(Ta)	(Tb)
Dübeltyp und -größe	h_{ef} [mm]	f_b [N/mm ²]	V_{Rk} [kN]				
Alle Dübel	M8, M10, M12	80	12	3,5			

Tabelle C9: Verschiebungen

h_{ef} [mm]	N [kN]	δ_{N0} [mm]	$\delta_{N\infty}$ [mm]	V [kN]	δ_{V0} [mm]	$\delta_{V\infty}$ [mm]
80	0,9	0,2	0,4	1,0	1,0	1,5

Hilti HIT-HY 170

Leistung Vollziegel Mz, 2DF
Montageparameter und Gruppenfaktor.
Charakteristische Werte der Tragfähigkeit unter Zug- und Querlast. Verschiebungen.

Anhang C3

Art des Mauersteins: Kalksandvollstein KS, 2DF

Tabelle C10: Beschreibung des Mauersteins

Steintyp		[-]	KS, 2DF	
Rohdichte	ρ	[kg/dm ³]	≥ 2,0	
Druckfestigkeit	f_b	[N/mm ²]	≥ 12 oder ≥ 28	
Norm		[-]	EN 771 - 2	
Hersteller		[-]	-	
Steinabmessungen		[mm]	≥ 240 x 115 x 113	
Minimale Wanddicke	h_{min}	[mm]	≥ 115	





Tabelle C11: Montageparameter für alle Dübelkombinationen (siehe Tabelle B3)

Befestigungselement			siehe Tabelle B3
Randabstand	$c_{min} = c_{cr}$	[mm]	115
Achsabstand	$s_{min \parallel} = s_{cr \parallel}$	[mm]	240
	$s_{min \perp} = s_{cr \perp}$	[mm]	115

Tabelle C12: Gruppenfaktor für Gruppenbefestigungen

Gruppenfaktor	$\alpha_{g,N \parallel} \alpha_{g,V \parallel} \alpha_{g,N \perp} \alpha_{g,V \perp}$	[-]	2 bei c_{cr} und s_{cr}
---------------	---	-----	-----------------------------

Tabelle C13: Charakteristische Zugtragfähigkeit bei Randabstand $c \geq c_{cr}$

Nutzungskategorie			w/w = w/d		d/d	
Gebrauchstemperaturbereich			(Ta)	(Tb)	(Ta)	(Tb)
Dübeltyp und -größe	h_{ef} [mm]	f_b [N/mm ²]	N_{Rk} [kN]			
HIT-V ¹⁾  M8, M10, M12	80	12	5,5	5,0	6,0	5,0
HIT-IC 		28	8,5	7,5	8,5	7,5
HIT-V ¹⁾ + HIT-SC  M8, M10, M12	80	12	4,0	3,5	5,5	5,0
HIT-IC + HIT-SC 		28	6,0	5,5	8,0	7,5

¹⁾ Handelsübliche Gewindestangen können ebenfalls verwendet werden.

Tabelle C14: Charakteristische Quertragfähigkeit bei Randabstand $c \geq c_{cr}$

Nutzungskategorie			w/w = w/d		d/d	
Gebrauchstemperaturbereich			(Ta)	(Tb)	(Ta)	(Tb)
Dübeltyp und -größe	h_{ef} [mm]	f_b [N/mm ²]	V_{Rk} [kN]			
Alle Dübel M8, M10, M12	80	12	4,0			
		28	6,0			

Tabelle C15: Verschiebungen

h_{ef} [mm]	N [kN]	δ_{N0} [mm]	$\delta_{N\infty}$ [mm]	V [kN]	δ_{V0} [mm]	$\delta_{V\infty}$ [mm]
80	2,3	0,2	0,4	1,5	1,2	1,8

Hilti HIT-HY 170

Leistung Kalksandvollstein KS, 2DF
Montageparameter und Gruppenfaktor.
Charakteristische Werte der Tragfähigkeit unter Zug- und Querlast. Verschiebungen.

Anhang C4

Art des Mauersteins: Lochziegel Hlz, 10DF

Tabelle C16: Beschreibung des Mauersteins

Steintyp	[-]	Hlz 12-1,4-10 DF	 <p>Steinzeichnung siehe Tabelle B4</p>
Rohdichte	ρ [kg/dm ³]	$\geq 1,4$	
Druckfestigkeit	f_b [N/mm ²]	≥ 12 oder ≥ 20	
Norm	[-]	EN 771 - 1	
Hersteller	[-]	Rapis (D)	
Steinabmessungen	[mm]	300 x 240 x 238	
Minimale Wanddicke	h_{min} [mm]	≥ 240	





Tabelle C17: Montageparameter für alle Dübelkombinationen (siehe Tabelle B3)

Dübeltyp	siehe Tabelle B3	
Randabstand	$c_{min} = c_{cr}$ [mm]	150
Achsabstand	$s_{min \parallel} = s_{cr \parallel}$ [mm]	300
	$s_{min \perp} = s_{cr \perp}$ [mm]	240

Tabelle C18: Gruppenfaktor für Gruppenbefestigungen





Gruppenfaktor	$\alpha_{q,N \parallel} \alpha_{q,V \parallel} \alpha_{q,N \perp} \alpha_{q,V \perp}$ [-]	2 bei c_{cr} und s_{cr}
---------------	---	-----------------------------

Tabelle C19: Charakteristische Zugtragfähigkeit bei Randabstand $c \geq c_{cr}$

Nutzungskategorie			w/w = w/d		d/d	
Gebrauchstemperaturbereich			(Ta)	(Tb)	(Ta)	(Tb)
Dübeltyp und -größe	h_{ef} [mm]	f_b [N/mm ²]	N_{Rk} [kN]			
HIT-V ¹⁾ + HIT-SC   M8, M10, M12	80	12	3,0	2,5	3,0	2,5
HIT-IC + HIT-SC  		20	3,5	3,0	3,5	3,0

¹⁾ Handelsübliche Gewindestangen können ebenfalls verwendet werden.

Tabelle C20: Charakteristische Quertragfähigkeit bei Randabstand $c \geq c_{cr}$

Nutzungskategorie			w/w = w/d		d/d	
Gebrauchstemperaturbereich			(Ta)	(Tb)	(Ta)	(Tb)
Dübeltyp und -größe	h_{ef} [mm]	f_b [N/mm ²]	V_{Rk} [kN]			
HIT-V ¹⁾ + HIT-SC   M8, M10, M12	80	12	2,0			
HIT-IC + HIT-SC  		20	3,0			

¹⁾ Handelsübliche Gewindestangen können ebenfalls verwendet werden.

Tabelle C21: Verschiebungen

h_{ef} [mm]	N [kN]	δ_{N0} [mm]	δ_{Nc} [mm]	V [kN]	δ_{V0} [mm]	δ_{Vc} [mm]
80	0,9	0,2	0,3	0,9	1,0	1,5

Hilti HIT-HY 170

Leistung Lochziegel Hlz, 10DF
Montageparameter und Gruppenfaktor.
Charakteristische Werte der Tragfähigkeit unter Zug- und Querlast. Verschiebungen.

Anhang C5

Art des Mauersteins: Kalksandlochstein KSL, 8DF

Tabelle C22: Beschreibung des Mauersteins

Steintyp				KSL-12-1,4-8 DF	 Steinzeichnung siehe Tabelle B4
Rohdichte	ρ	[kg/dm ³]		≥ 1,4	
Druckfestigkeit	f_b	[N/mm ²]		≥ 12 oder ≥ 20	
Norm				EN 771 – 2	
Hersteller				KS Südbayern (D)	
Steinabmessungen		[mm]		248 x 240 x 238	
Minimale Wanddicke	h_{min}	[mm]		≥ 240	





Tabelle C23: Montageparameter für alle Dübelkombinationen (siehe Tabelle B3)

Dübeltyp		siehe Tabelle B3
Randabstand	$c_{min} = c_{cr}$ [mm]	125
Achsabstand	$s_{min \parallel} = s_{cr \parallel}$ [mm]	248
	$s_{min \perp} = s_{cr \perp}$ [mm]	240

Tabelle C24: Gruppenfaktor für Gruppenbefestigungen





Gruppenfaktor	$\alpha_{q,N \parallel} \alpha_{q,V \parallel} \alpha_{q,N \perp} \alpha_{q,V \perp}$ [-]	2 bei c_{cr} und s_{cr}
---------------	---	-----------------------------

Tabelle C25: Charakteristische Zugtragfähigkeit bei Randabstand $c \geq c_{cr}$

Nutzungskategorie			w/w = w/d		d/d	
Gebrauchstemperaturbereich			(Ta)	(Tb)	(Ta)	(Tb)
Dübeltyp und -größe	h_{ef} [mm]	f_b [N/mm ²]	N_{Rk} [kN]			
HIT-V ¹⁾ + HIT-SC   M8, M10, M12	80	12	3,0	2,5	3,5	3,0
HIT-IC + HIT-SC  		20	4,0	3,5	5,0	4,5

¹⁾ Handelsübliche Gewindestangen können ebenfalls verwendet werden.

Tabelle C26: Charakteristische Quertragfähigkeit bei Randabstand $c \geq c_{cr}$

Nutzungskategorie			w/w = w/d		d/d	
Gebrauchstemperaturbereich			(Ta)	(Tb)	(Ta)	(Tb)
Dübeltyp und -größe	h_{ef} [mm]	f_b [N/mm ²]	V_{Rk} [kN]			
HIT-V ¹⁾ + HIT-SC   M8, M10, M12	80	12	8,5			
HIT-IC + HIT-SC  		20	12,0			

¹⁾ Handelsübliche Gewindestangen können ebenfalls verwendet werden.

Tabelle C27: Verschiebungen

h_{ef} [mm]	N [kN]	δ_{N0} [mm]	$\delta_{N\infty}$ [mm]	V [kN]	δ_{V0} [mm]	$\delta_{V\infty}$ [mm]
80	1,8	0,2	0,3	3,4	2,5	3,8

Hilti HIT-HY 170

Leistung Kalksandlochstein KSL, 8DF
Montageparameter und Gruppenfaktor.
Charakteristische Werte der Tragfähigkeit unter Zug- und Querlast. Verschiebungen.

Anhang C6

Art des Mauersteins: Leichtbeton Hohlblockstein Hbl, 16DF

Tabelle C28: Beschreibung des Mauersteins

Steintyp		[-]	Hbl-4-0,7	 <p>Steinzeichnung siehe Tabelle B4</p>
Rohdichte	ρ	[kg/dm ³]	≥ 0,8	
Druckfestigkeit	f_b	[N/mm ²]	≥ 2 or ≥ 6	
Norm		[-]	EN 771-3	
Hersteller		[-]	Knobel (D)	
Steinabmessungen		[mm]	495 x 240 x 238	
Minimale Wanddicke	h_{min}	[mm]	≥ 240	



Tabelle C29: Montageparameter für alle Dübelkombinationen (siehe Tabelle B3)

Dübeltyp	siehe Tabelle B3	
Randabstand	$c_{min} = c_{cr}$ [mm]	250
Achsabstand	$s_{min \parallel} = s_{cr \parallel}$ [mm]	240
	$s_{min \perp} = s_{cr \perp}$ [mm]	240

Tabelle C30: Gruppenfaktor für Gruppenbefestigungen



Gruppenfaktor	$\alpha_{q,N \parallel} \alpha_{q,V \parallel} \alpha_{q,N \perp} \alpha_{q,V \perp}$ [-]	2 bei c_{cr} und s_{cr}
---------------	---	-----------------------------

Tabelle C31: Charakteristische Zugtragfähigkeit bei Randabstand $c \geq c_{cr}$

Nutzungskategorie			w/w = w/d		d/d	
Gebrauchstemperaturbereich			(Ta)	(Tb)	(Ta)	(Tb)
Dübeltyp und -größe	h_{ef} [mm]	f_b [N/mm ²]	N_{Rk} [kN]			
HIT-V ¹⁾ + HIT-SC  M8, M10, M12	80	2	1,2	0,9	1,5	1,2
HIT-IC + HIT-SC  M8, M10, M12		6	2,0	1,5	2,5	2,0

¹⁾ Handelsübliche Gewindestangen können ebenfalls verwendet werden.

Tabelle C32: Charakteristische Quertragfähigkeit bei Randabstand $c \geq c_{cr}$

Nutzungskategorie			w/w = w/d		d/d	
Gebrauchstemperaturbereich			(Ta)	(Tb)	(Ta)	(Tb)
Dübeltyp und -größe	h_{ef} [mm]	f_b [N/mm ²]	V_{Rk} [kN]			
HIT-V ¹⁾ + HIT-SC  M8, M10, M12	80	2	2,5			
HIT-IC + HIT-SC  M8, M10, M12		6	4,0			

¹⁾ Handelsübliche Gewindestangen können ebenfalls verwendet werden.

Tabelle C33: Verschiebungen

h_{ef} [mm]	N [kN]	δ_{N0} [mm]	$\delta_{N\infty}$ [mm]	V [kN]	δ_{V0} [mm]	$\delta_{V\infty}$ [mm]
80	2,4	0,2	0,4	3,4	1,3	1,9

Hilti HIT-HY 170

Leistung Leichtbeton Hohlblockstein Hbl, 16DF
Montageparameter und Gruppenfaktor.
Charakteristische Werte der Tragfähigkeit unter Zug- und Querlast. Verschiebungen.

Anhang C7

Art des Mauersteins: Normalbeton Lochstein - parpaing creux

Tabelle C34: Beschreibung des Mauersteins

Steintyp	[-]	B40	 <p>Steinzeichnung siehe Tabelle B4</p>
Rohdichte	ρ [kg/dm ³]	$\geq 0,9$	
Druckfestigkeit	f_b [N/mm ²]	≥ 4 oder ≥ 10	
Norm	[-]	EN 771-3	
Hersteller	[-]	Fabemi (F)	
Steinabmessungen	[mm]	500 x 200 x 200	
Minimale Wanddicke	h_{min} [mm]	≥ 200	





Tabelle C35: Montageparameter für alle Dübelkombinationen (siehe Tabelle B3)

Dübeltyp	siehe Tabelle B3	
Randabstand	$c_{min} = c_{cr}$ [mm]	200
Achsabstand	$s_{min \parallel} = s_{cr \parallel}$ [mm]	200
	$s_{min \perp} = s_{cr \perp}$ [mm]	200

Tabelle C36: Gruppenfaktor für Gruppenbefestigungen





Gruppenfaktor	$\alpha_{q,N \parallel} \alpha_{q,V \parallel} \alpha_{q,N \perp} \alpha_{q,V \perp}$ [-]	2 bei c_{cr} und s_{cr}
---------------	---	-----------------------------

Tabelle C37: Charakteristische Zugtragfähigkeit bei Randabstand $c \geq c_{cr}$

Nutzungskategorie			w/w = w/d		d/d	
Gebrauchstemperaturbereich			(Ta)	(Tb)	(Ta)	(Tb)
Dübeltyp und -größe	h_{ef} [mm]	f_b [N/mm ²]	N_{Rk} [kN]			
HIT-V ¹⁾ + HIT-SC   M8, M10, M12	80	4	0,9	0,9	0,9	0,9
HIT-IC + HIT-SC  		10	1,2	1,2	1,5	1,5

¹⁾ Handelsübliche Gewindestangen können ebenfalls verwendet werden.

Tabelle C38: Charakteristische Quertragfähigkeit bei Randabstand $c \geq c_{cr}$

Nutzungskategorie			w/w = w/d		d/d	
Gebrauchstemperaturbereich			(Ta)	(Tb)	(Ta)	(Tb)
Dübeltyp und -größe	h_{ef} [mm]	f_b [N/mm ²]	V_{Rk} [kN]			
HIT-V ¹⁾ + HIT-SC   M8, M10, M12	80	4	2,5			
HIT-IC + HIT-SC  		10	4,0			

¹⁾ Handelsübliche Gewindestangen können ebenfalls verwendet werden.

Tabelle C39: Verschiebungen

h_{ef} [mm]	N [kN]	δ_{N0} [mm]	δ_{N100} [mm]	V [kN]	δ_{V0} [mm]	δ_{V100} [mm]
80	1,0	0,6	1,2	2,3	0,6	0,9

Hilti HIT-HY 170

Leistung Normalbeton Lochstein - parpaing creux
Montageparameter und Gruppenfaktor.
Charakteristische Werte der Tragfähigkeit unter Zug- und Querlast. Verschiebungen.

Anhang C8

Evaluation Technique Européenne

ETE-15/0197
du 9 décembre 2015

Traduction en langue française par Hilti – Version originale en allemand

Partie générale

Organisme d'évaluation technique ayant délivré l'évaluation technique européenne

Deutsches Institut für Bautechnik

Nom commercial
Trade name

Système d'injection Hilti HIT-HY 170
Injection system Hilti HIT-HY 170

Famille de produit à laquelle appartient le produit de la construction

Système d'injection pour utilisation dans les maçonneries

Product family to which the construction product belongs

Injection system for use in masonry

Fabriquant
Manufacturer

Hilti
Feldkirchstrasse 100
FL-9494 Schaan
Fürstentum Liechtenstein

Usine de production
Manufacturing plant

Usines Hilti

Cette évaluation technique européenne contient

26 pages incluant 3 annexes qui font partie intégrante de l'évaluation

Cette évaluation technique européenne est délivrée selon le règlement (EU) N° 305/2011, sur la base de

Guide pour agrément technique européen ETAG 029 « Chevilles pour les maçonneries », avril 2013, utilisé comme Document d'Evaluation Européenne (DEE) selon l'article 66 Paragraphe 3 du règlement (EU) N° 305/2011

Cette évaluation remplace

ETE 15/0197 délivrée le 28 avril 2015

L'évaluation technique européenne est délivrée par l'organisme d'agrément dans sa langue officielle. Toutes les traductions dans d'autres langues doivent correspondre parfaitement et doivent être clairement indiquées.

La reproduction de cette évaluation technique européenne, y compris par voie électronique, n'est autorisée que sous sa forme intégrale, sauf accord écrit du DIBT (Deutsches Institut für Bautechnik). Dans le cas d'un tel accord, il doit être clairement indiqué que la reproduction n'est que partielle.

Cette évaluation technique européenne peut être annulée par l'organisme l'ayant délivrée notamment après notification de la Commission sur la base de l'article 25, paragraphe 3, du règlement (EU) N° 305/2011.

Partie spécifique

1 Définition technique du produit

Le système à injection Hilti HIT-HY 170 pour maçonneries est une cheville à scellement (injection) consistant en une cartouche de résine Hilti HIT-HY 170, un tamis creux perforé et une tige d'ancrage avec écrou et rondelle de dimension M8 à M12 ou une douille taraudée de dimension M8 à M12. Les éléments en acier sont en acier électrozingué, acier inoxydable ou acier à haute résistance à la corrosion.

L'élément en acier est placé dans un trou foré rempli de résine et ancré via l'adhérence et/ou le verrouillage mécanique entre l'élément en acier, la résine et la maçonnerie.

Un schéma et une description du produit sont donnés en annexe A.

2 Spécification de l'usage prévu selon le DEE applicable

Les performances données en section 3 ne sont valides que si la cheville est utilisée conformément aux spécifications et conditions données en annexe B.

Les dispositions prises dans la présente Evaluation Technique Européenne reposent sur l'hypothèse que la durée de vie estimée de la cheville pour l'utilisation prévue est de 50 ans. Les indications relatives à la durée de vie ne peuvent pas être interprétées comme une garantie donnée par le fabricant, mais ne doivent être considérées que comme un moyen pour choisir le produit qui convient à la durée de vie économiquement raisonnable attendue des ouvrages.

3 Performances du produit et référence à la méthode d'essai utilisée pour l'évaluation

3.1 Résistance mécanique et stabilité (exigence 1)

Exigence fondamentale	Performance
Valeurs caractéristiques de résistance pour les éléments en acier	Voir annexe C2
Valeurs caractéristiques de résistance des chevilles dans les maçonneries	Voir annexes C3-C8
Déplacements sous charges de traction et cisaillement	Voir annexes C3-C8
Facteur de réduction pour les essais sur chantier (coefficient β)	Voir annexe C1
Distances au bord et entraxe	Voir annexes C3-C8
Coefficient de groupes	Voir annexes C3-C8

3.2 Sécurité en cas d'incendie (exigence 2)

Exigence fondamentale	Performance
Réaction au feu	Classe A1
Résistance au feu	Aucune performance déterminée (NPD)

3.3 Hygiène, santé et sécurité (exigence 3)

Outre les clauses spécifiques se rapportant aux substances dangereuses, contenues dans la présente évaluation technique européenne, il se peut que d'autres exigences soient applicables aux produits couverts par le domaine d'application de l'ETE (par exemple législation européenne et législations nationales transposées, réglementations et dispositions administratives). Pour être conforme aux dispositions du Règlement Produits de la Construction (EU) N° 305/2011, ces exigences doivent également être satisfaites là où elles s'appliquent.

3.4 Sécurité d'utilisation et accessibilité (exigence 4)

Pour l'exigence fondamentale Sécurité d'utilisation, les critères sont les mêmes que pour l'exigence fondamentale Résistance mécanique et stabilité.

4 Système d'évaluation et vérification de la constance des performances appliqué et base légale

Conformément au guide ETAG 029, édition Avril 2013 utilisé comme document d'évaluation européenne (DEE) selon le paragraphe 3 de l'article 66 du règlement (EU) N° 305/2011 donné dans le tableau suivant s'applique, le document légal s'appliquant est le : [97/177/CE].

Le système qui s'applique est le : système 1

5 Détails techniques nécessaires pour la mise en œuvre du système d'évaluation et vérification de la constance des performances, selon le DEE applicable

Les détails techniques nécessaires à la mise en œuvre du système d'évaluation et vérification de la constance des performances sont donnés dans le plan de contrôle déposé au deutsches Institut für Bautechnik.

Délivré à Berlin le 9 décembre 2015 par le deutsches Institut für Bautechnik

Uwe Bender
Chef du département

beglaubigt :
Wittstock

Produit posé

Figure A1 : Maçonnerie creuse et pleine avec tige filetée HIT-V-... et un tamis HIT-SC (voir tableau B5), ou avec douille taraudée HIT-IC et un tamis HIT-SC (voir tableau B6)

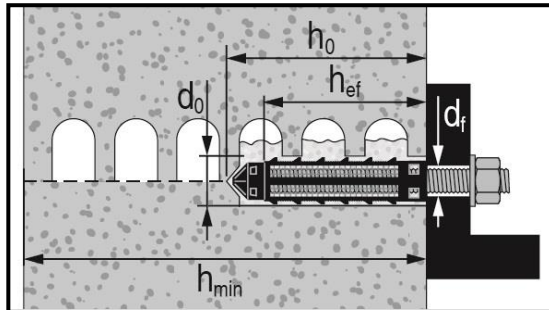

Figure A2 : Maçonnerie pleine avec tige filetée HIT-V-... (voir tableau B7)

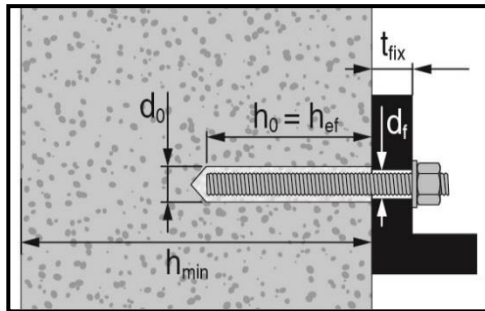
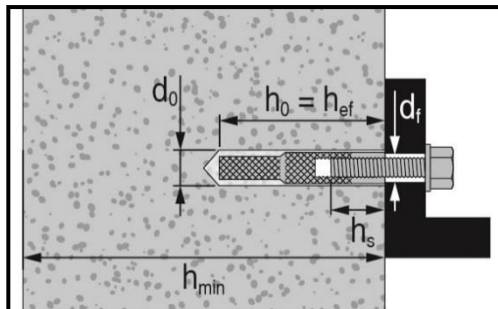

Figure A3 : Maçonnerie pleine avec douille taraudée HIT-IC (voir tableau B8)



Système Hilti HIT-HY 170

Description du produit

Condition de pose

Annexe A1

Description du produit : Résine d'injection et éléments en acier

Résine d'injection Hilti HIT-HY 170: Système hybride avec agrégats
Cartouche souple 330ml et 500ml

Marquage
 HILTI HIT
 Numéro de production et de
 ligne de production
 Date de péremption mm/aaaa



Nom du produit: « Hilti HIT-HY 170 »

Buse mélangeuse Hilti HIT-RE-M



Tige filetée HIT-V-... M8 à M12

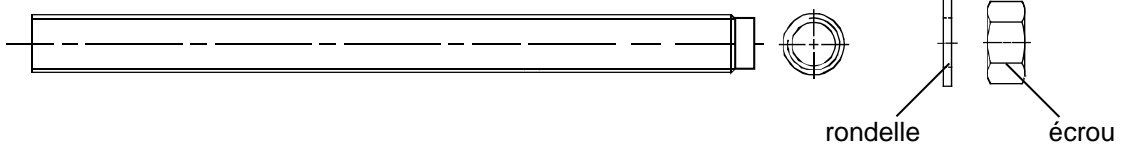

Tiges filetées du commerce avec :

- Matériaux, dimensions et propriétés mécaniques selon Tableau A1
- Certificat de contrôle 3.1 selon EN 10204:2004
- Marquage de la profondeur d'implantation

Douille taraudée HIT-IC M8 à M12

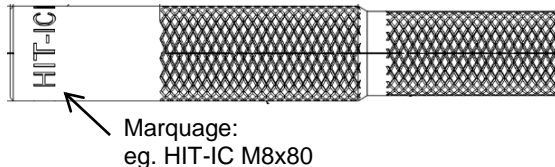

Marquage:
 eg. HIT-IC M8x80

Tamis HIT- SC 16 à 22

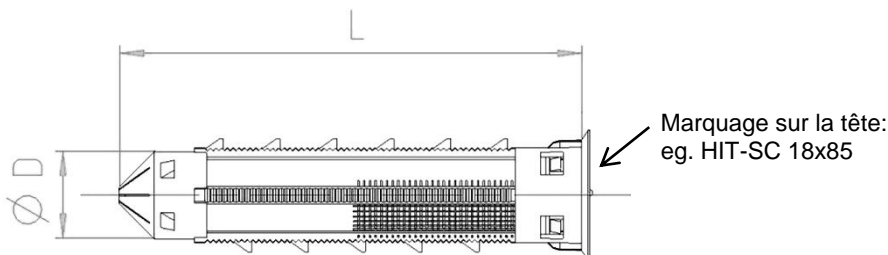

Marquage sur la tête:
 eg. HIT-SC 18x85

Système Hilti HIT-HY 170

Description du produit

Résine / Buse / Eléments d'ancrage / Tamis

Annexe A2

Tableau A1 : Matériaux

Désignation	Matériau
Parties métalliques en acier zingué	
Tige filetée HIT-V-5.8(F)	Classe de résistance 5.8, $f_{u,k} = 500 \text{ N/mm}^2$; $f_{y,k} = 400 \text{ N/mm}^2$, Elongation à la rupture ($l_0 = 5d$) > ductilité 8% acier électro zingué $\geq 5 \mu\text{m}$, (F) version galvanisée à chaud $\geq 45 \mu\text{m}$
Tige filetée HIT-V-8.8(F)	Classe de résistance 8.8 $f_{u,k} = 800 \text{ N/mm}^2$; $f_{y,k} = 640 \text{ N/mm}^2$, Elongation à la rupture ($l_0 = 5d$) > ductilité 8% acier électro zingué $\geq 5 \mu\text{m}$, (F) version galvanisée à chaud $\geq 45 \mu\text{m}$
Douille taraudée HIT-IC	$f_{u,k} = 490 \text{ N/mm}^2$; $f_{y,k} = 390 \text{ N/mm}^2$, Elongation à la rupture ($l_0 = 5d$) > ductilité 8% acier électro zingué $\geq 5 \mu\text{m}$
Rondelle	Acier électro zingué $\geq 5 \mu\text{m}$ Galvanisée à chaud $\geq 45 \mu\text{m}$
Ecrou	Classe de résistance adaptée à la classe de résistance de la tige filetée, Acier électro zingué $\geq 5 \mu\text{m}$, Galvanisé à chaud $\geq 45 \mu\text{m}$
Parties métalliques en acier inoxydable	
Tige filetée HIT-V-R	Classe de résistance 70, $f_{u,k} = 700 \text{ N/mm}^2$; $f_{y,k} = 450 \text{ N/mm}^2$; Elongation à la rupture ($l_0 = 5d$) > ductilité 8% Acier inoxydable 1.4401; 1.4404; 1.4578; 1.4571; 1.4439; 1.4362 EN 10088-1:2014
Rondelle	Acier inoxydable 1.4401; 1.4404; 1.4578; 1.4571; 1.4439; 1.4362 EN 10088-1:2014
Ecrou	Classe de résistance adaptée à la classe de résistance de la tige filetée, Acier inoxydable 1.4401; 1.4404; 1.4578; 1.4571; 1.4439; 1.4362 EN 10088-1:2014
Parties métalliques en acier à haute résistance à la corrosion	
Tige filetée HIT-V-HCR	$f_{u,k} = 800 \text{ N/mm}^2$; $f_{y,k} = 640 \text{ N/mm}^2$; Elongation à la rupture ($l_0 = 5d$) > ductilité 8% Acier à haute résistance à la corrosion 1.4529, 1.4565 EN 10088-1:2014
Rondelle	Acier à haute résistance à la corrosion 1.4529, 1.4565 EN 10088-1:2014
Ecrou	Classe de résistance adaptée à la classe de résistance de la tige filetée, Acier à haute résistance à la corrosion 1.4529, 1.4565 EN 10088-1:2014
Parties plastiques	
Tamis HIT-SC	Cadre : FPP 20T Tamis : PA6.6 N500/200
Système Hilti HIT-HY 170	
Description du produit Matériaux	Annexe A3

Usage prévu

Matériaux de base :

- Maçonneries pleines (catégorie d'utilisation b), selon Annexe B3.
 Note : Les résistances caractéristiques sont également valides pour des briques de dimensions ou résistance à la compression plus grande.
- Maçonneries creuses (catégorie d'utilisation c), selon annexes B3 et B5.
- Mortier de classe de résistance : M2,5 minimum selon EN 998-2: 2010.
- Pour les autres maçonneries solides, creuses ou perforées, les résistances caractéristiques peuvent être déterminées avec des essais sur chantier selon l'annexe B du guide ETAG 029 avec le coefficient β donné dans le tableau C1 de l'annexe C1.

Tableau B1 : Résumé des catégories d'utilisation

Ancrages	HIT-HY 170 avec ... HIT-V or HIT-IC	
	Maçonnerie pleine	Maçonnerie creuse
Perçage du trou 	Percussion	Rotation uniquement
Charges statiques et quasi statiques	Annexes : C2 (acier), C3, C4	Annexes : C2 (acier), C5, C6, C7, C8
Catégorie d'utilisation: Structure sèche ou humide	Catégorie d/d - Installation et usage en structures soumises à des conditions intérieures sèches . Catégorie w/d - Installation sur structure sèche ou humide et usage en structures soumises à des conditions intérieures sèches (sauf maçonnerie en silico-calcaire). Catégorie w/w - Installation et usage en structures soumises à un environnement sec ou humide (sauf maçonnerie en silico-calcaire).	
Direction de pose des maçonneries	Horizontale	
Catégorie d'utilisation	b (maçonnerie pleine)	c (maçonnerie creuse ou perforée)
Température dans le matériau support à la pose	+5° C à +40° C (tableau B9)	-5° C à +40° C (tableau B10)
Température en service	Plage de température Ta:	-40 °C à +40 °C (température max à long terme + 24 °C et température max à court terme + 40 °C)
	Plage de température Tb:	-40 °C à +80 °C (température max à long terme + 50 °C et température max à court terme + 80 °C)

Systeme Hilti HIT-HY 170

Usage prévu
 Spécifications

Annexe B1

Usage prévu

Conditions d'utilisation (Environnement)

- Ancrages soumis à une ambiance intérieure sèche (éléments en acier électro zingué, en acier inoxydable et en acier à haute résistance à la corrosion)
- Ancrages soumis à une exposition atmosphérique extérieure (y compris atmosphère industrielle et à proximité de la mer) ou dans des locaux humides, pour autant que les conditions ambiantes ne soient pas particulièrement agressives (éléments en acier inoxydable et en acier à haute résistance à la corrosion)
- Ancrages soumis à une ambiance extérieure, dans des conditions humides permanentes ou autres conditions particulièrement agressives (éléments en acier inoxydable et en acier à haute résistance à la corrosion)

Note : De telles conditions particulièrement agressives sont par exemple immersion alternée et continue dans l'eau de mer ou zone soumise à des aspersion d'eau de mer, atmosphère contenant du chlore dans les piscines couvertes ou atmosphère soumise à pollution chimique extrême (p. ex. à proximité d'installations de désulfuration de gaz et fumées ou dans des tunnels routiers avec salage l'hiver).

Conception :

- Les ancrages sont conçus sous la responsabilité d'un ingénieur qualifié possédant une expérience approfondie des ancrages et ouvrages en maçonnerie.
- Tous plans et notes de calcul devront être établis de manière à être vérifiables, compte tenu des charges d'ancrage. La position des chevilles (par exemple leur position par rapport aux armatures ou aux supports, dans du béton fissuré ou non fissuré, etc.) devra être indiquée avec précision sur les plans.
- Les ancrages sous charges statiques et quasi statiques sont conçus selon la méthode A de l'annexe C du guide ETAG 029

Pose :





- Pose par un personnel suffisamment qualifié, sous la surveillance du conducteur des travaux

Système Hilti HIT-HY 170

Usage prévu
Spécifications

Annexe B2

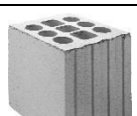
Tableau B2 : Types et propriétés des maçonneries

Type de maçonnerie	Image	Dimensions	Résistance à la compression [N/mm ²]	Masse volumique [kg/dm ³]	Annexes
Maçonnerie pleine en terre cuite EN 771-1		≥ 240x115x52	12	2,0	C3
Maçonnerie pleine en silico calcaire EN 771-2		≥ 240x115x113	12 / 28	2,0	C4
Maçonnerie creuse en terre cuite EN 771-1		300x240x238	12 / 20	1,4	C5
Maçonnerie creuse en silico calcaire EN 771-2		248x240x238	12 / 20	1,4	C6
Maçonnerie creuse en béton léger EN 771-3		495x240x238	2 / 6	0,8	C8
Maçonnerie creuse en béton normal EN 771-3		500x200x200	4 / 10	1,0	C8











Système Hilti HIT-HY 170

Usage prévu

Types et propriétés des maçonneries

Annexe B3

Tableau B3 : Eléments d'ancrage (y compris taille et profondeur d'implantation) et type de maçonneries correspondantes

Type de maçonnerie	Image	HIT-V ¹⁾ 	HIT-IC 	HIT-V ¹⁾ + HIT-SC 	HIT-IC + HIT-SC 	Annexe
Maçonnerie pleine en terre cuite EN 771-1		M8 à M12	M8 à M12	M8 à M12	M8 à M12	C3
Maçonnerie pleine en silico calcaire EN 771-2		M8 à M12	M8 à M12	M8 à M12	M8 à M12	C4
Maçonnerie creuse en terre cuite EN 771-1		-	-	M8 à M12	M8 à M12	C5
Maçonnerie creuse en silico calcaire EN 771-2		-	-	M8 à M12	M8 à M12	C6
Maçonnerie creuse en béton léger EN 771-3		-	-	M8 à M12	M8 à M12	C7
Maçonnerie creuse en béton normal EN 771-3		-	-	M8 à M12	M8 à M12	C8

1) Les tiges du commerce peuvent également être utilisées.

Système Hilti HIT-HY 170

Usage prévu

Eléments d'ancrage et types de maçonneries correspondantes

Annexe B4

Tableau B4 : Détails des maçonneries creuses

Maçonnerie creuse en terre cuite EN 771-1



Rapis Ziegel Hlz 12-1,4-10DF

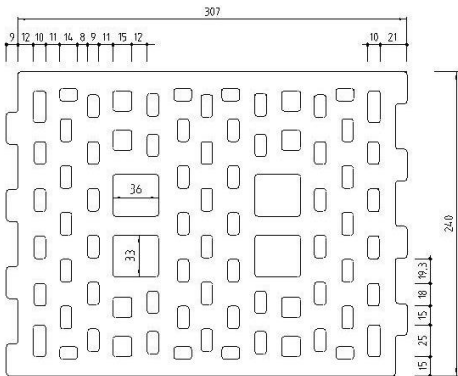

Maçonnerie creuse en silico-calcaire EN 771-2

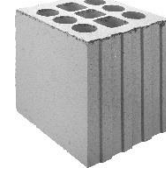

KS Wemding KSL-R(P) 12-1,4 8DF

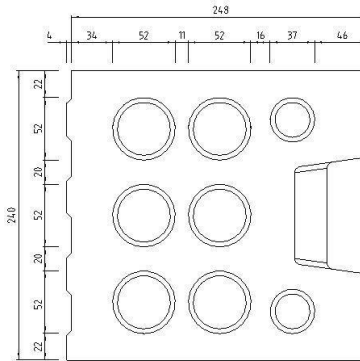

Maçonnerie creuse en béton léger EN 771-3



Knobel Betonwerk Hbl 6-0,8-500x240x238

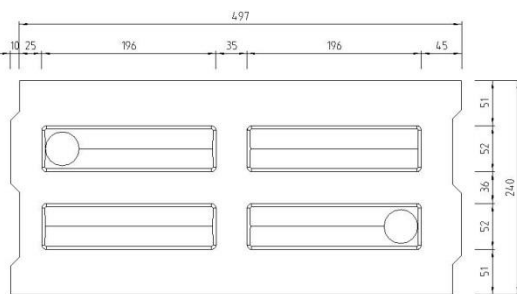

Maçonnerie creuse en béton normal EN 771-3



Parpaing creux B40

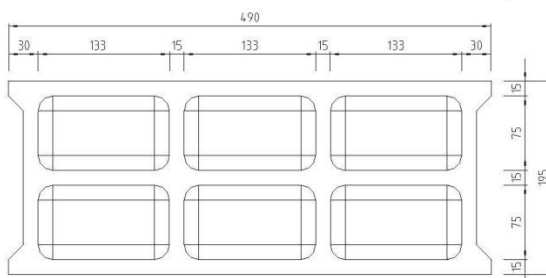

Système Hilti HIT-HY 170

Usage prévu

Détails des maçonneries creuses

Annexe B5

Tableau B5 : Données de pose pour tige HIT-V-... avec un tamis HIT-SC en maçonnerie pleine ou creuse (Figure A1)





HIT-V-...			M8	M10	M12
avec HIT-SC			16x85	16x85	18x85
Diamètre de perçage	d_0	[mm]	16	16	18
Profondeur de perçage	h_0	[mm]	95	95	95
Profondeur d'ancrage effective	h_{ef}	[mm]	80	80	80
Diamètre du trou de passage	d_f	[mm]	9	12	14
Epaisseur minimum du mur	h_{min}	[mm]	115	115	115
Ecouvillon HIT-RB	-	[-]	16	16	18
Couple de serrage maxi pour toute maçonnerie sauf parpaing creux	T_{max}	[Nm]	3	4	6
Couple de serrage maxi pour parpaing creux	T_{max}	[Nm]	2	2	3
Nombre de pression HDM	-	[-]	6	6	8
Nombre de pression HDE 500-A	-	[-]	5	5	6

Tableau B6 : Données de pose pour douille HIT-IC-... avec un tamis HIT-SC en maçonnerie pleine ou creuse (Figure A1)

HIT-IC...			M8x80	M10x80	M12x80
avec HIT-SC			16x85	18x85	22x85
Diamètre de perçage	d_0	[mm]	16	18	22
Profondeur de perçage	h_0	[mm]	95	95	95
Profondeur d'ancrage effective	h_{ef}	[mm]	80	80	80
Longueur de vissage	h_s	[mm]	8...75	10...75	12...75
Diamètre du trou de passage	d_f	[mm]	9	12	14
Epaisseur minimum du mur	h_{min}	[mm]	115	115	115
Ecouvillon HIT-RB	-	[-]	16	18	22
Couple de serrage maxi	T_{max}	[Nm]	3	4	6
Nombre de pression HDM	-	[-]	6	8	10
Nombre de pression HDE 500-A	-	[-]	5	6	8

Système Hilti HIT-HY 170

Usage prévu

Données de pose

Annexe B6

Tableau B7 : Données de pose pour tige HIT-V-... en maçonnerie pleine (Figure A)



HIT-V-...		M8	M10	M12
Diamètre de perçage	d_0 [mm]	10	12	14
Profondeur de perçage = Profondeur d'ancrage effective	$h_0 = h_{ef}$ [mm]	80	80	80
Diamètre du trou de passage	d_f [mm]	9	12	14
Epaisseur minimum du mur	h_{min} [mm]	115	115	115
Ecouvillon HIT-RB	- [-]	10	12	14
Couple de serrage maxi	T_{max} [Nm]	5	8	10

Tableau B8 : Données de pose pour douille HIT-IC... en maçonnerie pleine (Figure A)

HIT-IC...		M8x80	M10x80	M12x80
Diamètre de perçage	d_0 [mm]	14	16	18
Profondeur de perçage = Profondeur d'ancrage effective	$h_0 = h_{ef}$ [mm]	80	80	80
Longueur de vissage	h_s [mm]	8...75	10...75	12...75
Diamètre du trou de passage	d_f [mm]	9	12	14
Epaisseur minimum du mur	h_{min} [mm]	115	115	115
Ecouvillon HIT-RB	- [-]	14	16	18
Couple de serrage maxi	T_{max} [Nm]	5	8	10

Système Hilti HIT-HY 170

Usage prévu

Données de pose

Annexe B7

Tableau B9 : Temps de durcissement maximum et temps de séchage minimum pour maçonnerie pleine ¹⁾

Température dans le matériau de base T	Durée pratique d'utilisation maximum t_{work}	Temps de séchage minimum t_{cure}
5 °C à 10 °C	8 min	2,5 h
> 10 °C à 20 °C	5 min	1,5 h
> 20 °C à 30 °C	3 min	45 min
> 30 °C à 40 °C	2 min	30 min



¹⁾ Le temps de séchage est valide pour les matériaux de base secs uniquement. Pour les supports humides, ces temps doivent être doubles.

Tableau B10 : Temps de durcissement maximum et temps de séchage minimum pour maçonnerie creuse ¹⁾

Température dans le matériau de base T	Durée pratique d'utilisation maximum t_{work}	Temps de séchage minimum t_{cure}
-5 °C à 0 °C	10 min	12 h
> 0 °C à 5 °C	10 min	5 h
> 5 °C à 10 °C	8 min	2,5 h
> 10 °C à 20 °C	5 min	1,5 h
> 20 °C à 30 °C	3 min	45 min
> 30 °C à 40 °C	2 min	30 min

¹⁾ Le temps de séchage est valide pour les matériaux de base secs uniquement. Pour les supports humides, ces temps doivent être doubles.

Tableau B11 : Méthodes de nettoyage

<p>Nettoyage manuel (MC) : Pompe soufflante</p>	
<p>Nettoyage à air comprimé (CAC) : Pistolet à air comprimé recommandé avec une ouverture de l'orifice de diamètre 3,5 mm minimum</p>	
<p>Ecouvillons métalliques selon tableaux B5 à B8 selon le diamètre du trou pour nettoyage MC et CAC</p>	

Système Hilti HIT-HY 170

Usage prévu

Données de pose et outils de nettoyage

Annexe B8

Instructions de pose

Perçage du trou

Si une résistance significative n'est pas ressentie pendant la totalité du perçage (par ex. en joints bout à bout non remplis), il convient de ne pas poser la cheville à cette position.

Méthode de perçage

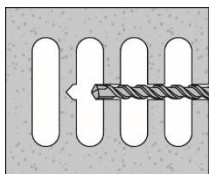

En maçonnerie creuse (catégorie d'utilisation c): Mode rotation

Percer le trou à la profondeur d'implantation requise en utilisant un marteau perforateur en mode rotation et une mèche de diamètre approprié.

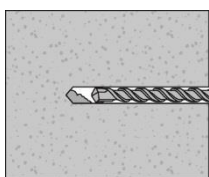

En maçonnerie pleine (catégorie d'utilisation b): Mode rotation-percussion

Percer le trou à la profondeur d'implantation requise en utilisant un marteau perforateur en rotation-percussion et une mèche de diamètre approprié.

Nettoyage du trou

Avant de poser la cheville, le trou doit être exempt de poussières et de débris

Nettoyage manuel (MC) pour maçonneries pleines et creuses

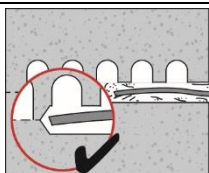

Soufflage 2 fois depuis le fond du trou sur toute la longueur du trou avec la pompe soufflante jusqu'à ce que l'air qui ressort soit exempt de poussière notable.

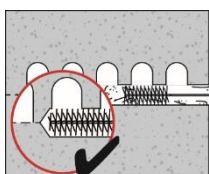

Brossage 2 fois avec l'écouvillon de taille spécifiée (voir tableaux B5 à B8) en insérant l'écouvillon métallique rond Hilti HIT-RB au fond du trou avec un mouvement tournant.

L'écouvillon doit présenter une résistance naturelle à l'entrée dans le trou (\varnothing écouvillon $\geq \varnothing$ trou). Si ce n'est pas le cas, utiliser un nouvel écouvillon ou un écouvillon de diamètre supérieur.

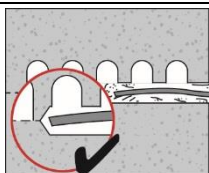

Soufflage à nouveau 2 fois avec la pompe soufflante ou avec de l'air comprimé jusqu'à ce que l'air qui ressort soit exempt de poussière notable.

Systeme Hilti HIT-HY 170

Usage prévu

Instruction de pose

Annexe B9

Préparation de l'injection en maçonnerie avec trous ou vides: pose avec tamis HIT-SC

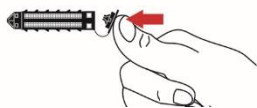

Tamis HIT-SC
 Fermer le couvercle

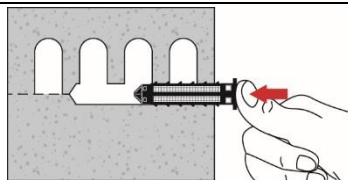

Insérer le tamis manuellement.

Pour toutes les applications

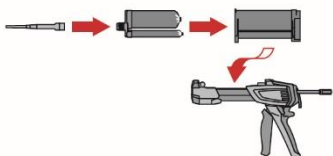

Fixer soigneusement la buse mélangeuse HIT-RE-M à la cartouche. Ne pas modifier la buse mélangeuse. Respecter le mode d'emploi de la pince à injecter. Vérifier le fonctionnement du porte-cartouche. Insérer la cartouche dans le porte cartouche. Ne jamais utiliser des cartouches endommagées et/ou des porte cartouches endommagés ou très sales. Tourner le porte cartouche avec la cartouche dedans dans la pince à injection

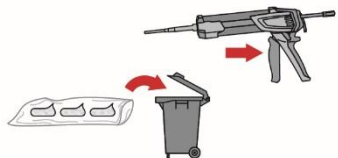

Jeter les premières pressions. La cartouche s'ouvre automatiquement lorsque l'injection commence. En fonction de la taille de la cartouche, les premières pressions doivent être jetées.
 Quantités à éliminer: 2 pressions pour cartouche 330 ml,
 3 pressions pour cartouche 500 ml

Injection de la résine depuis le fond du trou sans former de bulle d'air

Pose avec tamis HIT-SC

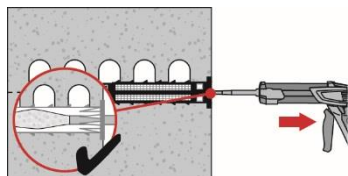

Tamis HIT-SC
 Insérer la buse d'environ 1 cm à travers le couvercle. Injecter la quantité de résine nécessaire (voir tableaux B5 et B6). La résine doit ressortir à travers le couvercle.

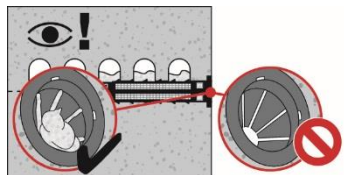

Contrôler la quantité de résine injectée. Elle doit dépasser du couvercle.
 Après l'injection, dépressuriser la pince en pressant le bouton de débrayage. Ceci permettra d'éviter de continuer à injecter la résine.

Système Hilti HIT-HY 170

Usage prévu
 Instruction de pose

Annexe B10

Maçonnerie pleine: pose sans tamis

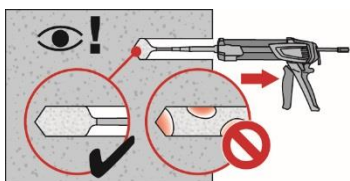

Injecter la résine à partir du fond du trou vers l'extrémité et retirer lentement et progressivement la buse mélangeuse après chaque pression.
 Remplir le trou jusqu'à peu près les 2/3, ou comme demandé pour assurer que l'espace annulaire entre la cheville et le béton soit complètement rempli sur toute la longueur d'implantation.
 Après l'injection, dépressuriser la pince en pressant le bouton de débrayage. Ceci permettra d'éviter de continuer à injecter la résine.

Pose de l'élément

Avant la pose, vérifier que l'élément est sec et exempt d'huile et autres contaminants.

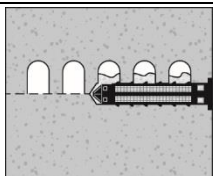

**HIT-V...ou HIT-IC en maçonnerie creuse ou pleine :
 Pose avant pièce à fixer (Figure A1 à Figure A)**

Marquer et insérer l'élément à la profondeur requise jusqu'à ce que la durée pratique d'utilisation t_{work} se soit écoulée. La durée pratique d'utilisation est donnée dans les tableaux B9 et B10.

Mise en charge de la cheville

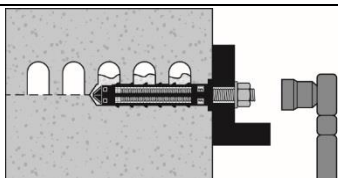

Mettre en charge la cheville :
 Après le temps de durcissement t_{cure} (voir tableaux B9 et B10) la cheville peut être mise en charge.
 Le couple de serrage appliqué ne doit pas excéder les valeurs données dans les tableaux B5 à B8.















Système Hilti HIT-HY 170

Usage prévu

Instruction de pose

Annexe B11

Tableau C1 : Coefficient β pour essais sur chantier en traction

Catégories d'utilisation		w/w et w/d		d/d	
Plage de température		Ta ¹⁾	Tb ¹⁾	Ta ¹⁾	Tb ¹⁾
Matériaux de base	Eléments				
Brique pleine en terre cuite EN 771-1	HIT-V ²⁾ ou HIT-IC 	0,97	0,83	0,97	0,83
	HIT-V ²⁾ + HIT-SC 				
	HIT-IC + HIT-SC 				
Brique pleine en silico calcaire EN 771-2	HIT-V ²⁾ ou HIT-IC 	0,96	0,84	0,97	0,84
	HIT-V ²⁾ + HIT-SC 	0,69	0,62	0,91	0,82
	HIT-IC + HIT-SC 				
Brique creuse en terre cuite EN 771-1	HIT-V ²⁾ + HIT-SC 	0,97	0,83	0,97	0,83
	HIT-IC + HIT-SC 				
Brique creuse en silico calcaire EN 771-2	HIT-V ²⁾ + HIT-SC 	0,69	0,62	0,91	0,82
	HIT-IC + HIT-SC 				
					
Maçonnerie creuse en béton léger EN 771-3	HIT-V ²⁾ + HIT-SC 	0,89	0,81	0,97	0,86
	HIT-IC + HIT-SC 				
Maçonnerie creuse en béton normal EN 771-3	HIT-V ²⁾ + HIT-SC 	0,97	0,80	0,97	0,80
	HIT-IC + HIT-SC 				

¹⁾ Plage de température Ta / Tb, voir annexe B1.

²⁾ Des tiges du commerce peuvent également être utilisées

Système Hilti HIT-HY 170

Performances

Coefficient β pour essais sur chantier en traction

Annexe C1

Tableau C2 : Résistances caractéristiques pour la résistance acier des tiges filetées sous charges de traction et cisaillement en maçonnerie

Rupture acier en traction		M8	M10	M12
Résistance caractéristique	$N_{Rk,s}$ [kN]	$A_s \cdot f_{uk}$		
Rupture acier en cisaillement sans bras de levier				
Résistance caractéristique	$V_{Rk,s}$ [kN]	$0,5 \cdot A_s \cdot f_{uk}$		
Rupture acier en cisaillement avec bras de levier				
Résistance caractéristique	$M_{Rk,s}$ [Nm]	$1,2 \cdot W_{el} \cdot f_{uk}$		

Tableau C3 : Résistances caractéristiques pour la résistance acier des douilles taraudées HIT-IC sous charges de traction et cisaillement en maçonnerie

Rupture acier en traction		M8	M10	M12
HIT-IC	$N_{Rk,s}$ [kN]	5,9	7,3	13,8
Coefficient partiel de sécurité	$\gamma_{Ms,N}$ [-]	1,5		
Rupture acier en cisaillement sans bras de levier				
HIT-V 5.8	$V_{Rk,s}$ [kN]	$0,5 \cdot A_s \cdot f_{uk}$		
Rupture acier en cisaillement avec bras de levier				
HIT-V 5.8	$M_{Rk,s}$ [Nm]	$1,2 \cdot W_{el} \cdot f_{uk}$		

Système Hilti HIT-HY 170

Performances

Résistance caractéristique en traction et cisaillement – rupture acier

Annexe C2

Type de maçonnerie : Maçonnerie pleine en terre cuite Mz, 2DF

Tableau C4 : Description de la maçonnerie

Type de maçonnerie		Pleine Mz, 2DF	
Masse volumique	ρ [kg/dm ³]	$\geq 2,0$	
Résistance à la compression	f_b [N/mm ²]	≥ 12	
Norme		EN 771 - 1	
Fabricant			
Dimensions	[mm]	$\geq 240 \times 115 \times 113$	
Epaisseur de mur minimum	h_{min} [mm]	≥ 115	





Tableau C5 : Données de pose pour toutes les combinaisons (voir tableau B3)

Type de cheville		Voir tableau B3
Distance au bord	$c_{min} = c_{cr}$ [mm]	115
Entraxe	$s_{min \parallel} = s_{cr \parallel}$ [mm]	240
	$s_{min \perp} = s_{cr \perp}$ [mm]	115

Tableau C6 : Coefficient de groupe pour les groupes de chevilles

Coefficient de groupe	$\alpha_{g,N \parallel} \alpha_{g,V \parallel} \alpha_{g,N \perp} \alpha_{g,V \perp} [-]$	2 à c_{cr} et s_{cr}
-----------------------	---	--------------------------

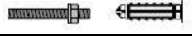
Tableau C7 : Résistance en traction à une distance au bord $c \geq c_{cr}$

Catégorie d'utilisation				w/w = w/d		d/d	
Plage de température				(Ta)	(Tb)	(Ta)	(Tb)
Type de cheville et taille	h_{ef} [mm]	f_b [N/mm ²]	N_{Rk} [kN]				
HIT-V ¹⁾  M8, M10, M12	80	12	3,0	2,5	3,0	2,5	
HIT-IC  M8	80	12	3,0	2,5	3,0	2,5	
			M10, M12	4,0	3,5	4,0	3,5
HIT-V ¹⁾ + HIT-SC  M8, M10, M12	80	12	4,0	3,5	4,0	3,5	
HIT-IC + HIT-SC  M8, M10, M12	80	12	4,0	3,5	4,0	3,5	

¹⁾ Des tiges du commerce peuvent également être utilisées

Tableau C8 : Résistance en cisaillement à une distance au bord $c \geq c_{cr}$

Catégorie d'utilisation				w/w = w/d		d/d	
Plage de température				Ta	Tb	Ta	Tb
Type de cheville et taille	h_{ef} [mm]	f_b [N/mm ²]	$V_{Rk,b}$ [kN]				
Toutes les chevilles	80	12	3,5				

¹⁾ Des tiges du commerce peuvent également être utilisées

Tableau C9 : Déplacements

h_{ef}	N	δ_{N0}	$\delta_{N\infty}$	V	δ_{V0}	$\delta_{V\infty}$
[mm]	[kN]	[mm]	[mm]	[kN]	[mm]	[mm]
80	0,9	0,2	0,4	1,0	1,0	1,5

Système Hilti HIT-HY 170

Performances maçonnerie pleine en terre cuite Mz, 2DF

Données de pose et coefficient de groupe
Résistances caractéristiques en traction et cisaillement - Déplacements

Annexe C3

Type de maçonnerie : Maçonnerie pleine en terre cuite KS, 2DF

Tableau C10 : Description de la maçonnerie

Type de maçonnerie		Pleine Mz, 2DF	
Masse volumique	ρ [kg/dm ³]	$\geq 2,0$	
Résistance à la compression	f_b [N/mm ²]	≥ 12 ou ≥ 28	
Norme		EN 771 – 2	
Fabricant			
Dimensions	[mm]	$\geq 240 \times 115 \times 113$	
Epaisseur de mur minimum	h_{min} [mm]	≥ 115	





Tableau C11 : Données de pose pour toutes les combinaisons (voir tableau B3)

Type de cheville		Voir tableau B3
Distance au bord	$c_{min} = c_{cr}$ [mm]	115
Entraxe	$s_{min \parallel} = s_{cr \parallel}$ [mm]	240
	$s_{min \perp} = s_{cr \perp}$ [mm]	115

Tableau C12 : Coefficient de groupe pour les groupes de chevilles

Coefficient de groupe	$\alpha_{g,N \parallel} \alpha_{g,V \parallel} \alpha_{g,N \perp} \alpha_{g,V \perp} [-]$	2 à c_{cr} et s_{cr}
-----------------------	---	--------------------------

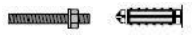
Tableau C13 : Résistance en traction à une distance au bord $c \geq c_{cr}$

Catégorie d'utilisation			w/w = w/d		d/d	
Plage de température			(Ta)	(Tb)	(Ta)	(Tb)
Type de cheville et taille	h_{ef} [mm]	f_b [N/mm ²]	N_{Rk} [kN]			
HIT-V ¹⁾  M8, M10, M12	80	12	5,5	5,0	6,0	5,0
HIT-IC 		28	8,5	7,5	8,5	7,5
HIT-V ¹⁾ + HIT-SC  M8, M10, M12	80	12	4,0	3,5	5,5	5,0
HIT-IC + HIT-SC 		28	6,0	5,5	8,0	7,5

¹⁾ Des tiges du commerce peuvent également être utilisées

Tableau C14 : Résistance en cisaillement à une distance au bord $c \geq c_{cr}$

Catégorie d'utilisation			w/w = w/d		d/d	
Plage de température			Ta	Tb	Ta	Tb
Type de cheville et taille	h_{ef} [mm]	f_b [N/mm ²]	$V_{Rk,b}$ [kN]			
Toutes les chevilles	M8, M10, M12	80	12	4,0		
			28	6,0		

Tableau C15 : Déplacements

h_{ef}	N	δ_{N0}	$\delta_{N\infty}$	V	δ_{V0}	$\delta_{V\infty}$
[mm]	[kN]	[mm]	[mm]	[kN]	[mm]	[mm]
80	2,3	0,2	0,4	1,5	1,2	1,8

Système Hilti HIT-HY 170

Performances maçonnerie pleine en silico calcaire KS, 2DF

Données de pose et coefficient de groupe
Résistances caractéristiques en traction et cisaillement - Déplacements

Annexe C4

Type de maçonnerie : Maçonnerie creuse en terre cuite Hz, 10DF

Tableau C16 : Description de la maçonnerie

Type de maçonnerie		Hz12-1,4 - 10DF	 <p>Dessin de la brique en tableau B4</p>
Masse volumique	ρ [kg/dm ³]	$\geq 1,4$	
Résistance à la compression	f_b [N/mm ²]	≥ 12 ou ≥ 20	
Norme		EN 771 - 1	
Fabricant		Rapis (D)	
Dimensions	[mm]	300 x 240 x 238	
Epaisseur de mur minimum	h_{min} [mm]	≥ 240	



Tableau C17 : Données de pose pour toutes les combinaisons (voir tableau B3)

Type de cheville		Voir tableau B3
Distance au bord	$c_{min} = c_{cr}$ [mm]	150
Entraxe	$s_{min \parallel} = s_{cr \parallel}$ [mm]	300
	$s_{min \perp} = s_{cr \perp}$ [mm]	240

Tableau C18 : Coefficient de groupe pour les groupes de chevilles



Coefficient de groupe	$\alpha_{g,N \parallel} \alpha_{g,V \parallel} \alpha_{g,N \perp} \alpha_{g,V \perp}$ [-]	2 à c_{cr} et s_{cr}
-----------------------	---	--------------------------

Tableau C19 : Résistance en traction à une distance au bord $c \geq c_{cr}$

Catégorie d'utilisation			w/w = w/d		d/d	
Plage de température			(Ta)	(Tb)	(Ta)	(Tb)
Type de cheville et taille	h_{ef} [mm]	f_b [N/mm ²]	N_{Rk} [kN]			
HIT-V ¹⁾ + HIT-SC  M8, M10, M12	80	12	3,0	2,5	3,0	2,5
HIT-IC + HIT-SC 		20	3,5	3,0	3,5	3,0

¹⁾ Des tiges du commerce peuvent également être utilisées

Tableau C20 : Résistance en cisaillement à une distance au bord $c \geq c_{cr}$

Catégorie d'utilisation			w/w = w/d		d/d	
Plage de température			(Ta)	(Tb)	(Ta)	(Tb)
Type de cheville et taille	h_{ef} [mm]	f_b [N/mm ²]	$V_{Rk,b}$ [kN]			
HIT-V ¹⁾ + HIT-SC  M8, M10, M12	80	12	2,0			
HIT-IC + HIT-SC 		20	3,0			

¹⁾ Des tiges du commerce peuvent également être utilisées

Tableau C21 : Déplacements

h_{ef}	N	δ_{N0}	$\delta_{N\infty}$	V	δ_{V0}	$\delta_{V\infty}$
[mm]	[kN]	[mm]	[mm]	[kN]	[mm]	[mm]
80	0,9	0,2	0,3	0,9	1,0	1,5

Système Hilti HIT-HY 170

Performances maçonnerie creuse en terre cuite Hz, 10DF

Données de pose et coefficient de groupe
Résistances caractéristiques en traction et cisaillement - Déplacements

Annexe C5

Type de maçonnerie : Maçonnerie creuse silico-calcaire KSL, 8DF

Tableau C22 : Description de la maçonnerie

Type de maçonnerie		KSL-12-1,4 - 8DF	 Dessin de la brique en tableau B4
Masse volumique	ρ [kg/dm ³]	$\geq 1,4$	
Résistance à la compression	f_b [N/mm ²]	≥ 12 ou ≥ 20	
Norme		EN 771 - 2	
Fabricant		KS Wemding (D)	
Dimensions	[mm]	248 x 240 x 238	
Epaisseur de mur minimum	h_{min} [mm]	≥ 240	



Tableau C23 : Données de pose pour toutes les combinaisons (voir tableau B3)

Type de cheville		Voir tableau B3
Distance au bord	$c_{min} = c_{cr}$ [mm]	125
Entraxe	$s_{min II} = s_{cr II}$ [mm]	248
	$s_{min \perp} = s_{cr \perp}$ [mm]	240

Tableau C24 : Coefficient de groupe pour les groupes de chevilles

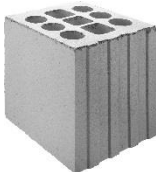

Coefficient de groupe	$\alpha_{g,N II} \alpha_{g,V II} \alpha_{g,N \perp} \alpha_{g,V \perp} [-]$	2 à c_{cr} et s_{cr}
-----------------------	---	--------------------------

Tableau C25 : Résistance en traction à une distance au bord $c \geq c_{cr}$

Catégorie d'utilisation			w/w = w/d		d/d	
Plage de température			(Ta)	(Tb)	(Ta)	(Tb)
Type de cheville et taille	h_{ef} [mm]	f_b [N/mm ²]	N_{Rk} [kN]			
HIT-V ¹⁾ + HIT-SC  M8, M10, M12	80	12	3,0	2,5	3,0	2,5
HIT-IC + HIT-SC 		20	4,0	3,5	5,0	4,5

¹⁾ Des tiges du commerce peuvent également être utilisées

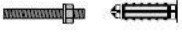
Tableau C26 : Résistance en cisaillement à une distance au bord $c \geq c_{cr}$

Catégorie d'utilisation			w/w = w/d		d/d	
Plage de température			(Ta)	(Tb)	(Ta)	(Tb)
Type de cheville et taille	h_{ef} [mm]	f_b [N/mm ²]	$V_{Rk,b}$ [kN]			
HIT-V ¹⁾ + HIT-SC  M8, M10, M12	80	12	8,5			
HIT-IC + HIT-SC 		20	12,0			

¹⁾ Des tiges du commerce peuvent également être utilisées

Tableau C27 : Déplacements

h_{ef}	N	δ_{N0}	$\delta_{N\infty}$	V	δ_{V0}	$\delta_{V\infty}$
[mm]	[kN]	[mm]	[mm]	[kN]	[mm]	[mm]
80	1,8	0,2	0,3	3,4	2,5	3,8

Système Hilti HIT-HY 170

Performances maçonnerie creuse silico-calcaire KSL, 8DF

Données de pose et coefficient de groupe
Résistances caractéristiques en traction et cisaillement - Déplacements

Annexe C6

Type de maçonnerie: Maçonnerie creuse en béton léger Hbl, 16DF

Tableau C28 : Description de la maçonnerie

Type de maçonnerie		Hbl-4- 0,7	 <p>Dessin de la brique en tableau B4</p>
Masse volumique	ρ [kg/dm ³]	$\geq 0,8$	
Résistance à la compression	f_b [N/mm ²]	≥ 2 ou ≥ 6	
Norme		EN 771 – 3	
Fabricant		Knobel (D)	
Dimensions	[mm]	495 x 240 x 238	
Epaisseur de mur minimum	h_{min} [mm]	≥ 240	



Tableau C29 : Données de pose pour toutes les combinaisons (voir tableau B3)

Type de cheville		Voir tableau B3
Distance au bord	$c_{min} = c_{cr}$ [mm]	250
Entraxe	$s_{min \parallel} = s_{cr \parallel}$ [mm]	240
	$s_{min \perp} = s_{cr \perp}$ [mm]	240

Tableau C30 : Coefficient de groupe pour les groupes de chevilles



Coefficient de groupe	$\alpha_{g,N} \parallel \alpha_{g,V} \parallel \alpha_{g,N} \perp \alpha_{g,V} \perp [-]$	2 à c_{cr} et s_{cr}
-----------------------	---	--------------------------

Tableau C31 : Résistance en traction à une distance au bord $c \geq c_{cr}$

Catégorie d'utilisation			w/w = w/d		d/d	
Plage de température			(Ta)	(Tb)	(Ta)	(Tb)
Type de cheville et taille	h_{ef} [mm]	f_b [N/mm ²]	N_{Rk} [kN]			
HIT-V ¹⁾ + HIT-SC  M8, M10, M12	80	2	1,2	0,9	1,5	1,2
HIT-IC + HIT-SC 		6	2,0	1,5	2,5	2,0

¹⁾ Des tiges du commerce peuvent également être utilisées

Tableau C32 : Résistance en cisaillement à une distance au bord $c \geq c_{cr}$

Catégorie d'utilisation			w/w = w/d		d/d	
Plage de température			(Ta)	(Tb)	(Ta)	(Tb)
Type de cheville et taille	h_{ef} [mm]	f_b [N/mm ²]	$V_{Rk,b}$ [kN]			
HIT-V ¹⁾ + HIT-SC  M8, M10, M12	80	12	2,5			
HIT-IC + HIT-SC 		20	4,0			

¹⁾ Des tiges du commerce peuvent également être utilisées

Tableau C33 : Déplacements

h_{ef}	N	δ_{N0}	$\delta_{N\infty}$	V	δ_{V0}	$\delta_{V\infty}$
[mm]	[kN]	[mm]	[mm]	[kN]	[mm]	[mm]
80	2,4	0,2	0,4	3,4	1,3	1,9

Système Hilti HIT-HY 170

Performances maçonnerie creuse en béton léger Hbl 16DF

Données de pose et coefficient de groupe
Résistances caractéristiques en traction et cisaillement - Déplacements

Annexe C7

Type de maçonnerie : Maçonnerie creuse en béton normal, parpaing creux

Tableau C34 : Description de la maçonnerie

Type de maçonnerie		B40	 <p>Dessin de la brique en tableau B4</p>
Masse volumique	ρ [kg/dm ³]	$\geq 1,0$	
Résistance à la compression	f_b [N/mm ²]	≥ 4 ou ≥ 10	
Norme		EN 771 – 3	
Fabricant		Fabemi (F)	
Dimensions	[mm]	500 x 200 x 200	
Epaisseur de mur minimum	h_{min} [mm]	≥ 200	



Tableau C35 : Données de pose pour toutes les combinaisons (voir tableau B3)

Type de cheville		Voir tableau B3
Distance au bord	$c_{min} = c_{cr}$ [mm]	200
Entraxe	$s_{min \parallel} = s_{cr \parallel}$ [mm]	200
	$s_{min \perp} = s_{cr \perp}$ [mm]	200

Tableau C36 : Coefficient de groupe pour les groupes de chevilles



Coefficient de groupe	$\alpha_{g,N \parallel} \alpha_{g,V \parallel} \alpha_{g,N \perp} \alpha_{g,V \perp}$ [-]	2 à c_{cr} et s_{cr}
-----------------------	---	--------------------------

Tableau C37 : Résistance en traction à une distance au bord $c \geq c_{cr}$

Catégorie d'utilisation			w/w = w/d		d/d	
			(Ta)	(Tb)	(Ta)	(Tb)
Plage de température			(Ta)	(Tb)	(Ta)	(Tb)
Type de cheville et taille	h_{ef} [mm]	f_b [N/mm ²]	N_{Rk} [kN]			
HIT-V ¹⁾ + HIT-SC  M8, M10, M12	80	4	0,9	0,9	0,9	0,9
HIT-IC + HIT-SC 		10	1,2	1,2	1,5	1,5

¹⁾ Des tiges du commerce peuvent également être utilisées

Tableau C38 : Résistance en cisaillement à une distance au bord $c \geq c_{cr}$

Catégorie d'utilisation			w/w = w/d		d/d	
			(Ta)	(Tb)	(Ta)	(Tb)
Plage de température			(Ta)	(Tb)	(Ta)	(Tb)
Type de cheville et taille	h_{ef} [mm]	f_b [N/mm ²]	$V_{Rk,b}$ [kN]			
HIT-V ¹⁾ + HIT-SC  M8, M10, M12	80	4	2,5			
HIT-IC + HIT-SC 		10	4,0			

¹⁾ Des tiges du commerce peuvent également être utilisées

Tableau C39 : Déplacements

h_{ef}	N	δ_{N0}	$\delta_{N\infty}$	V	δ_{V0}	$\delta_{V\infty}$
[mm]	[kN]	[mm]	[mm]	[kN]	[mm]	[mm]
80	1,0	0,6	1,2	2,3	0,6	0,9

Système Hilti HIT-HY 170

Performances maçonnerie creuse en béton normal, parpaing creux

Données de pose et coefficient de groupe
Résistances caractéristiques en traction et cisaillement - Déplacements

Annexe C8

mgr Marek Kądzieski
Tłumacz przysięgły języka angielskiego
Sworn translator and interpreter of English
01-167 Warszawa, ul. Zawiszy 16A m. 59
Tel. (22) 888-25-95
Mobile: (+48) 603 742 411
e-mail: biuro@areadicta.com.pl
www.areadicta.com.pl

Członek EOTA
www.eota.eu

Jednostka autoryzowana
na podstawie art. 29
Rozporządzenia (UE)
nr 305/2011 oraz członek
Europejskiej Organizacji
ds. Oceny Technicznej (EOTA)

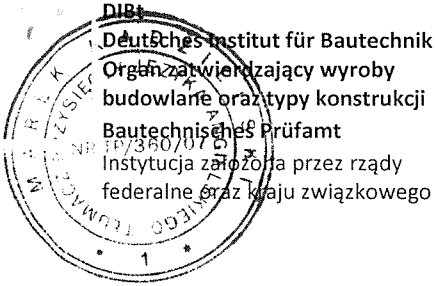

Uwierzytelnione tłumaczenie z języka angielskiego:-----

Europejska Ocena Techniczna

ETA-15/0197
z dnia 9 grudnia 2015 r.

Tłumaczenie na język angielski opracowane przez Niemiecki Instytut Techniki Budowlanej (DIBt) - wersja oryginalna w języku niemieckim.

Tłumaczenie z języka angielskiego na język polski wykonano na zlecenie Hilti

Część ogólna

Jednostka Oceny Technicznej wydająca Europejską Ocenę Techniczną:	Deutsches Institut für Bautechnik
Nazwa handlowa wyrobu budowlanego	System iniekcyjny Hilti HIT-HY 170
Rodzina wyrobów, do której wyrób budowlany należy	System iniekcyjny do konstrukcji murowych
Producent	Hilti AG Feldkircherstraße 100 9494 Schaan FÜRSTENTUM LIECHTENSTEIN
Zakład produkcyjny	Hilti Werke
Niniejsza Europejska Ocena Techniczna zawiera	26 stron, w tym 3 załączniki stanowiące integralną część oceny technicznej.
Niniejsza Europejska Ocena Techniczna została wydana zgodnie z Rozporządzeniem (UE) nr 305/2011 na podstawie	wytycznych dotyczących Europejskiej Aprobataj Technicznej dla „Kotew wklejanych do konstrukcji murowych”, ETAG 029, z kwietnia 2013 r., stosowanych jako Europejski Dokument Oceny według art. 66 par. 3 Rozporządzenia (UE) Nr 305/2011.
Niniejsza wersja zastępuje	ETA-15/0197 wydaną dnia 28 kwietnia 2015 r.



Europejska Ocena Techniczna
ETA-15/0197

Tłumaczenie na język angielski opracowane przez DIBt
Tłumaczenie z języka angielskiego na język polski wykonane na zlecenie Hilti

Strona 2 z 26 | 9 grudnia 2015 r.

Niniejsza Europejska Ocena Techniczna została wydana przez Jednostkę Oceny Technicznej w języku urzędowym tej jednostki. Tłumaczenia niniejszej Europejskiej Oceny Technicznej na inne języki powinny w pełni odpowiadać oryginalnie wydanemu dokumentowi i powinny być oznaczone jako tłumaczenia.

Niniejsza Europejska Ocena Techniczna, włączając w to jej formy elektroniczne, może być rozpowszechniana wyłącznie w całości. Jakkolwiek publikowanie części dokumentu jest możliwe wyłącznie za pisemną zgodą Jednostki Oceny Technicznej. W tym przypadku na kopii powinna być podana informacja, że jest to fragment dokumentu.

Niniejsza Europejska Ocena Techniczna może zostać wycofana przez wydającą ją Jednostkę Oceny Technicznej, w szczególności na podstawie informacji Komisji zgodnie z Artykułem 25(3) Rozporządzenia (UE) nr 305/2011.

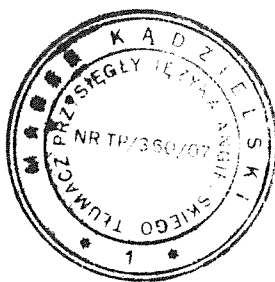

1 Opis techniczny wyrobu

System iniekcyjny Hilti HIT-HY170 do konstrukcji murowych stanowi kotwę wklejaną obejmującą opakowanie foliowe z żywicą iniekcyjną HIT-HY 170, tuleję siatkową oraz pręt kotwiący z nakrętką sześciokątną oraz podkładką w rozmiarach od M8 do M12 lub tuleję z gwintem wewnętrznym w rozmiarach od M8 do M12. Elementy stalowe są wykonane ze stali cynkowanej, stali nierdzewnej lub stali o wysokiej odporności na korozję.

Pręt kotwiący jest umieszczany w nawiercanym otworze wypełnionym żywicą iniekcyjną oraz kotwiony przez wiązanie chemiczne pomiędzy elementem stalowym, żywicą iniekcyjną oraz betonem.

Opis wyrobu został podany w załączniku A.

2 Określenie zamierzonego zastosowania, zgodnie z odpowiednim Europejskim Dokumentem Oceny (EDO)

Właściwości użytkowe podane w punkcie 3 obowiązują wyłącznie w przypadku, gdy stosowana jest kotwa zgodna ze specyfikacjami i warunkami podanymi w załączniku B.

Weryfikacja i metody oceny, na których oparta jest niniejsza Europejska Ocena Techniczna zakładają okres użytkowania kotwy wynoszący co najmniej 50 lat. Dane dotyczące okresu użytkowania wyrobu nie stanowią gwarancji udzielanej przez producenta, natomiast stanowią wyłącznie pomoc w doborze odpowiedniego wyrobu w zależności od ekonomicznie uzasadnionego okresu użytkowania danej konstrukcji.

3 Właściwości użytkowe wyrobu oraz metody zastosowane do ich oceny

3.1 Nośność i stateczność (podstawowe wymagania 1)

Zasadnicze charakterystyki	Właściwości użytkowe
Nośność charakterystyczna elementów stalowych	Patrz załącznik C2
Nośność charakterystyczna kotew w elementach murowych	Patrz załącznik C3 - C8
Przemieszczenia pod obciążeniem ścinającym i wyciągającym	Patrz załącznik C3 - C8
Współczynnik zmniejszający dla prób na miejscu (współczynnik β)	Patrz załącznik C1
Odległości od krawędzi oraz rozstaw	Patrz załącznik C3 - C8
Współczynnik grupowy dla mocowań grupowych	Patrz załącznik C3 - C8

3.2 Bezpieczeństwo pożarowe (podstawowe wymagania 2)

Zasadnicze charakterystyki	Właściwości użytkowe
Reakcja na ogień	Klasa A1
Odporność ogniowa	Nie oceniano właściwości użytkowych w tym zakresie

3.3 Higiena, zdrowie i środowisko (podstawowe wymagania 3)

Poza szczególnymi artykułami dotyczącymi substancji niebezpiecznych podanymi w niniejszej Europejskiej Ocenie Technicznej, mogą obowiązywać inne wymagania dotyczące wyrobu w tym zakresie (np. prawodawstwo europejskie i prawo krajowe, przepisy i postanowienia administracyjne). W celu spełnienia wymagań rozporządzenia (UE) nr 305/2011, należy zapewnić zgodność z obowiązującymi wymaganiami.

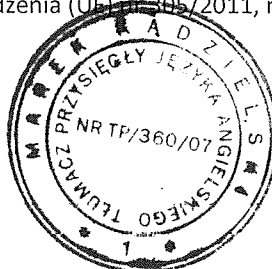

3.4 Bezpieczeństwo użytkowania (podstawowe wymagania 4)

Zasadnicze charakterystyki dotyczące bezpieczeństwa użytkowania zostały podane w Podstawowych wymaganiach dla prac budowlanych - Nośność i stateczność.

4 System oceny i weryfikacji stałości właściwości użytkowych (AVCP) wraz z odniesieniem do jego podstawy prawnej

Zgodnie z wytycznymi Europejskiej Oceny Technicznej ETAG 029, kwiecień 2013 stosowanej jako Europejski Dokument Oceny (EDO) według art. 66, par. 3 rozporządzenia (UE) nr 305/2011, właściwe rozporządzenie europejskie to: [97/177/WE].

Stosowane systemy: 1

5 Szczegóły techniczne niezbędne do wdrożenia systemu AVCP, zgodnie z właściwym Europejskim Dokumentem Oceny (EDO)

Szczegóły techniczne niezbędne do wdrożenia systemu AVCP zostały określone w planie kontroli złożonym w Deutsches Institut für Bautechnik.

Dokument wydany w Berlinie dnia 9 grudnia 2015 r. przez Deutsches Institut für Bautechnik.

Uwe Bender
Kierownik Działu

beglaubigt:
Wittstock



Warunki montażu

Rys. A1: Pustaki oraz cegły pełne z prętem gwintowanym HIT-V-... oraz tuleją siatkową HIT-SC (patrz tabela B5) lub z tuleją z gwintem wewnętrznym HIT-IC oraz tuleją siatkową HIT-SC (patrz tabela B6)

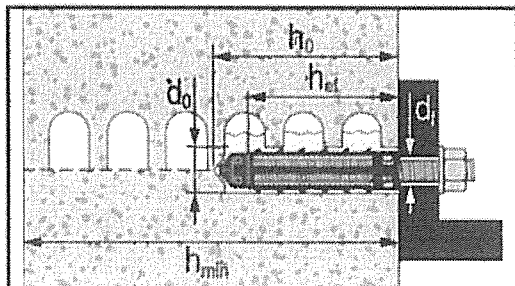

Rys. A2: Cegła pełna z prętem gwintowanym HIT-V-... (patrz tabela B7)

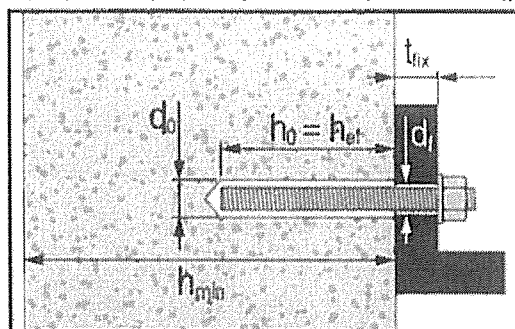

Rys. A3: Cegła pełna z tuleją z gwintem wewnętrznym HIT-IC (patrz tabela B8)

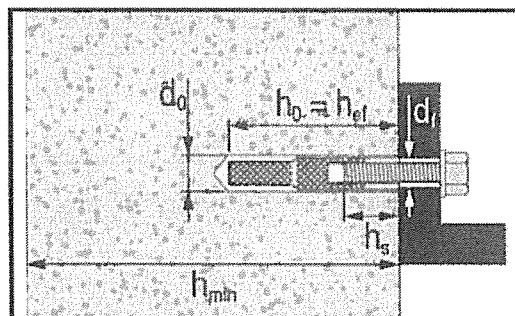

Hilti HIT-HY 170

Opis wyrobu
Warunki montażu.

Załącznik A1

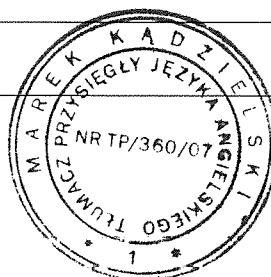

Opis wyrobu: Żywica iniekcyjna oraz elementy stalowe

Żywica iniekcyjna Hilti HIT-HY 170: system hybrydowy z dodatkiem kruszywa
330 ml oraz 500 ml

Oznaczenie:
HILTI HIT
Numer produkcyjny oraz linia
produkcyjna
Data przydatności mm/rrrr

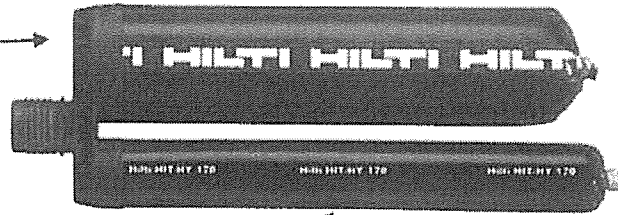

Nazwa wyrobu: „Hilti HIT-HY 170”

Mieszacz statyczny Hilti HIT-RE-M



Pręt gwintowany, HIT-V-...: M8 do M12



Standardowe dostępne na rynku pręty gwintowane:

- Materiały i właściwości mechaniczne według tabeli A1.
- Świadectwo odbioru 3.1 według EN 10204:2004. Dokumenty należy przechowywać do wglądu.
- Znacznik głębokości zakotwienia

Tuleja z gwintem wewnętrznym: HIT-IC M8 do M12

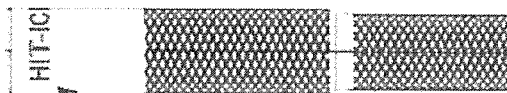

Oznaczenie:
np. HIT-IC M8x80

Tuleja siatkowa: HIT-SC 16 do 22

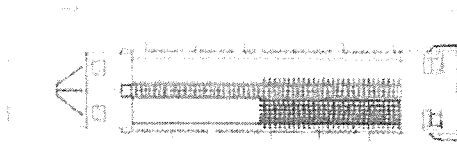

Cecha:
np. HIT-SC 18x85

Hilti HIT-HY 170

Opis wyrobu

Żywica iniekcyjna / Mieszacz statyczny / Elementy stalowe Tuleja siatkowa

Załącznik A2



Tabela A1: Materiały	
Oznaczenie	Materiał
Części metalowe ze stali ocynkowanej	
Pręt gwintowany HIT-V-5.8(F)	Klasa wytrzymałości 5.8, $f_{uk} = 500 \text{ N/mm}^2$, $f_{yk} = 400 \text{ N/mm}^2$. Wydłużenie przy zerwaniu ($l_0 = 5d$) >8% ciągliwości. Cynkowany galwanicznie $\geq 5\mu\text{m}$, (F) Cynkowany ogniowo $\geq 45 \mu\text{m}$.
Pręt gwintowany HIT-V-8.8(F)	Klasa wytrzymałości 8.8, $f_{uk} = 800 \text{ N/mm}^2$, $f_{yk} = 640 \text{ N/mm}^2$. Wydłużenie przy zerwaniu ($l_0 = 5d$) >8% ciągliwości. Cynkowany galwanicznie $\geq 5\mu\text{m}$, (F) Cynkowany ogniowo $\geq 45 \mu\text{m}$.
Tuleja z gwintem wewnętrzny HIS-IC	$f_{uk} = 490 \text{ N/mm}^2$, $f_{yk} = 390 \text{ N/mm}^2$. Wydłużenie przy zerwaniu ($l_0 = 5d$) > 8% ciągliwości. Cynkowana galwanicznie $\geq 5\mu\text{m}$
Podkładka	Cynkowana galwanicznie $\geq 5\mu\text{m}$ Cynkowana ogniowo $\geq 45 \mu\text{m}$
Nakrętka	Klasa wytrzymałości nakrętki dostosowana do klasy wytrzymałości pręta gwintowanego. Cynkowana galwanicznie $\geq 5\mu\text{m}$, (F) Cynkowana ogniowo $\geq 45 \mu\text{m}$.
Elementy metalowe ze stali nierdzewnej	
Pręt gwintowany HIT-V-R	Klasa wytrzymałości 70, $f_{uk} = 700 \text{ N/mm}^2$, $f_{yk} = 450 \text{ N/mm}^2$. Wydłużenie przy zerwaniu ($l_0 = 5d$) > 8% ciągliwości. Stal nierdzewna 1.4401, 1.4404, 1.4578, 1.4571, 1.4439, 1.4362 EN 10088-1:2014.
Podkładka	Stal nierdzewna 1.4401, 1.4404, 1.4578, 1.4571, 1.4439, 1.4362 EN 10088-1:2014.
Nakrętka	Klasa wytrzymałości nakrętki dostosowana do klasy wytrzymałości pręta gwintowanego Stal nierdzewna 1.4401, 1.4404, 1.4578, 1.4571, 1.4439, 1.4362 EN 10088-1:2014.
Elementy metalowe ze stali o wysokiej odporności na korozję	
Pręt gwintowany HIT-V-HCR	$f_{uk} = 800 \text{ N/mm}^2$, $f_{yk} = 640 \text{ N/mm}^2$. Wydłużenie przy zerwaniu ($l_0 = 5d$) > 8% ciągliwości. Stal o wysokiej odporności na korozję 1.4529, 1.4565 EN 10088-1:2014.
Podkładka	Stal o wysokiej odporności na korozję 1.4529, 1.4565 EN 10088-1:2014.
Nakrętka	Klasa wytrzymałości nakrętki dostosowana do klasy wytrzymałości pręta gwintowanego. Stal o wysokiej odporności na korozję 1.4529, 1.4565 EN 10088-1:2014.
Części z tworzywa sztucznego	
Tuleja siatkowa HIT-SC	Konstrukcja: FPP 20T. Siatka: PA6.6 N500/200.
Hilti HIT-HY 170	
Opis wyrobu Materiały	Załącznik A3



Wymagania techniczne zamierzonego zastosowania

Materiały podłoża:

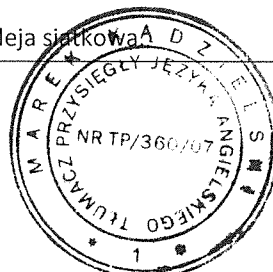
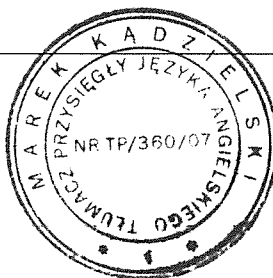
- Konstrukcja murowa z cegły pełnej (kategoria zastosowania b) według załącznika B3.
Uwaga: Nośność charakterystyczna dotyczy większych cegieł oraz wyższych wytrzymałości na ściskanie elementów murowych.
- Konstrukcja murowa z pustaka (kategoria zastosowania c) według załącznika B3 oraz B5.
- Marka zaprawy dla konstrukcji murowej: co najmniej M2.5 według EN 998-2:2010.
- W przypadku konstrukcji murowych wykonanych z cegły pełnej, pustaka lub cegły drążonej, nośność charakterystyczna kotwy może być wyznaczona na podstawie prób na miejscu montażu według ETAG 029, załącznik B z uwzględnieniem współczynnika β podanego w załączniku C1, tabela C1.

Tabela B1: Przegląd kategorii zastosowania

Zakotwienia podlegają:	HIT-HY 170 z prętem gwintowanym, HIT-V-... lub HIT-IC	
	w ceglach pełnych	w pustakach
Wiercenie otworów 	tryb udarowy	tryb obrotowy
Obciążeniom statycznym i quasi-statycznym	Załącznik: C2 (stal), C3, C4	Załącznik: C2 (stal), C5, C6, C7, C8
Kategoria zastosowania: konstrukcja sucha lub mokra	Kategoria d/d - Montaż i zastosowanie w konstrukcjach pracujących w suchych warunkach wewnętrznych. Kategoria w/d - Montaż w suchych lub mokrych podłożach oraz zastosowanie w konstrukcjach pracujących w suchych warunkach wewnętrznych. Kategoria w/w - Montaż i zastosowanie w konstrukcjach pracujących w suchych lub mokrych warunkach zewnętrznych.	
Kierunek montażu	poziomy	
Kategoria zastosowania	b (konstrukcja murowa z cegły pełnej)	c (konstrukcja murowa z pustaka lub cegły drążonej)
Temperatura materiału podłoża przy montażu:	od +5°C do +40°C (tabela B9)	od -5 °C do +40 °C (tabela B10)
Temperatura eksploatacji	Zakres temperatury Ta: od -40 °C do +40 °C	(maks. temperatura przy oddziaływaniu długotrwałym +24°C oraz maks. temperatura przy oddziaływaniu krótkotrwałym +40°C)
	Zakres temperatury Tb: od -40 °C do +80 °C	(maks. temperatura przy oddziaływaniu długotrwałym +50°C oraz maks. temperatura przy oddziaływaniu krótkotrwałym +80°C)

Hilti HIT-HY 170

Zamierzone zastosowanie
Specyfikacje.

Załącznik B1

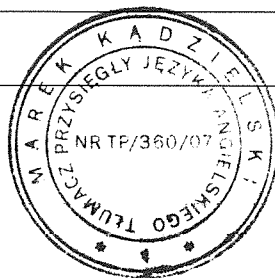

Warunki użycia (warunki środowiskowe):

- Konstrukcje pracujące w suchych warunkach wewnętrznych (stal cynkowana, stal nierdzewna lub stal o wysokiej odporności na korozję).
- Konstrukcje narażone na czynniki atmosferyczne (środowisko przemysłowe i morskie) oraz narażone na ciągły kontakt z wilgocią, jeśli nie występują szczególnie agresywne warunki (stal nierdzewna lub stal o wysokiej odporności na korozję).
- Konstrukcje narażone na czynniki atmosferyczne oraz ciągły kontakt z wilgocią, jeśli nie występują szczególnie agresywne warunki (stal o wysokiej odporności na korozję).
Uwaga: Szczególnie agresywne warunki obejmują na przykład: ciągłe lub okresowe zanurzenie w wodzie morskiej lub praca w strefie rozpryskiwania wody morskiej, atmosferę zawierającą chlorki w basenach krytych lub atmosferę silnie zanieczyszczoną chemicznie (np. zakłady odsiarczania lub tunele drogowe, w których stosowane są środki do odładzania nawierzchni).

Projektowanie:

- Zakotwienia powinny być projektowane pod nadzorem inżyniera doświadczonego w zakresie zakotwień oraz robót murarskich.
- Obliczenia oraz schematy powinny być wykonywane z możliwością weryfikacji oraz z uwzględnieniem przenoszonych obciążeń. Położenie kotwy powinno być wskazane na rysunkach wykonawczych (np. położenie kotwy względem wsporników).
- Projektowanie kotew powinno być wykonane dla warunków obciążenia statycznego lub quasi-statycznego według:
ETAG 029, załącznik C, metoda projektowania A.

Montaż:

- Montaż kotew powinien być wykonywany przez osoby wykwalifikowane pod nadzorem osoby odpowiedzialnej za kwestie techniczne na terenie budowy.

Hilti HIT-HY 170

Zamierzone zastosowanie
Specyfikacje.

Załącznik B2

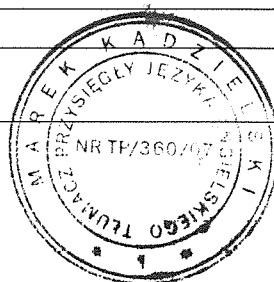

Tłumaczenie na język angielski opracowane przez DIBt
Tłumaczenie z języka angielskiego na język polski wykonane na zlecenie Hilti

Tabela B2: Zestawienie typów i właściwości cegieł

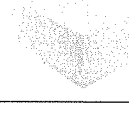
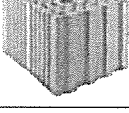
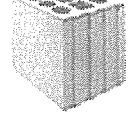
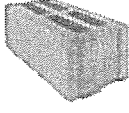
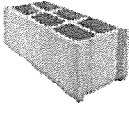
Typ cegły	Ilustracja	Rozmiar cegły [mm]	Nośność na ściskanie [N/mm ²]	Gęstość objętościowa [kg/dm ³]	Załącznik
Cegła ceramiczna pełna EN 771-1		≥ 240x115x113	12	2,0	C3
Cegła silikatowa pełna EN 771-2		≥ 240x115x113	12 / 28	2,0	C4
Pustak ceramiczny EN 771-1		300x240x238	12 / 20	1,4	C5
Pustak silikatowy EN 771-2		248x240x238	12 / 20	1,4	C6
Pustak z betonu lekkiego EN 771-3		495x240x238	2 / 6	0,8	C7
Pustak z betonu standardowego EN 771-3		500x200x200	4 / 10	1,0	C8







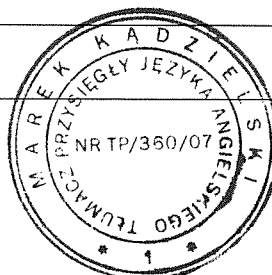

Hilti HIT-HY 170

Zamierzone zastosowanie
Typy i właściwości cegieł.

Załącznik B3

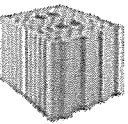
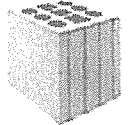
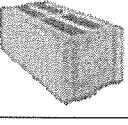

**Tabela B3: Zestawienie elementów mocujących (wraz z wymiarami) oraz odpowiadających im typów cegieł.
Głębokość osadzania $h_{ef} = 80$ mm**

Typ cegły	Ilustracja	HIT-V ¹⁾	HIT-IC	HIT-V ¹⁾ + HIT-SC	HIT-IC + HIT-SC	Załącznik
						
Cegła ceramiczna pełna EN 771-1		M8 do M12	M8 do M12	M8 do M12	M8 do M12	C3
Cegła silikatowa pełna EN 771-2		M8 do M12	M8 do M12	M8 do M12	M8 do M12	C4
Pustak ceramiczny EN 771-1		-	-	M8 do M12	M8 do M12	C5
Pustak silikatowy EN 771-2		-	-	M8 do M12	M8 do M12	C6
Pustak z betonu lekkiego EN 771-3		-	-	M8 do M12	M8 do M12	C7
Pustak z betonu standardowego EN 771-3		-	-	M8 do M12	M8 do M12	C8

¹⁾ Mogą być stosowane standardowe pręty gwintowane dostępne na rynku.

Hilti HIT-HY 170

Zamierzone zastosowanie
Elementy mocujące oraz odpowiadające im typy cegieł.

Załącznik B4



Tabela B4: Parametry pustaków

<p>Pustak ceramiczny EN 771-1</p> <p>Rapis Ziegel Hz 12-1,4-10DF</p>  	<p>Pustak silikatowy EN 771-2</p> <p>KS Südbayern KSL-R(P) 12-1,4-8DF</p>  
<p>Pustak z betonu lekkiego EN 771-3</p> <p>Knobel Betonwerk Hbl 6-0,8-500x240x238</p>  	<p>Pustak z betonu standardowego EN 771-3</p> <p>Parpaing creux B40</p>  

Hilti HIT-HY 170
Zamierzone zastosowanie
Parametry pustaków.

Załącznik B5

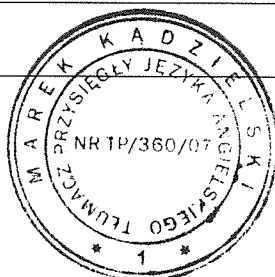
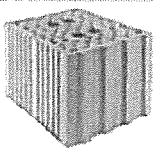
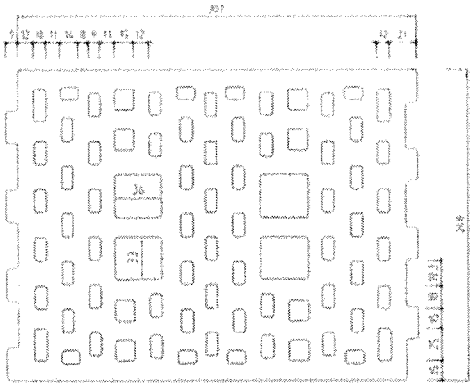
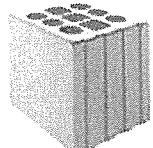
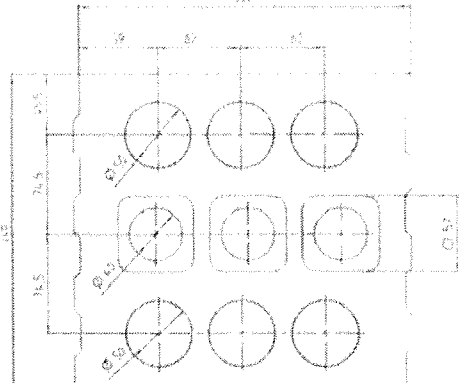
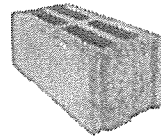
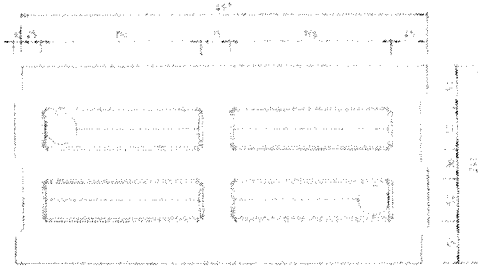
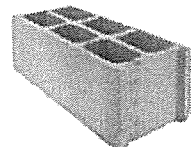
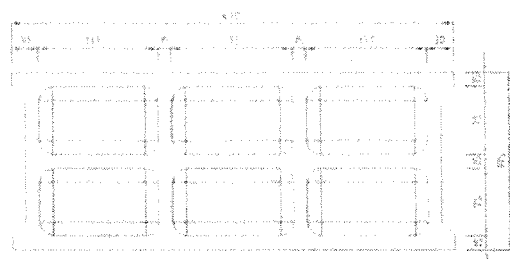

Tabela B5: Parametry montażu pręta gwintowanego HIT-V-... z tuleją siatkową HIT-SC w pustakach oraz ceglach pełnych (rys. A1)

Pręt gwintowany HIT-V-...		M8	M10	M12
z HIT-SC		16x85	16x85	18x85
Średnica nominalna wiertła	d_0 [mm]	16	16	18
Głębokość otworu	h_0 [mm]	95	95	95
Czynna głębokość zakotwienia	h_{ef} [mm]	80	80	80
Maksymalna średnica otworu przelotowego w elemencie mocowanym	d_f [mm]	9	12	14
Minimalna grubość ścianki	h_{min} [mm]	115	115	115
Szczotka stalowa HIT-RB	- [-]	16	16	18
Maksymalny moment dokręcania dla wszystkich typów cegieł poza „parpaing creux”	T_{max} [Nm]	3	4	6
Maksymalny moment dokręcania dla „parpaing creux”	T_{max} [Nm]	2	2	3
Liczba naciśnień spustu dozownika HDM	- [-]	6	6	8
Liczba naciśnień spustu dozownika HDE-500	- [-]	5	5	6

Tabela B6: Parametry montażu tulei z gwintem wewnętrznym HIT-IC z HIT-SC w pustakach i ceglach pełnych (rys. A1)

HIT-IC		M8x80	M10x80	M12x80
z HIT-SC		16x85	18x85	22x85
Średnica nominalna wiertła	d_0 [mm]	16	18	22
Głębokość otworu	h_0 [mm]	95	95	95
Czynna głębokość zakotwienia	h_{ef} [mm]	80	80	80
Długość wkręcenia gwintu	h_s [mm]	8...75	10...75	12...75
Maksymalna średnica otworu przelotowego w elemencie mocowanym	d_f [mm]	9	12	14
Minimalna grubość ścianki	h_{min} [mm]	115	115	115
Szczotka stalowa HIT-RB	- [-]	16	18	22
Maksymalny moment dokręcania	T_{max} [Nm]	3	4	6
Liczba naciśnień spustu dozownika HDM	- [-]	6	8	10
Liczba naciśnień spustu dozownika HDE-500	- [-]	5	6	8

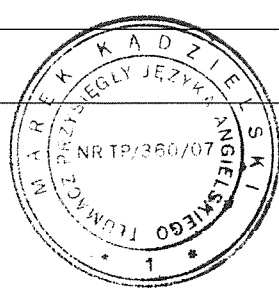
Hilti HIT-HY 170

Zamierzone zastosowanie
Parametry montażu.

Załącznik B6



Tabela B7: Parametry montażu pręta gwintowanego HIT-V-... w cegle pełnej (rys. A2)

Pręt gwintowany HIT-V-...		M8	M10	M12
Średnica nominalna wiertła	d_0 [mm]	10	12	14
Głębokość otworu = Czynna głębokość zakotwienia	$h_0 = h_{ef}$ [mm]	80	80	80
Maksymalna średnica otworu przelotowego w elemencie mocowanym	d_f [mm]	9	12	14
Minimalna grubość ścianki	h_{min} [mm]	115	115	115
Szczotka stalowa HIT-RB	- [-]	10	12	14
Maksymalny moment dokręcania	T_{max} [Nm]	5	8	10

Tabela B8: Parametry montażu tulei z gwintem wewnętrznym HIT-IC z HIT-SC w cegle pełnej (rys. A3)

HIT-IC		M8x80	M10x80	M12x80
Średnica nominalna wiertła	d_0 [mm]	14	16	18
Głębokość otworu = Czynna głębokość zakotwienia	$h_0 = h_{ef}$ [mm]	80	80	80
Długość wkręcenia gwintu	h_s [mm]	8...75	10...75	12...75
Maksymalna średnica otworu przelotowego w elemencie mocowanym	d_f [mm]	9	12	14
Minimalna grubość ścianki	h_{min} [mm]	115	115	115
Szczotka stalowa HIT-RB	- [-]	14	16	18
Maksymalny moment dokręcania	T_{max} [Nm]	5	8	10

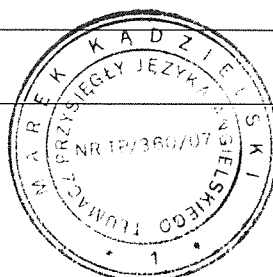
Hilti HIT-HY 170

Zamierzone zastosowanie
Parametry montażu.

Załącznik B7



Tabela B9: Maksymalny czas roboczy oraz minimalny czas utwardzania dla cegieł pełnych¹⁾

Temperatura materiału podłoża T	Maksymalny czas roboczy t_{work}	Minimalny czas utwardzania t_{cure}
od 5 °C do 10 °C	8 min	2,5 h
> 10 °C do 20 °C	5 min	1,5 h
> 20 °C do 30 °C	3 min	45 min
> 30 °C do 40 °C	2 min	30 min

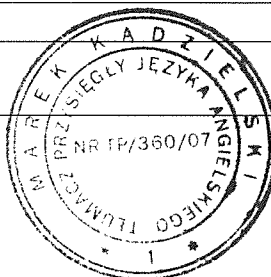

¹⁾ Dane czasu utwardzania obowiązują wyłącznie dla suchego materiału podłoża.
W przypadku mokrego materiału podłoża, czas utwardzania należy zwiększyć dwukrotnie.

Tabela B10: Maksymalny czas roboczy oraz minimalny czas utwardzania dla pustaków¹⁾

Temperatura materiału podłoża: T	Maksymalny czas roboczy t_{work}	Minimalny czas utwardzania t_{cure}
od -5 °C do 0 °C	10 min	12 h
> 0 °C do 5 °C	10 min	5 h
> 5 °C do 10 °C	8 min	2,5 h
> 10 °C do 20 °C	5 min	1,5 h
> 20 °C do 30 °C	3 min	45 min
> 30 °C do 40 °C	2 min	30 min

¹⁾ Dane czasu utwardzania obowiązują wyłącznie dla suchego materiału podłoża.
W przypadku mokrego materiału podłoża, czas utwardzania należy zwiększyć dwukrotnie.

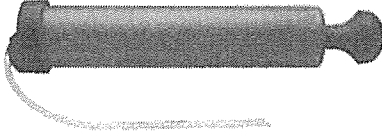
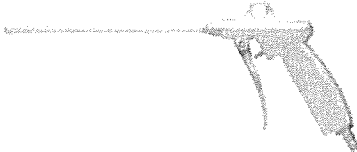
Tabela B11: Narzędzia do czyszczenia

<p>Czyszczenie ręczne (MC): Pompa ręczna Hilti do przedmuchiwania otworów</p>	
<p>Czyszczenie sprężonym powietrzem (CAC)¹⁾: Dysza do sprężonego powietrza o średnicy co najmniej 3,5 mm do przedmuchiwania otworów</p>	
<p>Szczotka stalowa HIT-RB: według tabeli B5 do B8, w zależności od średnicy otworu do czyszczenia manualnego lub sprężonym powietrzem</p>	

¹⁾ Dopuszczalne czyszczenie sprężonym powietrzem (CAC).

Hilti HIT-HY 170

Zamierzone zastosowanie
Maksymalny czas roboczy oraz minimalny czas utwardzania.
Narzędzia do czyszczenia.

Załącznik B8

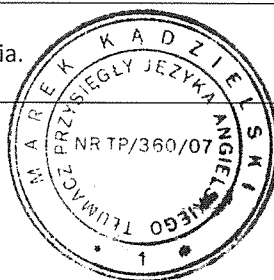

Montaż

Wiercenie otworów

Jeśli podczas wiercenia na całej głębokości nie jest wyczuwalny opór (np. niewypełnione połączenia na styk), nie należy osadzać kotwy w wykonanym otworze.

Tryb wiercenia

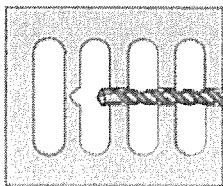

Pustaki (kategoria zastosowania c): tryb obrotowy

Nawiercić otwór do wymaganej głębokości zakotwienia wiertarką udarową w trybie obrotowym z użyciem odpowiedniego rozmiaru wiertła z końcówką z węglika.

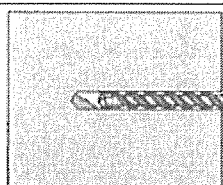

Cegły pełne (kategoria zastosowania b): tryb udarowy

Nawiercić otwór do wymaganej głębokości zakotwienia wiertarką udarową w trybie udarowym z użyciem odpowiedniego rozmiaru wiertła z końcówką z węglika.

Czyszczenie otworów

Przed osadzeniem kotwy usunąć pył oraz inne zanieczyszczenia z otworu. Zanieczyszczony otwór = słaba nośność połączenia.

Czyszczenie ręczne (MC) - pustaki i cegły pełne:

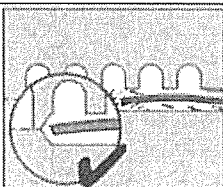

Przedmuchać co najmniej dwukrotnie od dna otworu pompą ręczną Hilti do momentu, gdy strumień powietrza nie zawiera widocznych zanieczyszczeń.

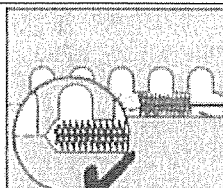

Oczyścić dwukrotnie odpowiednią szczotką (patrz tabela B5 do B8) przez włożenie, obrót oraz wyjęcie szczotki stalowej Hilti HIT-RB z otworu.

Szczotka powinna napotykać opór podczas wkładania do otworu (\varnothing szczotki $\geq \varnothing$ otworu) - szczotkę o zbyt małej średnicy należy wymienić na szczotkę o odpowiedniej średnicy.

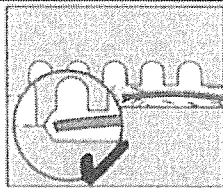

Przedmuchać ponownie pompą ręczną Hilti co najmniej dwukrotnie, do momentu gdy strumień powietrza nie zawiera widocznych zanieczyszczeń.

Hilti HIT-HY 170

Zamierzone zastosowanie
Instrukcja montażu.

Załącznik B9

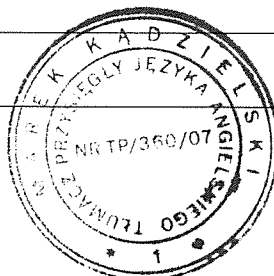

Przygotowanie do wklejania w konstrukcji murowej z otworami lub pustymi przestrzeniami z użyciem tulei siatkowej HIT-SC



Tuleja siatkowa HIT-SC
Założyć nasadkę.

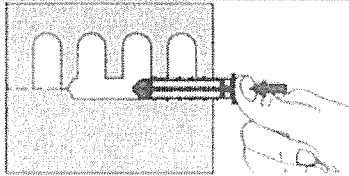

Ręcznie włożyć tuleję siatkową.

Wszystkie zastosowania

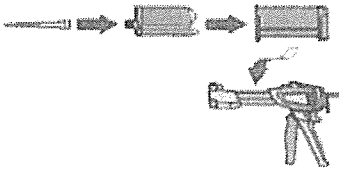

Zamocować mieszacz statyczny Hilti HIT-RE-M do kasety na opakowanie foliowe. Nie modyfikować mieszacza statycznego. Przestrzegać instrukcji obsługi dozownika oraz opakowania foliowego. Sprawdzić, czy kasetka opakowania foliowego działa prawidłowo. Nie stosować uszkodzonych opakowań foliowych i kaset. Włożyć opakowanie foliowe do kasety oraz umieścić kasetę w dozowniku HIT.

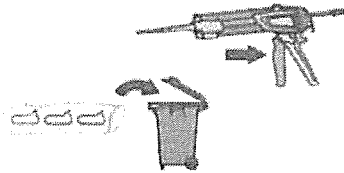

Nie stosować początkowej partii żywicy. Opakowanie foliowe jest otwierane automatycznie po rozpoczęciu dozowania. W zależności od rozmiaru opakowania foliowego, nie należy stosować początkowej partii żywicy. Ilości żywicy, których nie należy stosować:
2 naciśnięcia spustu dozownika dla opakowania foliowego 330 ml,
3 naciśnięcia spustu dozownika dla opakowania foliowego 500 ml,

Wprowadzić żywicę unikając tworzenia pustych przestrzeni.

Montaż z tuleją siatkową HIT-SC

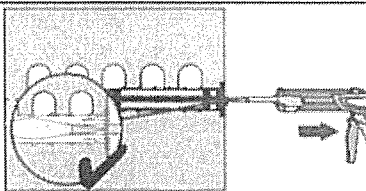

Tuleja siatkowa HIT-SC
Wprowadzić mieszacz statyczny na głębokość około 1 cm przez nasadkę. Wprowadzić wymaganą ilość żywicy (patrz tabela B5 oraz B6). Żywica powinna wypłynąć przez nasadkę.

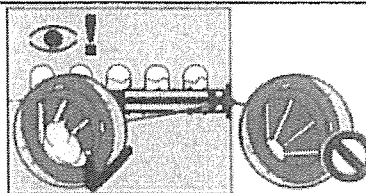

Kontrolować ilość wprowadzanej żywicy. Żywica powinna wystawać poza nasadkę. Po zakończeniu dozowania, zwolnić dozownik naciskając dźwignię odprężającą. Pozwoli to zapobiec wypływowi żywicy z mieszacza statycznego.

Hilti HIT-HY 170

Zamierzone zastosowanie
Instrukcja montażu.

Załącznik B10

Cegły pełne: montaż bez tulei siatkowej

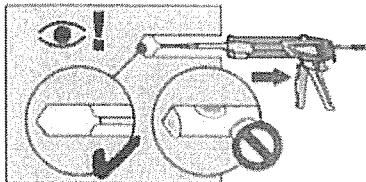

Wprowadzić żywicę od dna otworu, powoli wysuwając dozownik przy każdym naciśnięciu spustu.
Wypełnić około 2/3 otworu, aby zapewnić, że pierścieniowa szczelina pomiędzy kotwą a materiałem podłoża jest wypełniona żywicą na całej długości zakotwienia.
Po zakończeniu dozowania, zwolnić dozownik naciskając dźwignię odprężającą. Pozwoli to zapobiec wypływowi żywicy z mieszacza statycznego.

Osadzanie elementu:

Przed montażem, upewnić się że pręt jest suchy oraz nie jest zanieczyszczony olejem lub innymi pozostałościami.

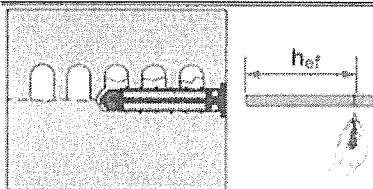

HIT-V... lub HIT-IC w ceglach pełnych lub pustakowych:

Wstępne osadzanie (rys. A1 do A3)

Oznaczyć oraz osadzić pręt na wymaganą głębokość zakotwienia do momentu upłynięcia czasu roboczego t_{work} . Czas roboczy t_{work} jest podany w tabeli B9 oraz B10.

Obciążenie kotwy

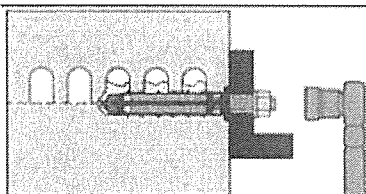

Kotwa może być obciążona po upłynięciu wymaganego czasu utwardzania t_{cure} (patrz tabela B9 oraz B10).
Moment dokręcania nie może przekraczać wartości T_{max} podanej w tabelach B5 do B8.

Hilti HIT-HY 170

Zamierzone zastosowanie
Instrukcja montażu.

Załącznik B11







Tabela C1: Współczynnik β dla prób na miejscu montażu pod obciążeniem wyciągającym

Kategorie zastosowania		w/w oraz w/d		d/d	
Zakres temperatury		Ta ¹⁾	Tb ¹⁾	Ta ¹⁾	Tb ¹⁾
Materiał podłoża	Elementy				
Cegła ceramiczna pełna EN 771-2	HIT-V ²⁾ lub HIT-IC 	0,97	0,83	0,97	0,83
	HIT-V ²⁾ + HIT-SC 				
	HIT-IC + HIT-SC 				
Cegła silikatowa pełna EN 771-2	HIT-V ²⁾ lub HIT-IC 	0,96	0,84	0,97	0,84
	HIT-V ²⁾ + HIT-SC 	0,69	0,62	0,91	0,82
	HIT-IC + HIT-SC 				
Pustak ceramiczny EN 771-1	HIT-V ²⁾ + HIT-SC 	0,97	0,83	0,97	0,83
	HIT-IC + HIT-SC 				
Pustak silikatowy EN 771-2	HIT-V ²⁾ + HIT-SC 	0,69	0,62	0,91	0,82
	HIT-IC + HIT-SC 				
Pustak z betonu lekkiego EN 771-3	HIT-V ²⁾ + HIT-SC 	0,89	0,81	0,97	0,86
	HIT-IC + HIT-SC 				
Pustak z betonu standardowego EN 771-3	HIT-V ²⁾ + HIT-SC 	0,97	0,80	0,97	0,80
	HIT-IC + HIT-SC 				

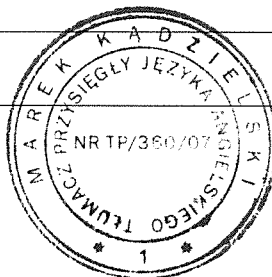
¹⁾ Zakres temperatury Ta / Tb patrz załącznik B1.

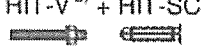
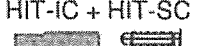
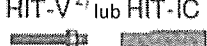
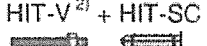
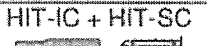
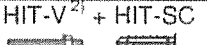
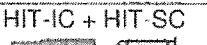
²⁾ Mogą być stosowane standardowe pręty gwintowane dostępne na rynku.

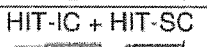
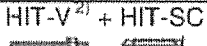
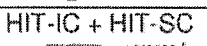
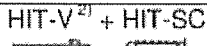
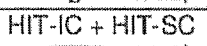
Hilti HIT-HY 170

Właściwości użytkowe

Wartości współczynnika β dla prób na miejscu montażu pod obciążeniem wyciągającym.

Załącznik C1



Tabela C2: Nośności charakterystyczne pręta gwintowanego HIT-V-... pod obciążeniem wyciągającym i ścinającym w konstrukcji murowej

HIT-HY 170 z prętem gwintowanym HIT-V-...	M8	M10	M12
Zniszczenie stali pod obciążeniem wyciągającym			
Nośność charakterystyczna stali	$N_{Rk,s}$	[kN]	$A_s \cdot f_{uk}$
Zniszczenie stali pod obciążeniem ścinającym bez oddziaływania momentu zginającego			
Nośność charakterystyczna stali	$V_{Rk,s}$	[kN]	$0,5 \cdot A_s \cdot f_{uk}$
Zniszczenie stali pod obciążeniem ścinającym z oddziaływaniem momentu zginającego			
Charakterystyczny moment zginający	$M_{Rk,s}$	[kN]	$1,2 \cdot W_{el} \cdot f_{uk}$

Tabela C3: Nośności charakterystyczne pręta z gwintem wewnętrznym HIT-IC pod obciążeniem wyciągającym i ścinającym w konstrukcji murowej

HIT-HY 170 z HIT-IC	M8	M10	M12
Zniszczenie stali pod obciążeniem wyciągającym			
Nośność charakterystyczna stali	$N_{Rk,s}$	[kN]	5,9 7,3 13,8
Częściowy współczynnik bezpieczeństwa	$\gamma_{Ms,N}$	[-]	1,50
Zniszczenie stali pod obciążeniem ścinającym bez oddziaływania momentu zginającego			
Nośność charakterystyczna stali	$V_{Rk,s}$	[kN]	$0,5 \cdot A_s \cdot f_{uk}$
Zniszczenie stali pod obciążeniem ścinającym z oddziaływaniem momentu zginającego			
Charakterystyczny moment zginający	$M_{Rk,s}$	[Nm]	$1,2 \cdot W_{el} \cdot f_{uk}$

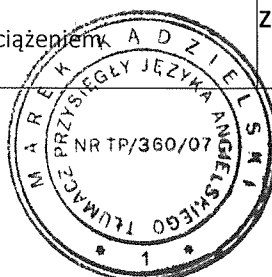
Hilti HIT-HY 170

Właściwości użytkowe

Nośności charakterystyczne pod obciążeniem wyciągającym oraz ścinającym zniszczenie stali.

Załącznik C2

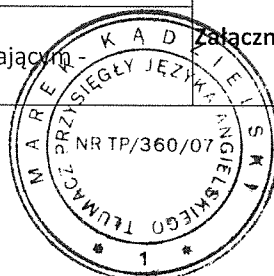

Typ cegły: Cegła ceramiczna pełna Mz, 2DF

Tabela C4: Opis cegły

Typ cegły		[-]	Pełna Mz, 2DF	
Gęstość objętościowa	ρ	[kg/dm ³]	$\geq 2,0$	
Nośność na ściskanie	f_b	[N/mm ²]	≥ 12	
Kod		[-]	EN 771 -1	
Producent		[-]	-	
Wymiary cegły		[mm]	$\geq 240 \times 115 \times 113$	
Minimalna grubość ścianki	h_{min}	[mm]	≥ 115	





Tabela C5: Parametry montażu dla wszystkich kombinacji kotwy (patrz tabela B3)

Typ kotwy		patrz tabela B3
Odległość od krawędzi	$c_{min} = c_{cr}$ [mm]	115
	$s_{min \parallel} = s_{cr \parallel}$ [mm]	240
Rozstaw	$s_{min \perp} = s_{cr \perp}$ [mm]	115

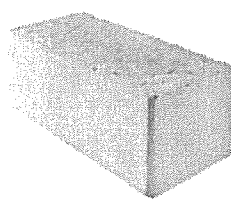
Tabela C6: Współczynnik grupowy dla mocowań grupowych

$\alpha_{g,N} \parallel \alpha_{g,V} \parallel \alpha_{g,N \perp} \alpha_{g,V \perp}$ [-]	
Współczynnik grupowy	2 przy c_{cr} oraz s_{cr}

Tabela C7: Charakterystyczna nośność na rozciąganie przy odległości od krawędzi $c \geq c_{cr}$

Kategoria zastosowania				w/w = w/d		d/d	
Zakres temperatury pracy				(Ta)	(Tb)	(Ta)	(Tb)
Typ i rozmiar kotwy	h_{ef} [mm]	f_b [N/mm ²]	N_{Rk} [kN]				
HIT-V ¹⁾  M8, M10, M12	80	12	3,0	2,5	3,0	2,5	
HIT-IC  M8	80	12	3,0	2,5	3,0	2,5	
			4,0	3,5	4,0	3,5	
HIT-V ¹⁾ + HIT-SC  M8, M10, M12	80	12	4,0	3,5	4,0	3,5	
HIT-IC + HIT-SC  M8, M10, M12	80	12	4,0	3,5	4,0	3,5	

¹⁾ Mogą być stosowane standardowe pręty gwintowane dostępne na rynku.

Tabela C8: Charakterystyczna nośność na ścinanie przy odległości od krawędzi $c \geq c_{cr}$

Kategoria zastosowania			w/w = w/d		d/d	
Zakres temperatury pracy			(Ta)	(Tb)	(Ta)	(Tb)
Typ i rozmiar kotwy	h_{ef} [mm]	f_b [N/mm ²]	V_{Rk} [kN]			
Wszystkie kotwy M8, M10, M12	80	12	3,5			

Tabela C9: Przemieszczenia

h_{ef} [mm]	N [kN]	δ_{N0} [mm]	$\delta_{N\infty}$ [mm]	V [kN]	δ_{V0} [mm]	$\delta_{V\infty}$ [mm]
80	0,9	0,2	0,4	1,0	1,0	1,5

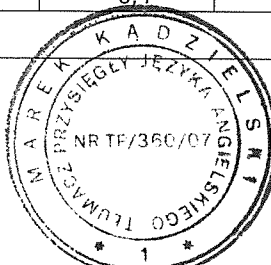

Tłumaczenie na język angielski opracowane przez DIBt
Tłumaczenie z języka angielskiego na język polski wykonane na zlecenie Hilti

Hilti HIT-HY 170 Właściwości użytkowe cegły ceramicznej pełnej Mz, 2DF Parametry montażu dla współczynnika grupowego. Nośności charakterystyczne pod obciążeniem wyciągającym oraz ścinającym. Przemieszczenia.	Załącznik C3
--	---------------------

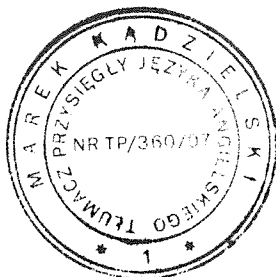

Typ cegły: Cegła silikatowa pełna KS, 2DF

Tabela C10: Opis cegły

Typ cegły		[-]	Pełna KS, 2DF	
Gęstość objętościowa	ρ	[kg/dm ³]	$\geq 2,0$	
Nośność na ściskanie	f_b	[N/mm ²]	≥ 12 lub ≥ 28	
Kod		[-]	EN 771 - 2	
Producent		[-]	-	
Wymiary cegły		[mm]	$\geq 240 \times 115 \times 113$	
Minimalna grubość ścianki	h_{min}	[mm]	≥ 115	

Tabela C11: Parametry montażu dla wszystkich kombinacji kotwy (patrz tabela B3)





Typ kotwy		patrz tabela B3
Odległość od krawędzi	$c_{min} = c_{cr}$ [mm]	115
	$s_{min \parallel} = s_{cr \parallel}$ [mm]	240
Rozstaw	$s_{min \perp} = s_{cr \perp}$ [mm]	115

Tabela C12: Współczynnik grupowy dla mocowań grupowych

$\alpha_{g,N \parallel} \alpha_{g,V \parallel} \alpha_{g,N \perp} \alpha_{g,V \perp}$ [-]	2 przy c_{cr} oraz s_{cr}
Współczynnik grupowy	

Tabela C13: Charakterystyczna nośność na rozciąganie przy odległości od krawędzi

$c \geq c_{cr}$

Kategoria zastosowania			w/w = w/d		d/d	
Zakres temperatury pracy			(Ta)	(Tb)	(Ta)	(Tb)
Typ i rozmiar kotwy	h_{ef} [mm]	f_b [N/mm ²]	N_{Rk} [kN]			
HIT-V ¹⁾ 	80	12	5,5	5,0	6,0	5,0
HIT-IC 		28	8,5	7,5	8,5	7,5
HIT-V ¹⁾ + HIT-SC 	80	12	4,0	3,5	5,5	5,0
HIT-IC + HIT-SC 		28	6,0	5,5	8,0	7,5

¹⁾ Mogą być stosowane standardowe pręty gwintowane dostępne na rynku.

Tabela C14: Charakterystyczna nośność na ścinanie przy odległości od krawędzi $c \geq c_{cr}$

Kategoria zastosowania			w/w = w/d		d/d	
Zakres temperatury pracy			(Ta)	(Tb)	(Ta)	(Tb)
Typ i rozmiar kotwy	h_{ef} [mm]	f_b [N/mm ²]	V_{Rk} [kN]			
Wszystkie kotwy M8, M10, M12	80	12	4,0			
		28	6,0			

Tabela C15: Przemieszczenia

h_{ef} [mm]	N [kN]	δ_{N0} [mm]	$\delta_{N\infty}$ [mm]	V [kN]	δ_{V0} [mm]	$\delta_{V\infty}$ [mm]
---------------	--------	--------------------	-------------------------	--------	--------------------	-------------------------

Hilti HIT-HY 170

Właściwości użytkowe cegły silikatowej pełnej KS, 2DF

Załącznik C4

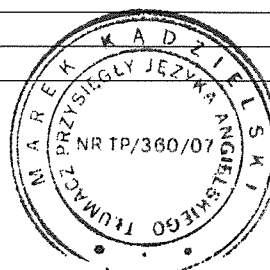

Tłumaczenie na język angielski opracowane przez DIBt
Tłumaczenie z języka angielskiego na język polski wykonane na zlecenie Hilti

Parametry montażu dla współczynnika grupowego. Nośności charakterystyczne pod obciążeniem wyciągającym oraz ścinającym. Przemieszczenia.	
--	--



Typ cegły: Pustak ceramiczny Hlz, 10DF

Tabela C16: Opis cegły

Typ cegły	[-]	Hlz 12-1,4-10 DF	 Ilustracja cegły, patrz tabela B4
Gęstość objętościowa	ρ [kg/dm ³]	$\geq 1,4$	
Nośność na ściskanie	f_b [N/mm ²]	≥ 12 lub ≥ 20	
Kod	[-]	EN 771 -1	
Producent	[-]	Rapis (D)	
Wymiary cegły	[mm]	300 x 240 x 238	
Minimalna grubość ścianki	h_{min} [mm]	≥ 240	

Tabela C17: Parametry montażu dla wszystkich kombinacji kotwy (patrz tabela B3)



Typ kotwy	patrz tabela B3	
Odległość od krawędzi	$c_{min} = c_{cr}$ [mm]	150
Rozstaw	$s_{min \parallel} = s_{cr \parallel}$ [mm]	300
	$s_{min \perp} = s_{cr \perp}$ [mm]	240

Tabela C18: Współczynnik grupowy dla mocowań grupowych

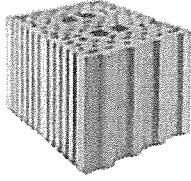
$\alpha_{g,N \parallel} \alpha_{g,V \parallel} \alpha_{g,N \perp} \alpha_{g,V \perp}$ [-]	
Współczynnik grupowy	2 przy c_{cr} oraz s_{cr}

Tabela C19: Charakterystyczna nośność na rozciąganie przy odległości od krawędzi

$c \geq c_{cr}$

Kategoria zastosowania			w/w = w/d		d/d	
Zakres temperatury pracy			(Ta)	(Tb)	(Ta)	(Tb)
Typ i rozmiar kotwy	h_{ef} [mm]	f_b [N/mm ²]	N_{Rk} [kN]			
HIT-V ¹⁾ + HIT-SC 	80	12	3,0	2,5	3,0	2,5
HIT-IC + HIT-SC 		20	3,5	3,0	3,5	3,0

¹⁾ Mogą być stosowane standardowe pręty gwintowane dostępne na rynku.

Tabela C20: Charakterystyczna nośność na ścinanie przy odległości od krawędzi $c \geq c_{cr}$

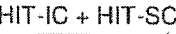
Kategoria zastosowania			w/w = w/d d/d			
Zakres temperatury pracy			(Ta)	(Tb)	(Ta)	(Tb)
Typ i rozmiar kotwy	h_{ef} [mm]	f_b [N/mm ²]	V_{Rk} [kN]			
HIT-V ¹⁾ + HIT-SC 	80	12	2,0			
HIT-IC + HIT-SC 		20	3,0			

¹⁾ Mogą być stosowane standardowe pręty gwintowane dostępne na rynku.

Tabela C21: Przemieszczenia

h_{ef} [mm]	N [kN]	δ_{N0} [mm]	$\delta_{N\infty}$ [mm]	V [kN]	δ_{V0} [mm]	$\delta_{V\infty}$ [mm]
---------------	--------	--------------------	-------------------------	--------	--------------------	-------------------------



Tłumaczenie na język angielski opracowane przez DIBt
Tłumaczenie z języka angielskiego na język polski wykonane na zlecenie Hilti

Hilti HIT-HY 170	Załącznik C5
Właściwości użytkowe pustaka ceramicznego Hlz, 10DF Parametry montażu dla współczynnika grupowego. Nośności charakterystyczne pod obciążeniem wyciągającym oraz ścinającym. Przemieszczenia.	

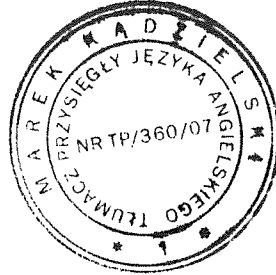

Typ cegły: Pustak silikatowy KSL, 8DF

Tabela C22: Opis cegły

Typ cegły	[-]	KSL-12-1,4-8 DF	 Ilustracja cegły, patrz tabela B4
Gęstość objętościowa	ρ [kg/dm ³]	$\geq 1,4$	
Nośność na ściskanie	f_b [N/mm ²]	≥ 12 lub ≥ 20	
Kod	[-]	EN 771 - 2	
Producent	[-]	KS Südbayern (D)	
Wymiary cegły	[mm]	248 x 240 x 238	
Minimalna grubość ścianki	h_{min} [mm]	≥ 240	



Tabela C23: Parametry montażu dla wszystkich kombinacji kotwy (patrz tabela B3)

Typ kotwy	patrz tabela B3	
Odległość od krawędzi	$c_{min} = c_{cr}$ [mm]	125
Rozstaw	$s_{min \parallel} = s_{cr \parallel}$ [mm]	248
	$s_{min \perp} = s_{cr \perp}$ [mm]	240

Tabela C24: Współczynnik grupowy dla mocowań grupowych

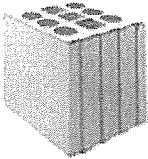

$\alpha_{g,N \parallel} \alpha_{g,v \parallel} \alpha_{g,N \perp} \alpha_{g,v \perp} [-]$	2 przy c_{cr} oraz s_{cr}
Współczynnik grupowy	

Tabela C25: Charakterystyczna nośność na rozciąganie przy odległości od krawędzi $c \geq c_{cr}$

Kategoria zastosowania			w/w = w/d		d/d	
Zakres temperatury pracy			(Ta)	(Tb)	(Ta)	(Tb)
Typ i rozmiar kotwy	h_{ef} [mm]	f_b [N/mm ²]	N_{Rk} [kN]			
HIT-V ¹⁾ + HIT-SC  M8, M10, M12 HIT-IC + HIT-SC 	80	12	3,0	2,5	3,5	3,0
		20	4,0	3,5	5,0	4,5

¹⁾ Mogą być stosowane standardowe pręty gwintowane dostępne na rynku.

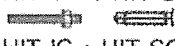
Tabela C26: Charakterystyczna nośność na ścinanie przy odległości od krawędzi $c \geq c_{cr}$

Kategoria zastosowania			w/w = w/d		d/d	
Zakres temperatury pracy			(Ta)	(Tb)	(Ta)	(Tb)
Typ i rozmiar kotwy	h_{ef} [mm]	f_b [N/mm ²]	V_{Rk} [kN]			
HIT-V ¹⁾ + HIT-SC  M8, M10, M12 HIT-IC + HIT-SC 	80	12	8,5			
		20	12,0			

¹⁾ Mogą być stosowane standardowe pręty gwintowane dostępne na rynku.

Tabela C27: Przemieszczenia

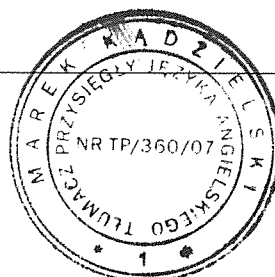

Tłumaczenie na język angielski opracowane przez DIBt
Tłumaczenie z języka angielskiego na język polski wykonane na zlecenie Hilti

80	1,8	0,2	0,3	3,4	2,5	3,8
Hilti HIT-HY 170 Właściwości użytkowe pustaka silikatowego KSL, 8DF Parametry montażu dla współczynnika grupowego. Nośności charakterystyczne pod obciążeniem wyciągającym oraz ścinającym. Przemieszczenia.						Załącznik C6

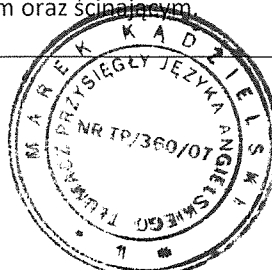

Typ cegły: Pustak z betonu lekkiego Hbl, 16DF

Tabela C28: Opis cegły

Typ cegły	[-]	Hbl-4-0,7	 <p>Ilustracja cegły, patrz tabela B4</p>
Gęstość objętościowa	ρ [kg/dm ³]	$\geq 0,8$	
Nośność na ściskanie	f_b [N/mm ²]	≥ 2 lub ≥ 6	
Kod	[-]	EN 771-3	
Producent	[-]	Knobel (D)	
Wymiary cegły	[mm]	495 x 240 x 238	
Minimalna grubość ścianki	h_{min} [mm]	≥ 240	



Tabela C29: Parametry montażu dla wszystkich kombinacji kotwy (patrz tabela B3)

Typ kotwy	patrz tabela B3	
Odległość od krawędzi	$c_{min} = c_{cr}$ [mm]	250
	$s_{min \parallel} = s_{cr \parallel}$ [mm]	240
Rozstaw	$s_{min \perp} = s_{cr \perp}$ [mm]	240

Tabela C30: Współczynnik grupowy dla mocowań grupowych

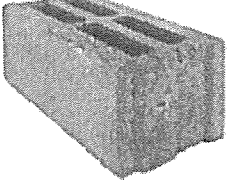
Współczynnik grupowy	2 przy c_{cr} oraz s_{cr}
$\alpha_{g,N \parallel} \alpha_{g,V \parallel} \alpha_{g,N \perp} \alpha_{g,V \perp}$ [-]	

Tabela C31: Charakterystyczna nośność na rozciąganie przy odległości od krawędzi $c \geq c_{cr}$

Kategoria zastosowania			w/w = w/d		d/d	
Zakres temperatury pracy			(Ta)	(Tb)	(Ta)	(Tb)
Typ i rozmiar kotwy	h_{ef} [mm]	f_b [N/mm ²]	N_{Rk} [kN]			
HIT-V ¹⁾ + HIT-SC  M8, M10, M12	80	2	1,2	0,9	1,5	1,2
HIT-IC + HIT-SC  M8, M10, M12		6	2,0	1,5	2,5	2,0

¹⁾ Mogą być stosowane standardowe pręty gwintowane dostępne na rynku.

Tabela C32: Charakterystyczna nośność na ścinanie przy odległości od krawędzi $c \geq c_{cr}$

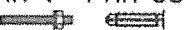
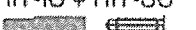
Kategoria zastosowania			w/w = w/d		d/d	
Zakres temperatury pracy			(Ta)	(Tb)	(Ta)	(Tb)
Typ i rozmiar kotwy	h_{ef} [mm]	f_b [N/mm ²]	V_{Rk} [kN]			
HIT-V ¹⁾ + HIT-SC  M8, M10, M12	80	2	2,5			
HIT-IC + HIT-SC  M8, M10, M12		6	4,0			

¹⁾ Mogą być stosowane standardowe pręty gwintowane dostępne na rynku.

Tabela C33: Przemieszczenia

h_{ef} [mm]	N [kN]	δ_{N0} [mm]	$\delta_{N\infty}$ [mm]	V [kN]	δ_{V0} [mm]	$\delta_{V\infty}$ [mm]
---------------	--------	--------------------	-------------------------	--------	--------------------	-------------------------

Tłumaczenie na język angielski opracowane przez DIBt
Tłumaczenie z języka angielskiego na język polski wykonane na zlecenie Hilti

Hilti HIT-HY 170	Załącznik C7
Właściwości użytkowe pustaka z betonu lekkiego Hbl 16DF Parametry montażu dla współczynnika grupowego. Nośności charakterystyczne pod obciążeniem wyciągającym oraz ścinającym. Przemieszczenia.	



Typ cegły: Pustak z betonu standardowego - parpaing creux

Tabela C34: Opis cegły

Typ cegły				B40	 Ilustracja cegły, patrz tabela B4
Gęstość objętościowa	ρ	[kg/dm ³]		$\geq 1,0$	
Nośność na ściskanie	f_b	[N/mm ²]		≥ 4 lub ≥ 10	
Kod				EN 771-3	
Producent				Fabemi (F)	
Wymiary cegły		[mm]		500 x 200 x 200	
Minimalna grubość ścianki	h_{min}	[mm]		≥ 200	



Tabela C35: Parametry montażu dla wszystkich kombinacji kotwy (patrz tabela B3)

Typ kotwy		patrz tabela B3
Odległość od krawędzi	$c_{min} = c_{cr}$ [mm]	200
	$s_{min II} = s_{cr II}$ [mm]	200
Rozstaw	$s_{min \perp} = s_{cr \perp}$ [mm]	200

Tabela C36: Współczynnik grupowy dla mocowań grupowych

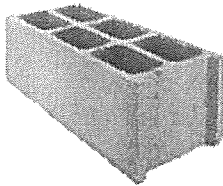

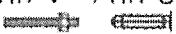
	$\alpha_{g,N} \parallel \alpha_{g,V} \parallel \alpha_{g,N \perp} \alpha_{g,V \perp}$ [-]	
Współczynnik grupowy		2 przy c_{cr} oraz s_{cr}

Tabela C37: Charakterystyczna nośność na rozciąganie przy odległości od krawędzi $c \geq c_{cr}$

Kategoria zastosowania			w/w = w/d		d/d	
Zakres temperatury pracy			(Ta)	(Tb)	(Ta)	(Tb)
Typ i rozmiar kotwy	h_{ef} [mm]	f_b [N/mm ²]	N_{Rk} [kN]			
HIT-V ¹⁾ + HIT-SC  M8, M10, M12	80	4	0,9	0,9	0,9	0,9
HIT-IC + HIT-SC 		10	1,2	1,2	1,5	1,5

¹⁾ Mogą być stosowane standardowe pręty gwintowane dostępne na rynku.

Tabela C38: Charakterystyczna nośność na ścinanie przy odległości od krawędzi $c \geq c_{cr}$

Kategoria zastosowania			w/w = w/d		d/d	
Zakres temperatury pracy			(Ta)	(Tb)	(Ta)	(Tb)
Typ i rozmiar kotwy	h_{ef} [mm]	f_b [N/mm ²]	V_{Rk} [kN]			
HIT-V ¹⁾ + HIT-SC  M8, M10, M12	80	4	2,5			
HIT-IC + HIT-SC 		10	4,0			

¹⁾ Mogą być stosowane standardowe pręty gwintowane dostępne na rynku.

Tabela C39: Przemieszczenia

h_{ef} [mm]	N [kN]	δ_{N0} [mm]	$\delta_{N\infty}$ [mm]	V [kN]	δ_{V0} [mm]	$\delta_{V\infty}$ [mm]
---------------	--------	--------------------	-------------------------	--------	--------------------	-------------------------

Hilti HIT-HY 170

Załącznik C8

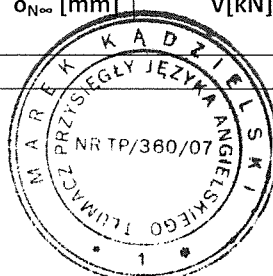

Tłumaczenie na język angielski opracowane przez DIBt
Tłumaczenie z języka angielskiego na język polski wykonane na zlecenie Hilti

Właściwości użytkowe pustaka z betonu standardowego - parpaing creux Parametry montażu dla współczynnika grupowego. Nośności charakterystyczne pod obciążeniem wyciągającym oraz ścinającym. Przemieszczenia.	
--	--

Ja, Marek Kądzielski, niżej podpisany TŁUMACZ PRZYSIĘGŁY języka angielskiego, poświadczam niniejszym zgodność tej wersji tłumaczenia z treścią okazanego mi oryginalnego dokumentu w języku angielskim.-----

Warszawa, dnia 11 września 2018 roku.-----

Repertorium nr 1047/2018.-----

Pobrano opłatę zgodnie z obowiązującą taksą za trzydzieści (30) stron uwierzytelnionych.-----

Marek Kądzielski

