



# HILTI HFB-R FIREBOARD ANCHOR

## Efectis fire test report

EFR-18-J-002325 (23.01.2019)

EFR-18-J-004839-A (05.08.2019)

EFR-18-J-004839-B (05.08.2019)

EFR-18-J-004839-D (05.08.2019)

EFR-18-J-002325	2-43
EFR-18-J-004839-A	44-58
EFR-18-J-004839-B	59-75
EFR-18-J-004839-D	76-90

## FIRE TEST REPORT EFR-18-J-002325

According to the French guide issued by CETU (Centre d'Etudes des Tunnels): "Passive fire protection systems", march 2017

<b>Test</b>	EFR-18-J-002325
<b>Performed on</b>	December 13 <sup>th</sup> , 2018
<b>Regarding</b>	Passive protection applied on a loaded concrete slab of overall dimensions : 5400 x 3000 x 140 mm (L x W x Th) : <ul style="list-style-type: none"><li>▪ Trade reference of the protecting system : PROMATECT T</li><li>▪ Thickness of the boards : 35 mm</li></ul>
<b>Sponsor</b>	HILTI FRANCE 1 rue Jean Mermoz F - 78778 MAGNY LES HAMEAUX Cedex

## 1. SCOPE OF THIS TEST REPORT

---

Fire resistance test of a loaded slab protected by a protective system according to the French guide CETU (Centre d'Etudes des Tunnels): "Passive fire protection system" - dated on March 2017.

## 2. TEST LABORATORY

---

EFFECTIS FRANCE  
149, route du Marc  
F - 38630 LES AVENIERES VEYRINS-THUELLIN

## 3. REFERENCE AND MANUFACTURER OF THE TESTED SPECIMEN

---

### **Boards:**

Reference: PROMATECT T - Batch Nr 73317  
Manufacturer: PROMAT  
BORMSTRAAT 24  
B - 2830 TISSELT

### **Anchors:**

Reference: HFB-R 6x70 40/35/30 - Batch Nr 0095021  
Manufacturer: HILTI - AUSTRIA

## 4. FURTHER INFORMATIONS FOR CE MARKING

---

*(Chapter not covered under the COFRAC's accreditation).*  
The tested element has not been collected.

## 5. DESCRIPTION OF THE TESTED SPECIMEN

---

**The informations below were provided by the applicant who attests their accuracy.**

### 5.1. GENERAL

The tested specimen was a concrete slab protected on its exposed side by protective boards PROMATECT T (PROMAT) of thickness 35 mm.

They were fixed directly on the slab with mechanical anchors type concrete screw HFB-R Ø 6 x 70 mm (HILTI).

The anchors were previously equipped with washers made of stainless steel dimensions Ø 6,5 x 30 mm and thickness 1,5 mm.

The overall dimensions were:

- Overall dimensions of the slab : 5400 x 3000 x 140 mm (L x W x Th)
- Protected area : 4600 x 3000 mm (L x W)
- Exposed area : 4500 x 3000 mm (L x W)
- Span between supporting lines : 5080 mm.

## 5.2. LIST OF THE COMPONENTS

According to the information supplied by the sponsor.

Description	Reference	Material	Characteristics	Supplier
Board	PROMATECT T	Calcium silicate	Th = 35 mm d = 1021 kg/m <sup>3</sup>	PROMAT
Anchors	HFB-R	Stainless steel A4	Ø 6 x 70 mm	HILTI
Washers	-	Stainless steel A4	Ø 8 x 30 mm Th = 1 mm	MARKET

Th = Thickness --- d = Density

## 5.3. DETAILED DESCRIPTION OF THE SPECIMEN

### 5.3.1. Concrete slab

Characteristics	Datas	
Type of slab	Large slab	
Overall dimensions	5400 x 3000 x 140 mm (L x W x Th)	
Concrete cover	20 mm	
Concrete strength class	C 25 / 30	
Aggregates	Silicious	
Reinforcing bars	According to EN 13381-3: 2015	
Date of casting	10 <sup>th</sup> September 2018	
Density - moisture content	Batch dimensions	200 x 200 x 140 mm (L x W x H)
	Density measured at the test date	2330 kg/m <sup>3</sup>
	Moisture content, after drying at 105°C	3,5 %, (% of dried weight)
Average mechanical properties of the concrete	Batch dimensions	Ø 110 x 200 mm (Ø x H)
	After 28 days of curing	30,0 MPa
	After 90 days of curing	35,5 MPa
	measured at the test date (94 days of curing)	35,6 MPa
Formwork material	Bakelized plywood	
Release agent (1 <sup>st</sup> half area)	Type of agent	Soluble water emulsion
	Implementation area	2700 x 3000 mm (L x W)
	Trade reference	FDI CIMAROL 2
	Manufacturer	FDI Z.I. en Lesnes - Rue de la scierie F - 71240 SENNECE-LE-GRAND
Release agent (2 <sup>nd</sup> half area)	Type of agent	Soluble mineral oil
	Implementation area	2700 x 3000 mm (L x W)
	Trade reference	SIKA DECOFFRE MINERAL
	Manufacturer	SIKA France 84 rue Edouard Vaillant F - 93350 LE BOURGET

## 5.3.2. Protective boards

<i>Characteristics</i>	<i>Datas</i>	
Preliminary surface preparation	No surface preparation of the concrete slab was undertaken prior to installation of boards.	
Trade board reference	PROMATECT-T	
Boards thickness	35 mm	
Batch n°	73317	
Implementation on the slab date	05/12/2018	
Density - moisture content	Batch dimensions	300 x 300 x 35 mm (L x W x H)
	Density on day of the test	1021 kg/m <sup>3</sup>
	Moisture content, after drying at 105°C	4,7 %, (% of dried weight)
Protective boards thickness 35 mm	Overall dimensions (see Appendix plates)	A : 2100 x 1200 mm (L x W) B: 2500 x 1200 mm (L x W) C: 2500 x 800 mm (L x W) D: 2100 x 800 mm (L x W) E: 1725 x 1000 mm (L x W) F: 1150 x 1000 mm (L x W) G: 1725 x 1000 mm (L x W)
	Anchors type	HFB-R Ø 6 x 70 mm (HILTI)
	Anchors distribution	See Appendix Plate
Implementation of the boards	Side by side and straight cut	
Joints	No covering joints were realized	

**5.4. VERIFICATION**

Samples coming from the same batch that has been used to build the specimen have been supplied to the test laboratory to check the information given on the description of the specimen.

**6. TEST ASSEMBLY**

---

**6.1. DEFINITION OF THE TESTED SPECIMEN**

The choice and the definition of this test specimen have been carried out by the sponsor.

**6.2. ASSEMBLY OF THE TESTED SPECIMEN**

## 6.2.1. Test mounting

The concrete slab was installed on the furnace structure and was exposed on 4100 x 3000 mm (L x w) area.

6.2.2. Staff

The test specimen had been built by the staff of the test laboratory.

The installation of the protective boards on the concrete slab had been made by the skillful staff of the Sponsor.

**7. TEST METHODE**

---

**7.1. PRELIMINARY CONDITIONNING**

The conditioning of the elements was realized in conformity with the requirements stated in norms quoted in § 1 and the hygrometric stability of the test specimens was reached on the day of the test.

**7.2. THERMAL PROGRAM**

The temperature rise inside the furnace above the ambient temperature was controlled according to the **RWS thermal program** according to the Sponsor's request, represented by the following table:

<i>Time (minutes)</i>	<i>Temperature (°C)</i>
0	20
3	890
5	1140
10	1200
30	1300
60	1350
90	1300

Then, after 90 minutes of RWS thermal program, the temperature inside the furnace above the ambient temperature was controlled according to the **Majorated Hydrocarbon Curve (HCM)**, represented by the following function:

$$T = 1280 (1 - 0,325 e^{-0,167 t} - 0,675 e^{-2,5 t}) + 20$$

Then, after 120 minutes + Δt = 132 minutes\* of RWS + HCM program, the temperature inside the furnace above the ambient temperature was controlled until the end of the test according to the **standard thermal program**, represented by the following function :

$$T = 345 \log_{10} (8t+1) + 20$$

where :

t = Time (min)  
 T = Furnace temperature at time t (°C).

\* Note (see paragraph A.11 – Figure A.7 of the guide):

The additional duration “dt1” was 4 minutes according to the following equation related to the moisture of the protective board:

$$\frac{d}{\%} (\% - 3)$$

where:

d = duration of the vaporization stage of the protective boards (min)  
 %= moisture of the protective boards (%)

The additional duration “dt2” was 12 min – 4 min = 8 minutes:

**The total additional duration Δt was: Δt = dt1 + dt2 = 12 minutes.**

**7.3. AMBIENT PRESSURE**

According to paragraph A.10 of the guide, no pressure order was followed because the pressure is considered as an uninfluential factor on the test results.

**7.4. SUPPORTING CONDITIONS AND LOAD APPLIED ON THE CONCRETE SLAB**

7.4.1. Supporting conditions

The slab was supported on 2 rolls Ø 100 mm separated by a distance of 5080 mm.

One roll was blocked in both directions; the other one was free for longitudinal movement.

7.4.2. Loaded conditions

The load was calculated such as a bending moment inducing tensile stress in the lower reinforcement bars of the concrete test slab equal to 300 MPa according to EN 13381-3: 2015.

The load was applied through a hydraulique jack.

The weights of the slab and of the protective product were taken into account in the calculus.

- Slab weight : 3200 N/m
- Protective product weight : 351 N/m.
- Span : 5080 mm.
- Load : 31,9 kN.
- Maximal bending for the load (L/30) : 169 mm.

**8. MEASUREMENTS DURING THE FIRE TEST AND TEST RESULTS**

---

The locations of the sensors are shown on appendix "Instrumentation".  
The readings are recorded on the plates, on appendix "Charts", mentioned hereafter.

**8.1. TEMPERATURE MEASUREMENTS**

8.1.1. Ambient temperature in the laboratory

The ambient temperature was measured according to the requirements of the standard EN 1363-1: 2012, by the thermocouple n° 78.

See appendix "Charts" nr 1.

8.1.2. Ambient temperature in the furnace

It was measured by 8 plate pyrometers with their metal face towards the soil of the furnace:

<i>Location</i>	<i>Marking</i>		<i>Appendix Charts</i>
At 100 mm under the exposed face	Plate pyrometers	Tc 79 to Tc 86	2
Deviations according to the tolerances in the CETU guide	Tc 79 to Tc 86		3

### 8.1.3. Temperatures of the specimen

The temperatures were measured by thermocouples according to the requirements of the CETU guide and located as following:

<i>Location</i>	<i>Marking</i>	<i>Appendix Charts</i>
At the interface of the concrete - See photos A to J in Appendix "Photographs"	1-9-17-25-33-41-49-57-62-67	6
Inside the concrete, at 15 mm from the interface	2-10-18-28-34-42-50-58-63-68	7
Inside the concrete, at 30 mm from the interface	3-11-19-27-35-43-51-59-64-69	8
Inside the concrete, at 45 mm from the interface	4-12-20-30-36-44-52	9
Inside the concrete, at 60 mm from the interface	5-13-21-26-37-45-53	10
Inside the concrete, at 75 mm from the interface	6-14-22-30-38-46-54	11
On the unexposed face	7-15-24-31-39-47-55-60	12
On the HA10 reinforcement bars	8-16-23-29-40-48-56-61-66-71	13
At a longitudinal joint between 2 boards (X)	73	14
At a transversal joint between 2 boards (Y)	75	
At a joint between 3 boards (Z)	77	

### 8.2. PRESSURE MEASUREMENTS

In conformity with the requirements of the standard EN 1363-1: 2012, the pressure inside the furnace was continuously controlled throughout the whole test.

<i>Location</i>	<i>Marking</i>	<i>Appendix Charts</i>
At 100 mm underneath the specimen	Pr 97	4

### 8.3. LOAD MEASUREMENTS

<i>Location</i>	<i>Marking</i>	<i>Appendix Charts</i>
Load applied	For 96	5

### 8.4. DEFLECTION MEASUREMENTS

<i>Location</i>	<i>Marking</i>	<i>Appendix Charts</i>
Deflection at mid-span of the slab	Dep 91-92-93	20
Deflection at mid-width of the slab	Dep 94-92-95	19

### 8.5. RATE OF DEFLECTION MEASUREMENTS

<i>Location</i>	<i>Marking</i>	<i>Appendix Charts</i>
Average rate of deflection at mid-span of the slab	$\Delta \text{Dep} / \Delta t$	21



## 9. OBSERVATIONS

---

### 9.1. BEFORE THE TEST

- Ambient temperature inside the laboratory : 15°C.
- Specimen temperature before the test : 14°C.

See photo K.

### 9.2. DURING THE TEST

Time (min)	Observations
-15	Loading of the slab.
00	Start of the test.
26	Characteristic temperature at the interface, measured by thermocouples n° 1-9-17-25-33-41-49-57-62-67, higher than 85°C.
37	Characteristic temperature at the interface, measured by thermocouples n° 1-9-17-25-33-41-49-57-62-67, higher than 100°C.
90	Switching of heating program, from RWS to HCM.
132	Switching of heating program, from HCM to standard thermal program.
271	<b>End of the test on request of the Sponsor.</b>

### 9.3. AFTER THE TEST AND COOL DOWN

All the boards were cracked in several point.

One piece of board "B", with approximate dimensions of 600 x 300 mm, has fallen in the furnace.

See photo L.

## 10. CONCLUSIONS

---

The stickability of the protective boards applied underneath the concrete slab was determined, according the paragraph A.13 of the guideline of CETU.

Time : 271 minutes  
 Cause of failure : End of the test on request of the Sponsor  
 Corresponding temperature at the interface : 447°C.

**10.1. TEMPERATURES**

10.1.1. At the interface

Time (min)	Temperatures measured at interface (°C)		
	Average	Maximum	Characteristic
30	83	94	88
60	128	180	154
90	179	205	192
120	245	338	292
132	260	355	308
150	278	367	323
180	290	368	329
210	304	388	346
240	323	412	363
270	342	446	394

10.1.2. At 15 mm deep from the interface

Time (min)	Temperatures measured at 15 mm deep from the interface (°C)		
	Average	Maximum	Characteristic
30	49	57	53
60	77	82	79
90	86	95	91
120	113	133	123
132	126	151	139
150	147	175	161
180	172	232	202
210	191	273	232
240	210	302	256
270	229	332	280

10.1.3. At 30 mm deep from the interface

Time (min)	Temperatures measured at 30 mm deep from the interface (°C)		
	Average	Maximum	Characteristic
30	39	44	41
60	67	73	70
90	77	84	80
120	100	112	106
132	105	125	115
150	121	145	133
180	144	168	156
210	163	203	183
240	181	229	205
270	198	254	226

10.1.4. On the unexposed side

Time (min)	Temperatures measured on the unexposed side (°C)		
	Average	Maximum	Characteristic
30	15	17	16
60	22	24	23
90	32	33	33
120	42	45	43
132	46	50	48
150	53	59	56
180	64	74	69
210	75	89	82
240	83	101	92
270	88	108	98

## 11. WARNING

---

'This report gives details about the construction method, the testing conditions and the test results achieved when the specific building element described was tested according to the procedure specified in standard EN 1363-1: 2012 and, where applicable, in standard EN 1363-2: 1999.

As concerns the dimensions, details, loading, stresses and boundary or end conditions, any significant deviation other than that which is not excluded within the field of direct application of the appropriate test procedure is not covered by this report.

Because of the nature of the fire tests and of the resulting difficulty in quantifying the uncertainty of the fire resistance assessment, it is impossible to establish any level of accuracy of the results.'

Les Avenières Veyrins-Thuellin, the 23<sup>th</sup> January 2019



**Guillaume SIEMONEIT**  
Project Leader



**Clifford CHINAYA**  
Testing Team Leader

APPENDIX: DRAWINGS

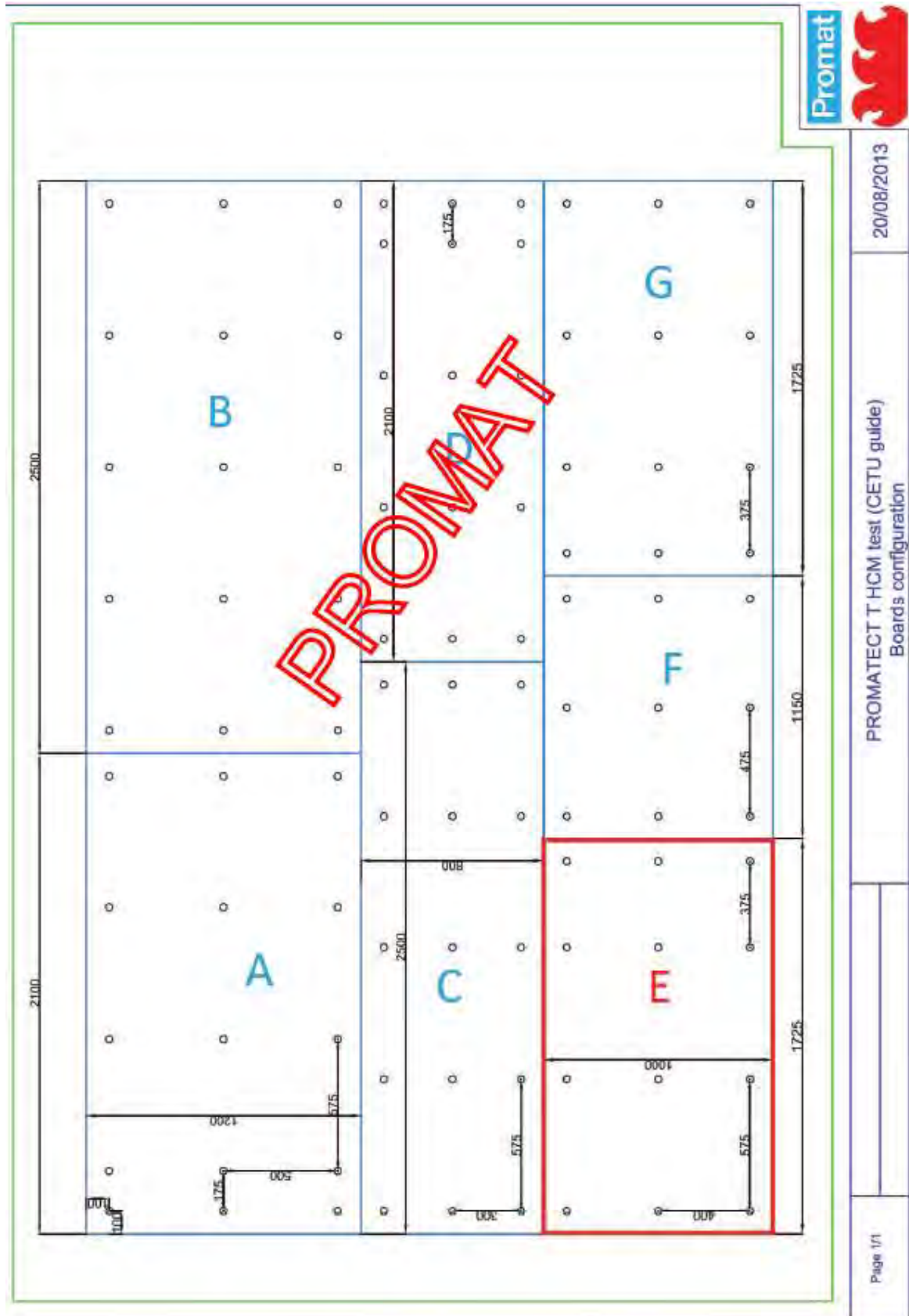

APPENDIX: INSTRUMENTATION

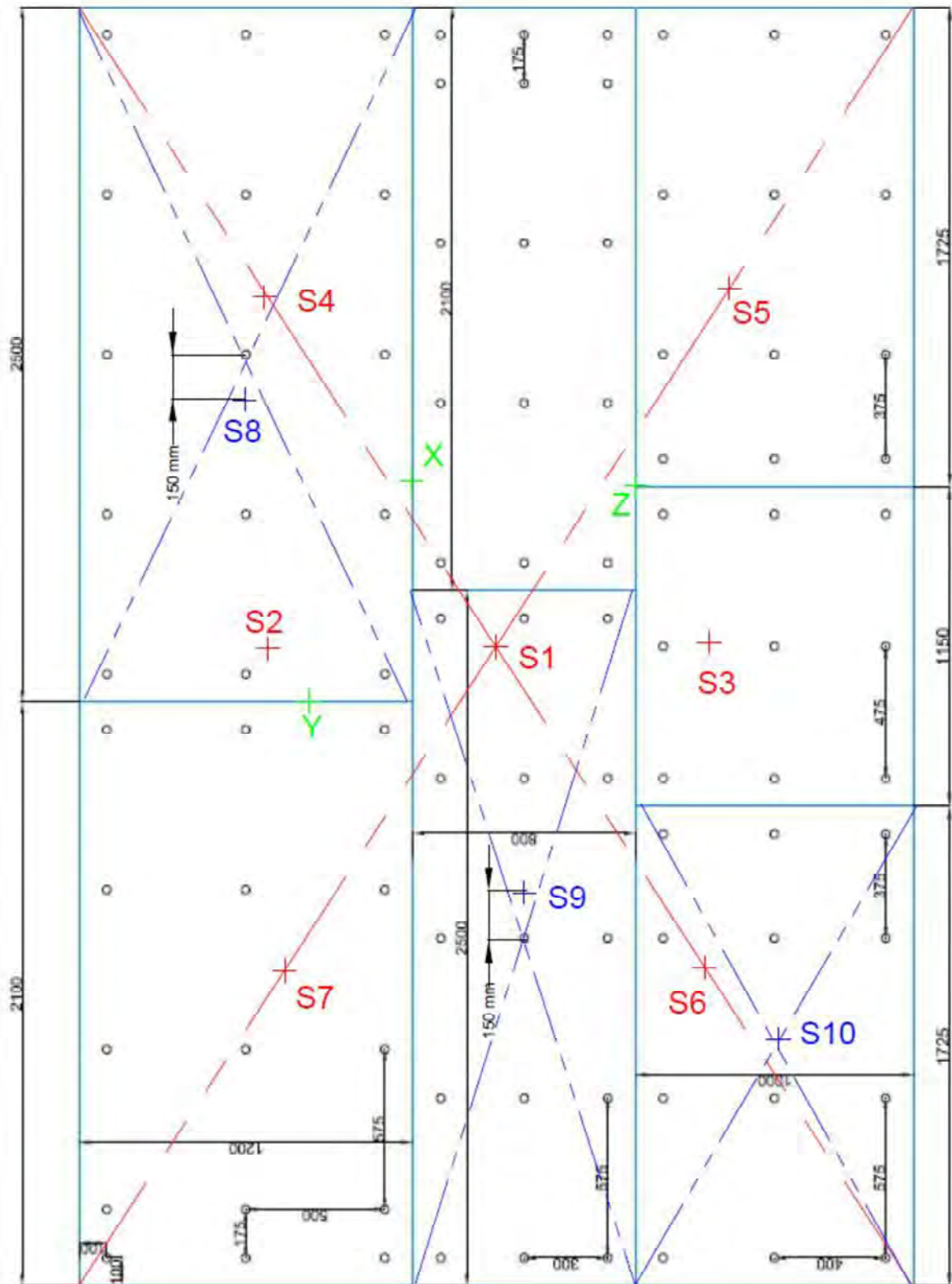

**Position of thermocouples for each section:**

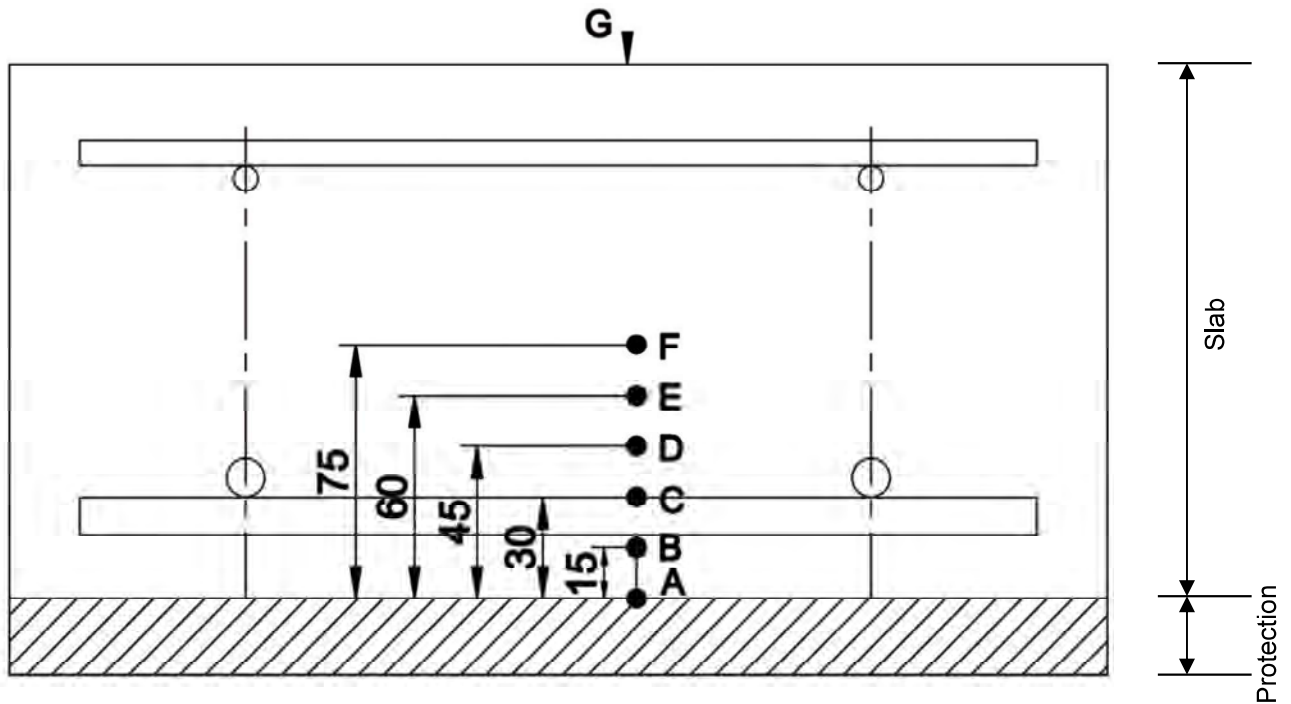

**Marking of each thermocouples:**

Section	A	B	C	D	E	F	G	HA 10	Type of thermocouples
S1	1	2	3	4	5	6	7	8	K
S2	9	10	11	12	13	14	15	16	K
S3	17	18	19	20	21	22	24	23	K
S4	25	28	27	30	26	30	31	29	K
S5	33	34	35	36	37	38	39	40	K
S6	41	42	43	44	45	46	47	48	K
S7	49	50	51	52	53	54	55	56	K
S8*	57	58	59				60	61	K
S9*	62	63	64				65	66	K
S10*	67	68	69				70	71	K
X	73								Inconel Ø1.5
Y	75								Inconel Ø1.5
Z	77								Inconel Ø1.5

APPENDIX: CHARTS

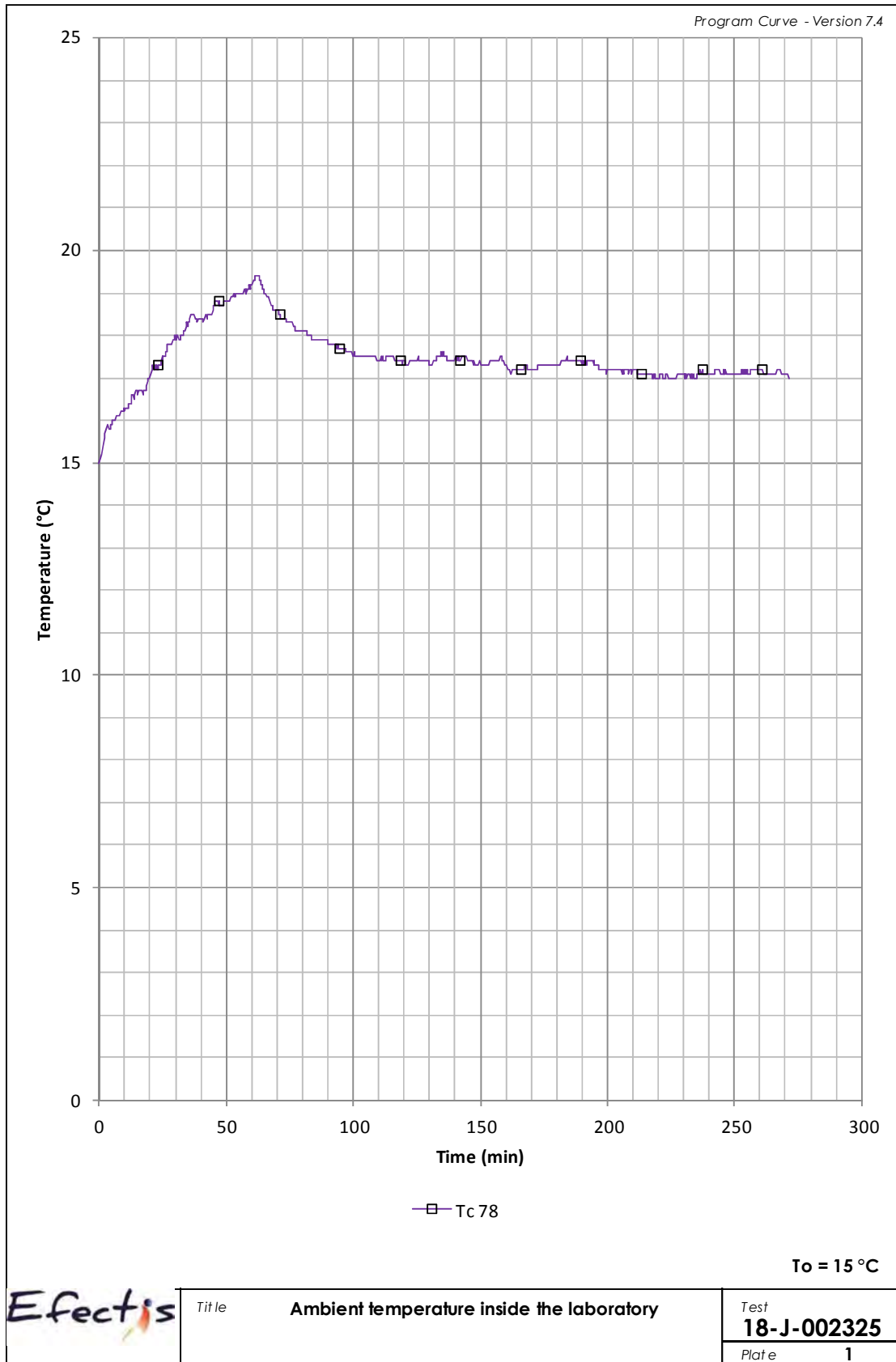



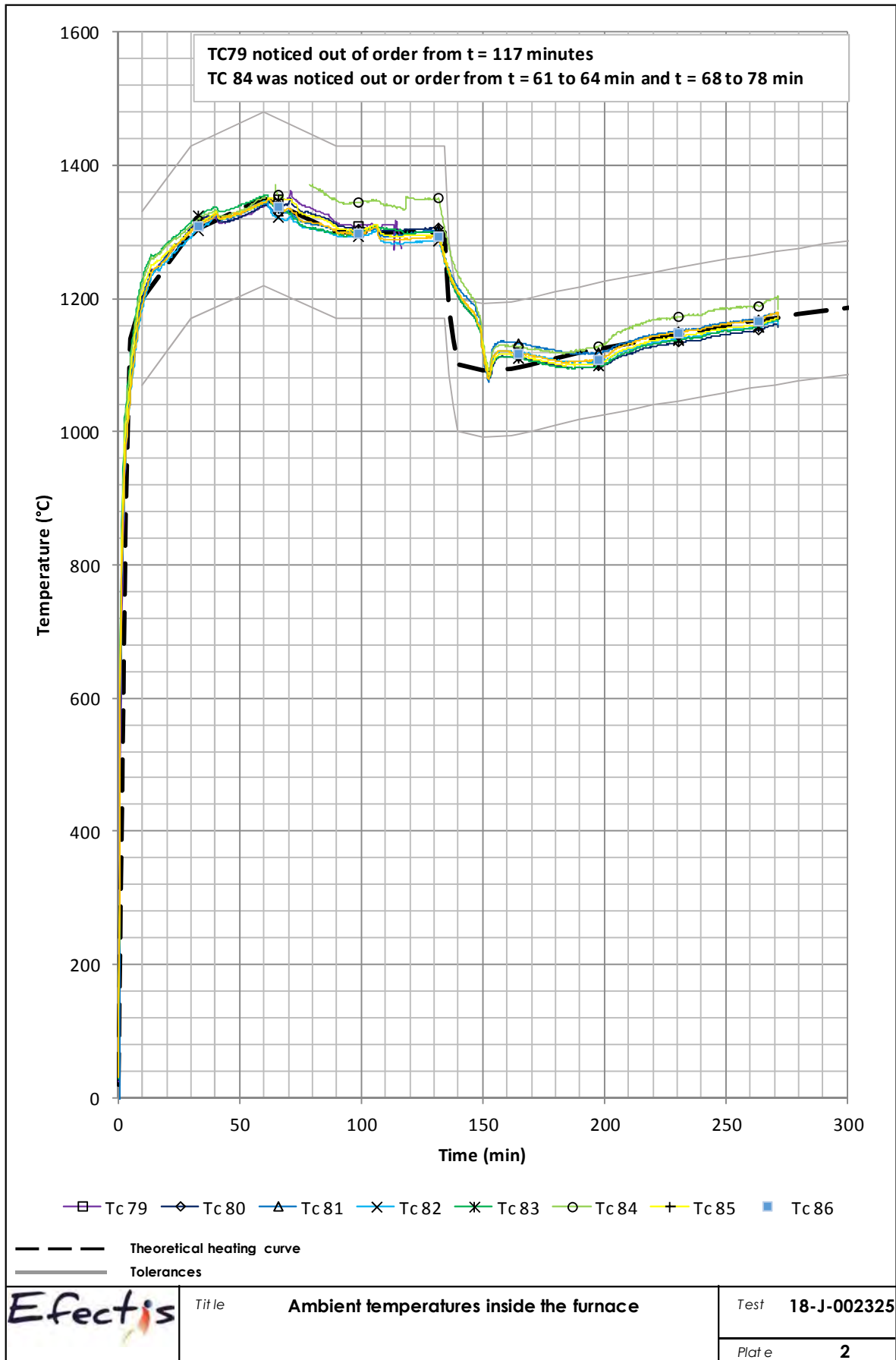

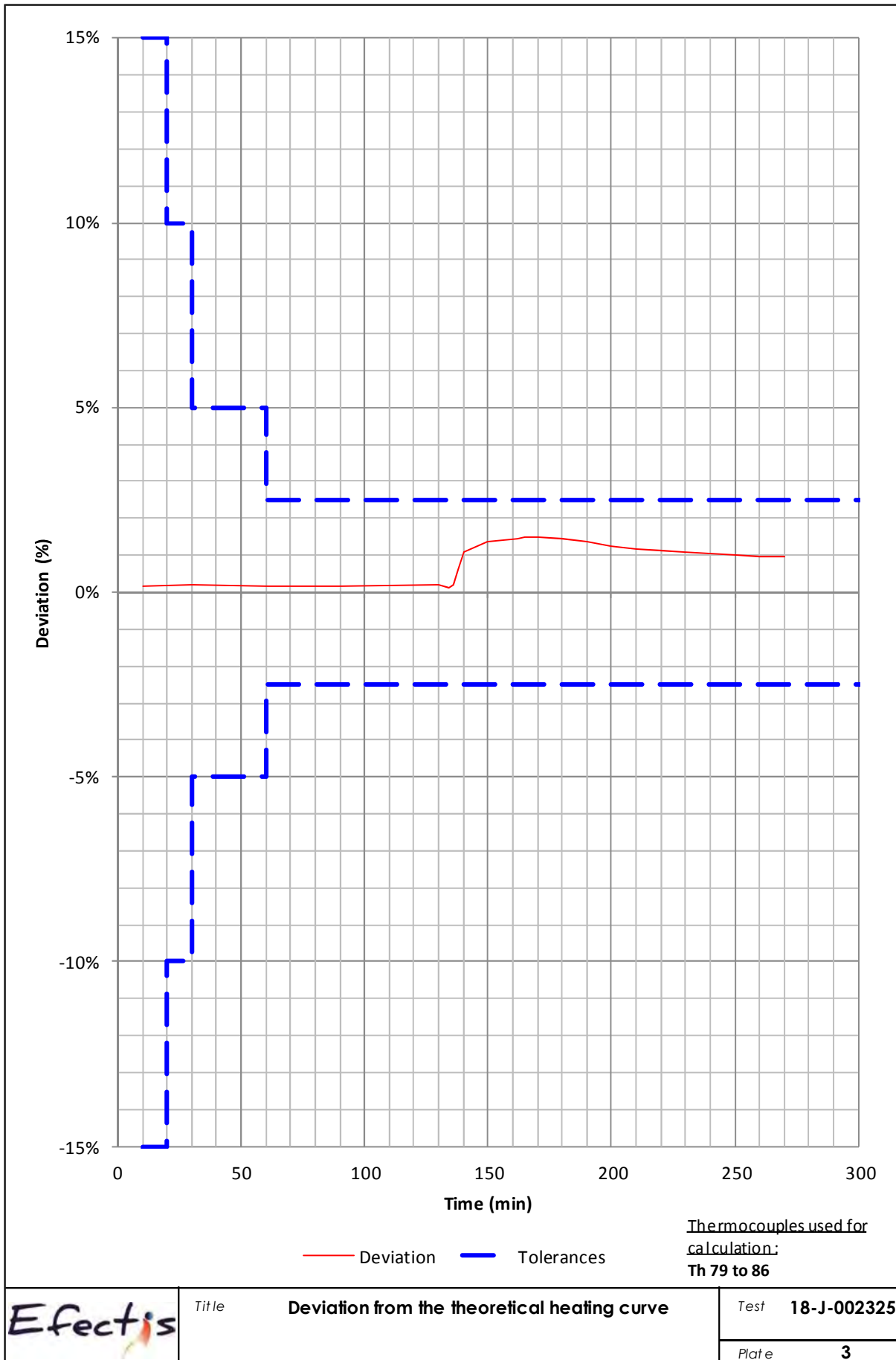

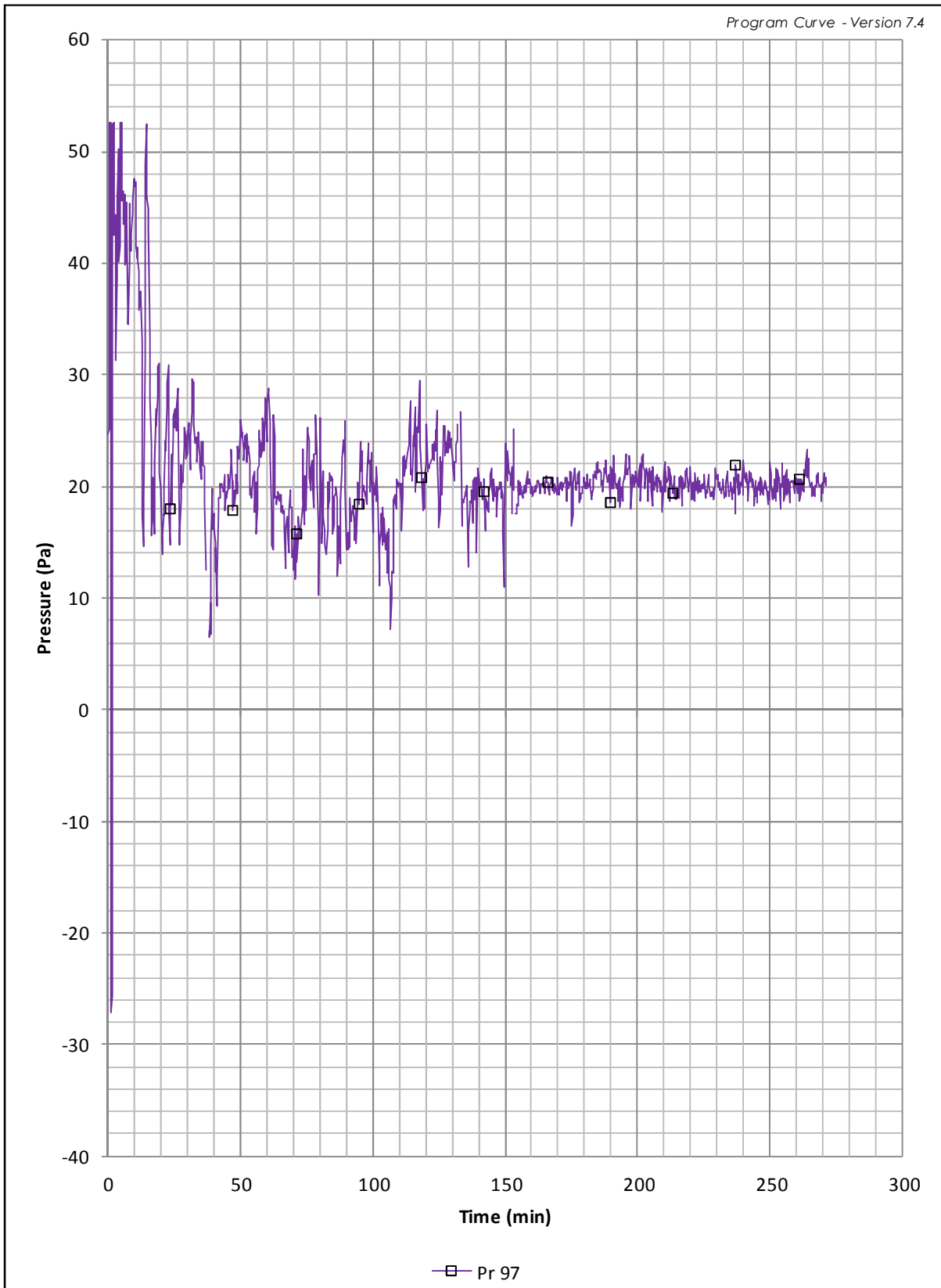

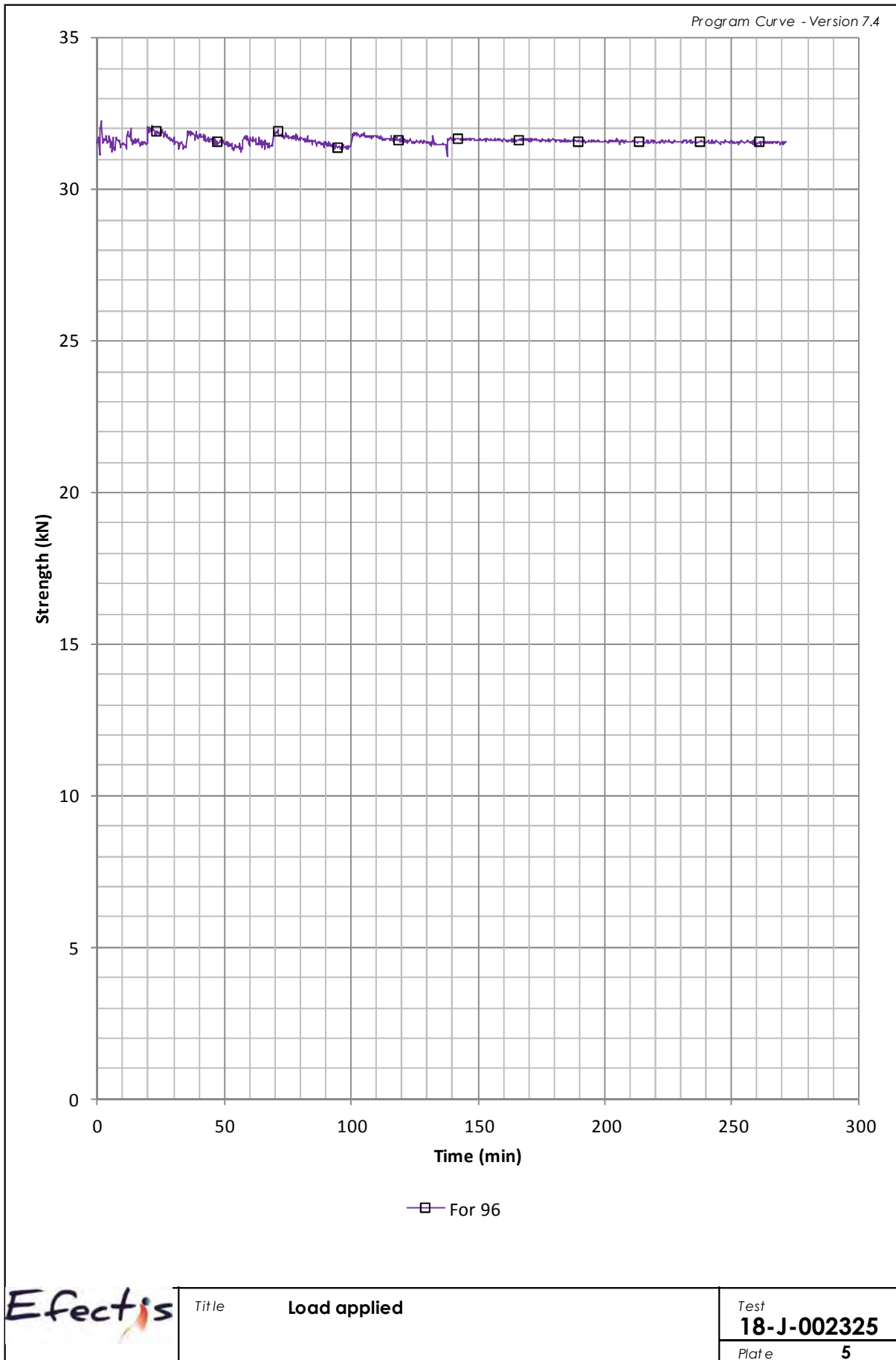

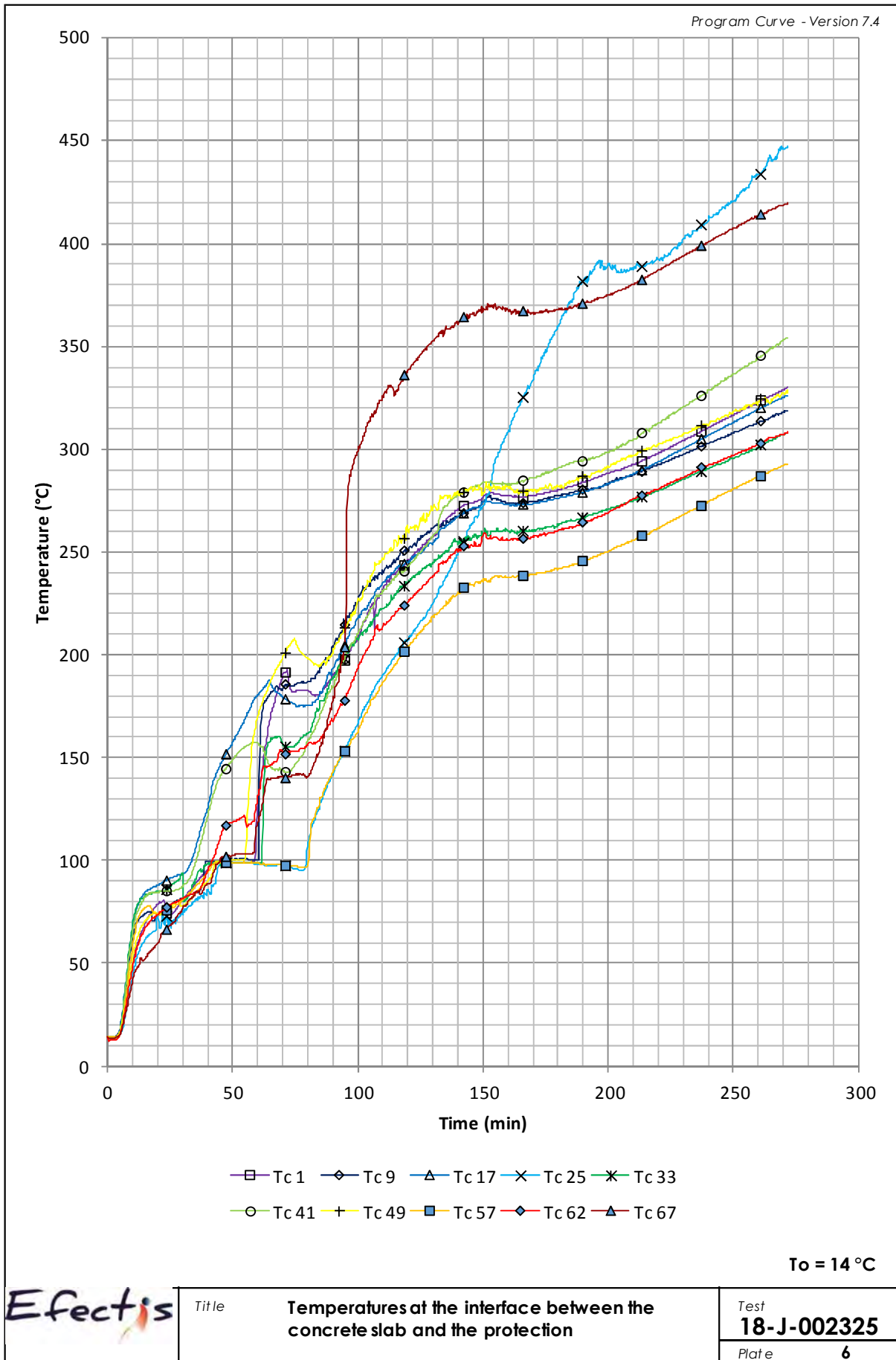

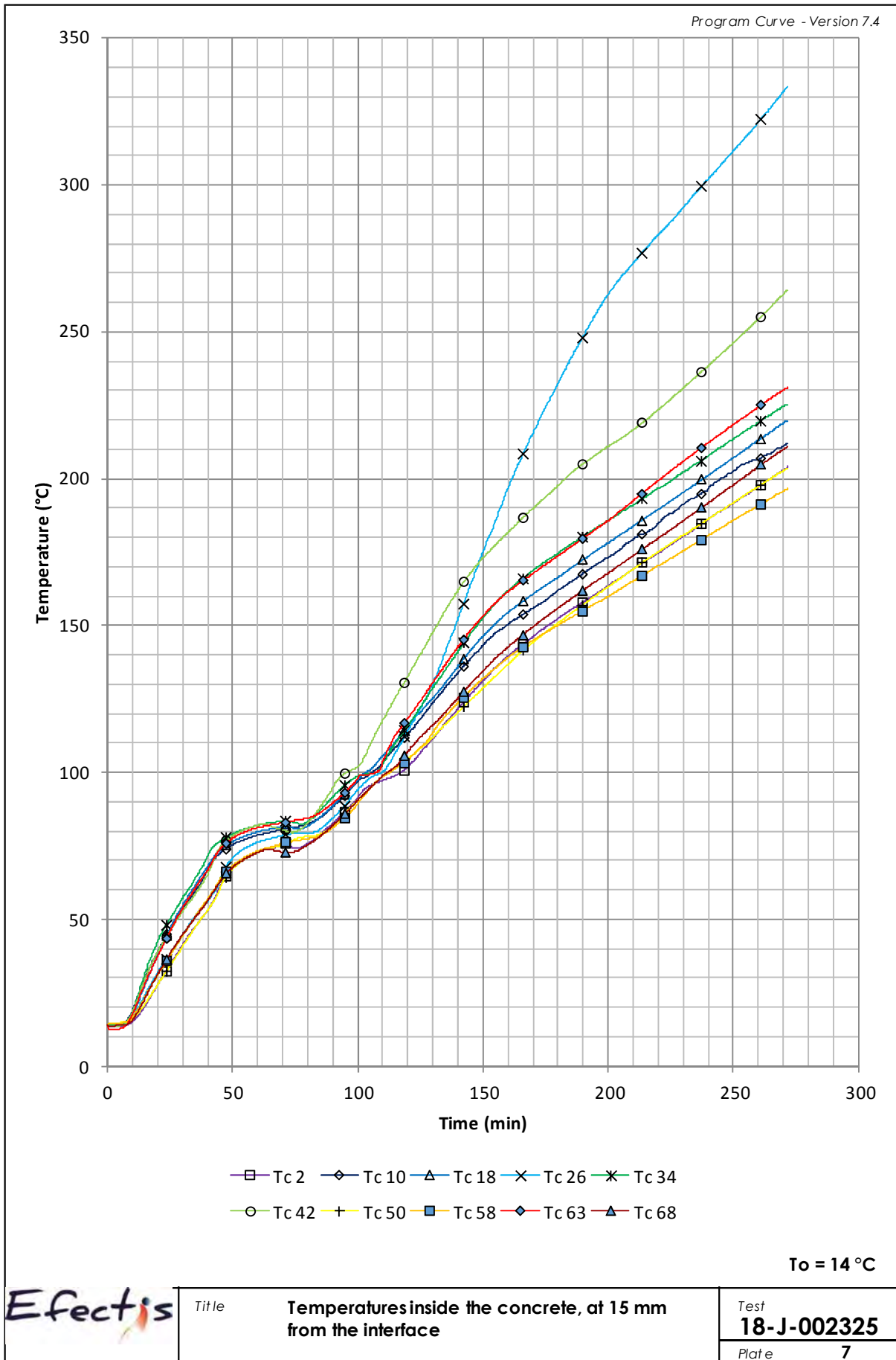

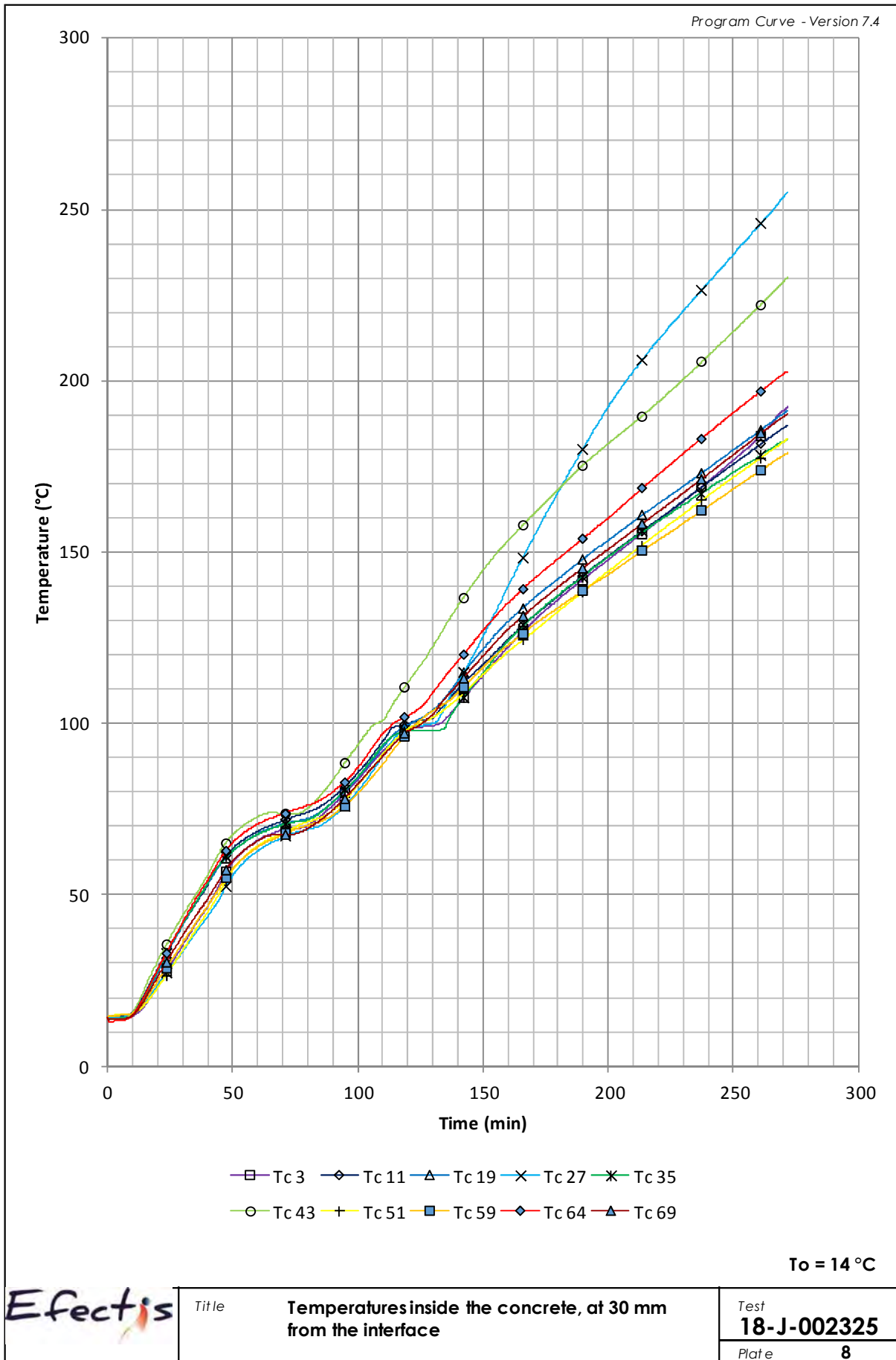

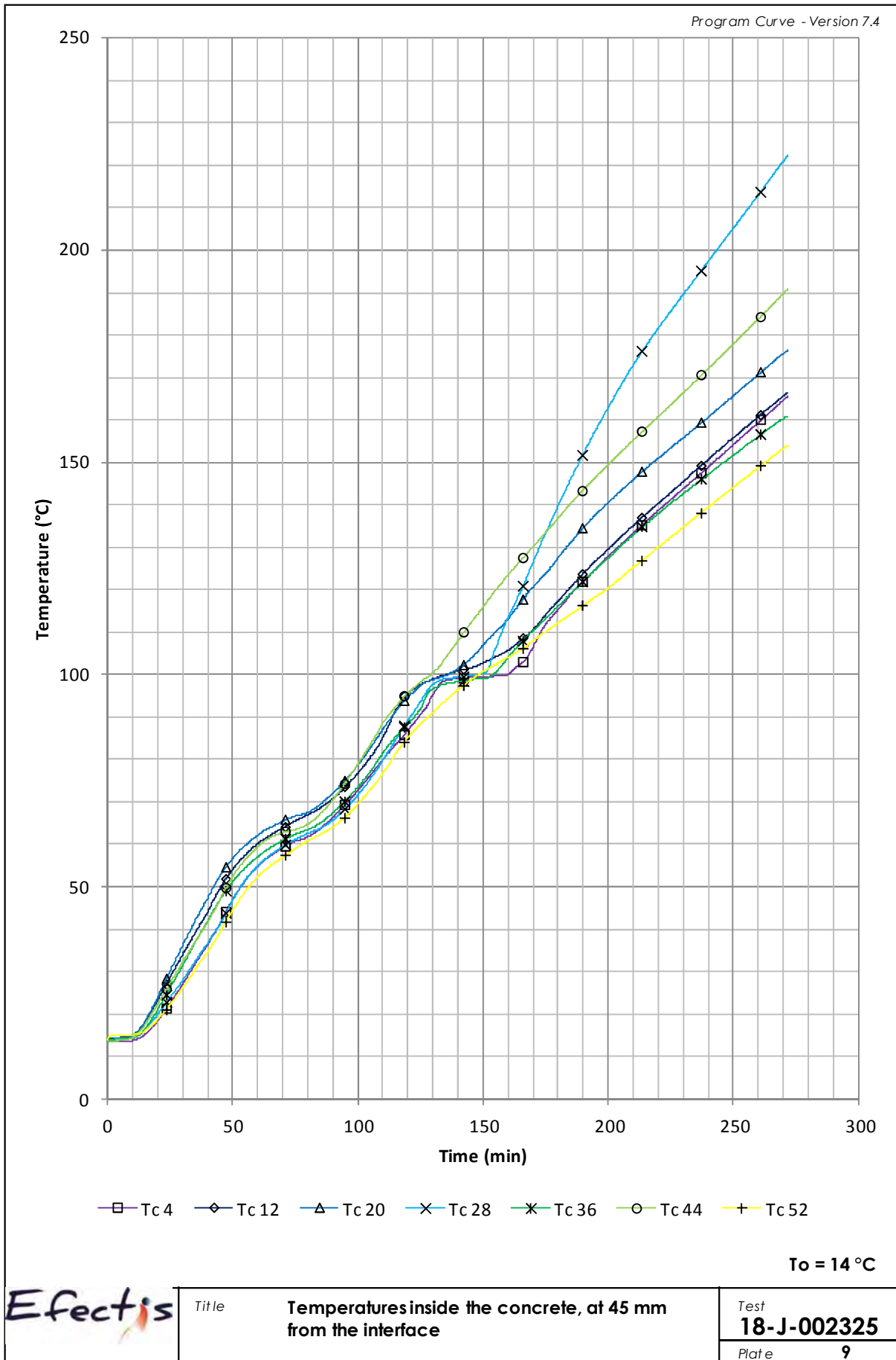



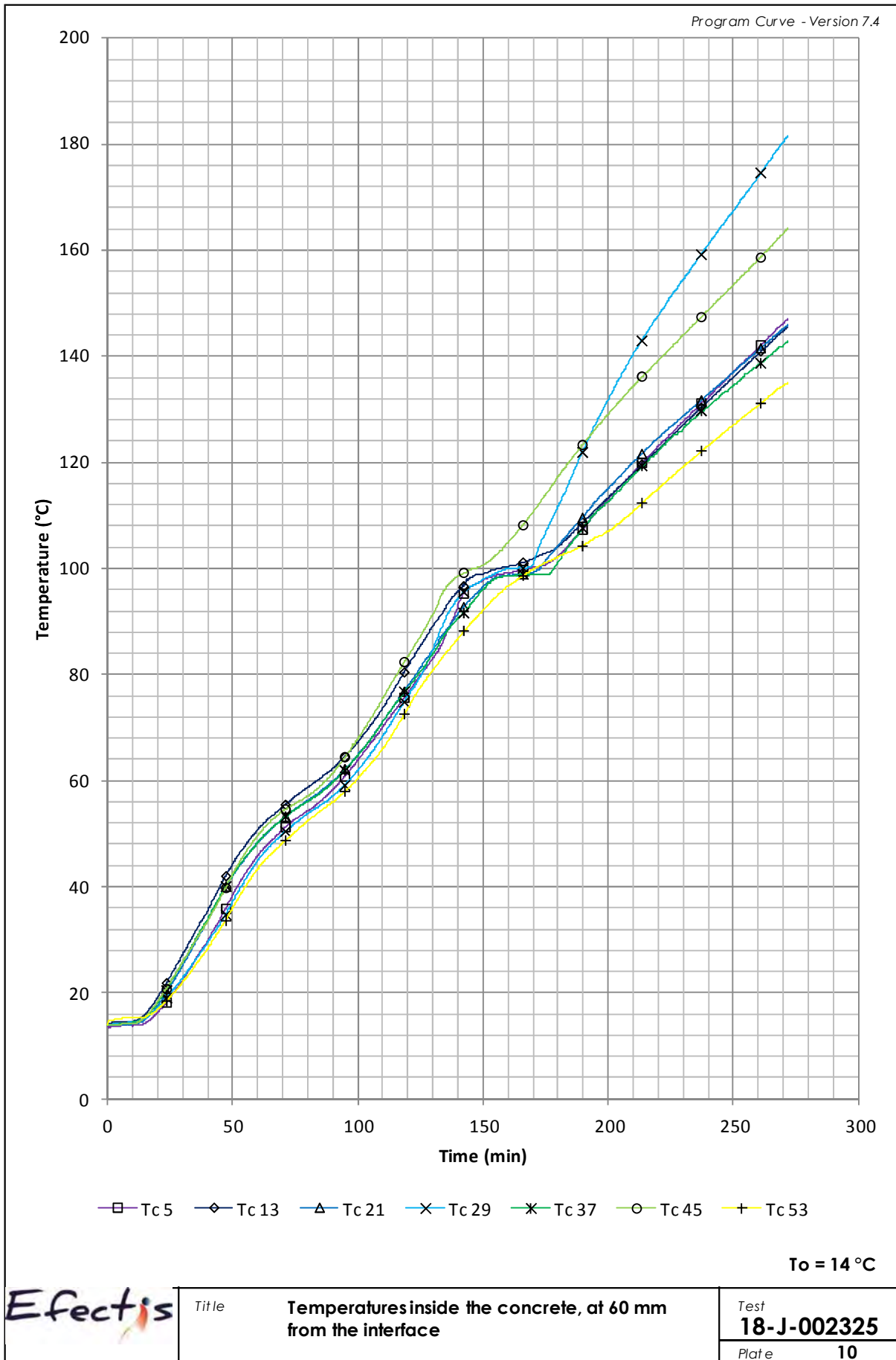

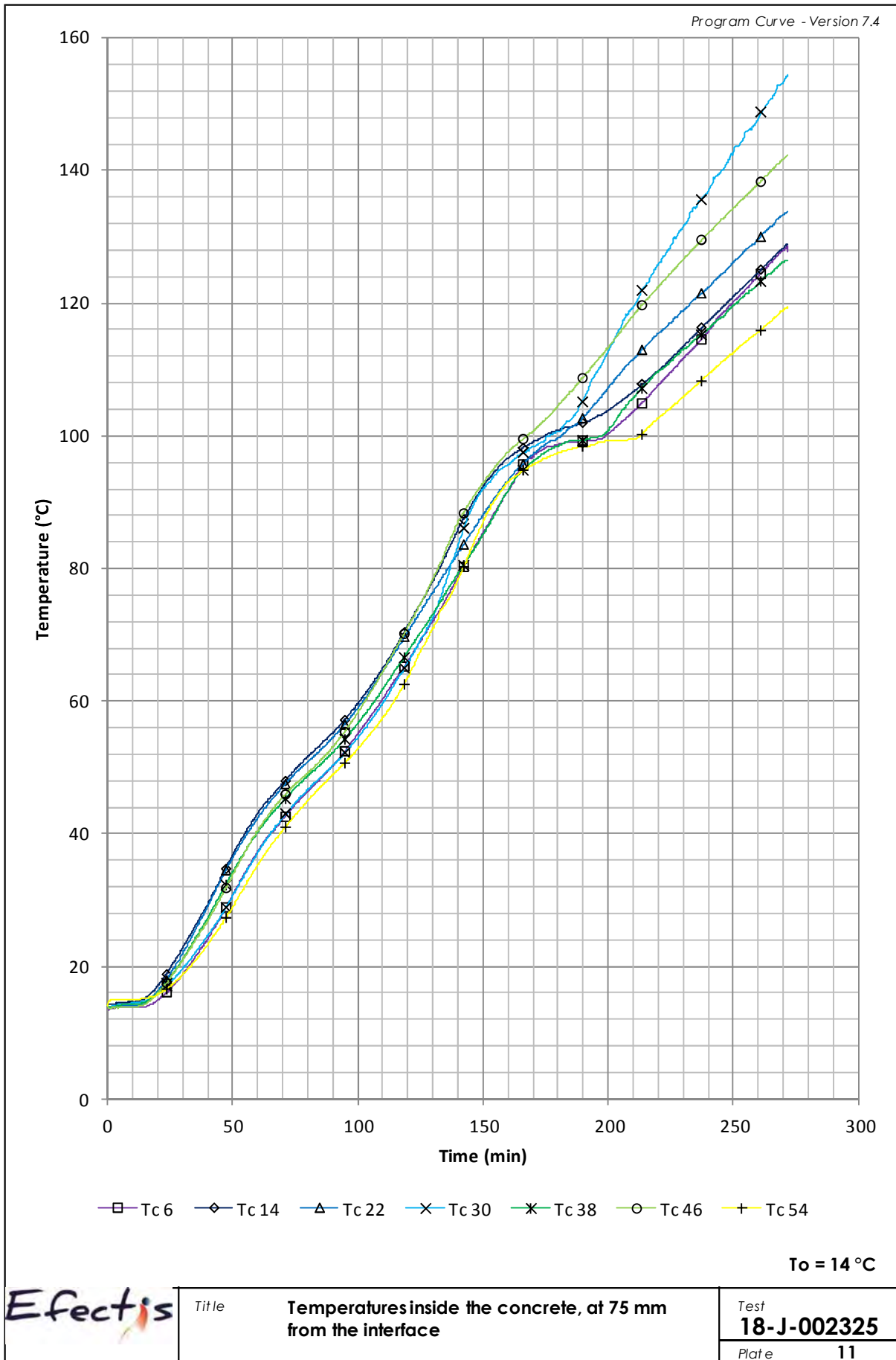

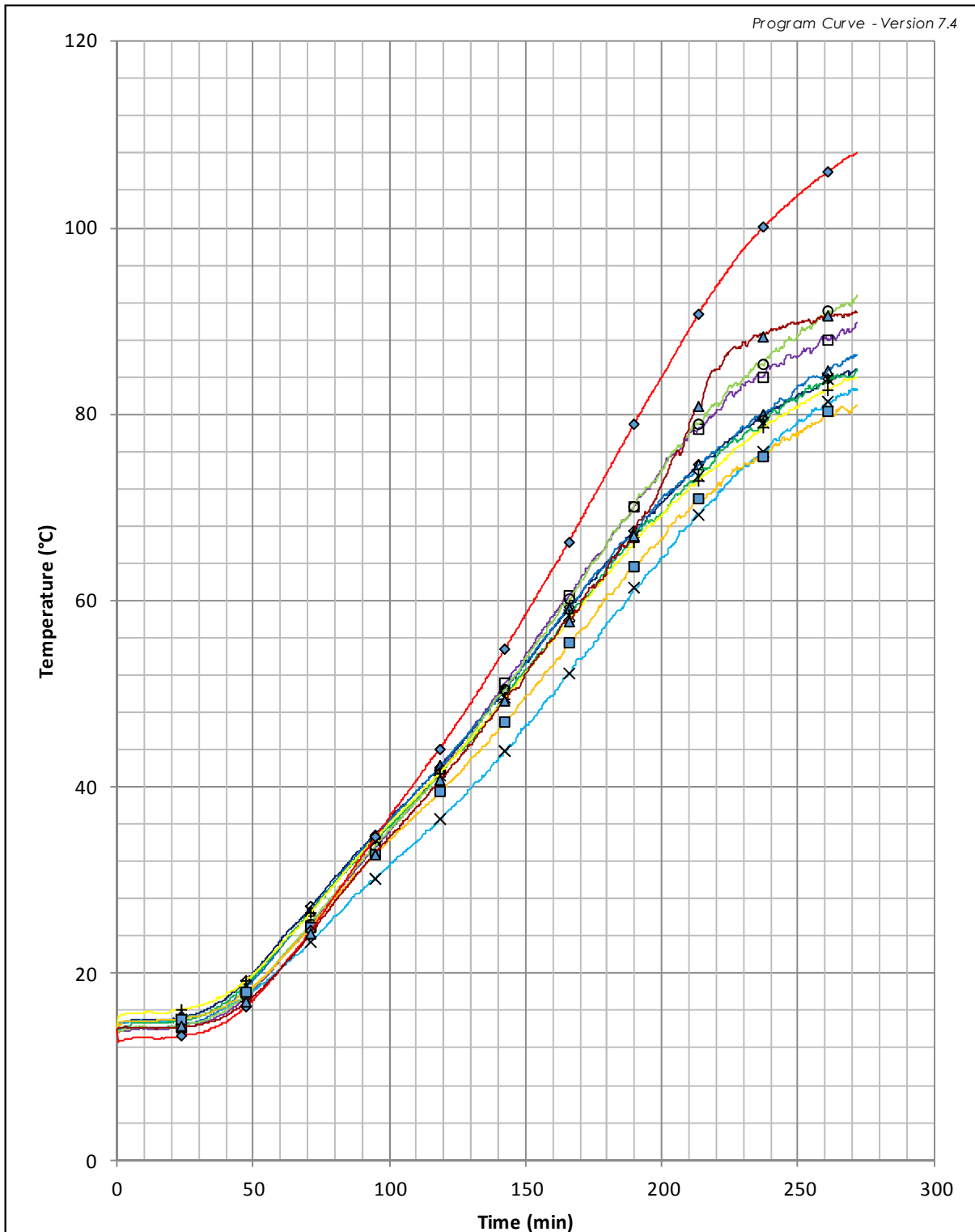

Tc 7   
  Tc 15   
  Tc 23   
  Tc 31   
  Tc 39  
 Tc 47   
  Tc 55   
  Tc 60   
  Tc 65   
  Tc 70

To = 14 °C

	Title	<b>Temperatures on the unexposed side of the concrete slab</b>	Test <b>18-J-002325</b>
			Plate <b>12</b>

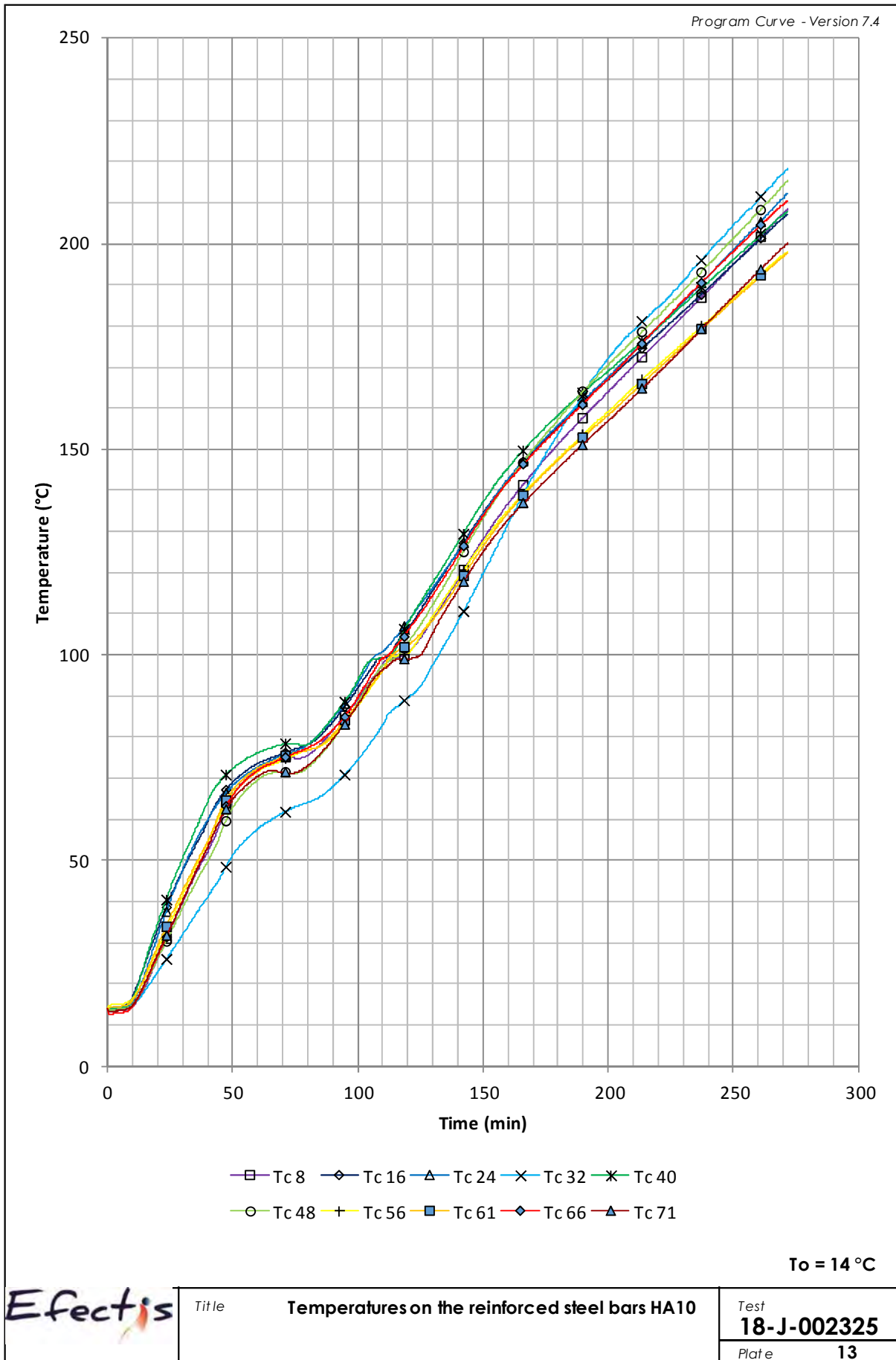

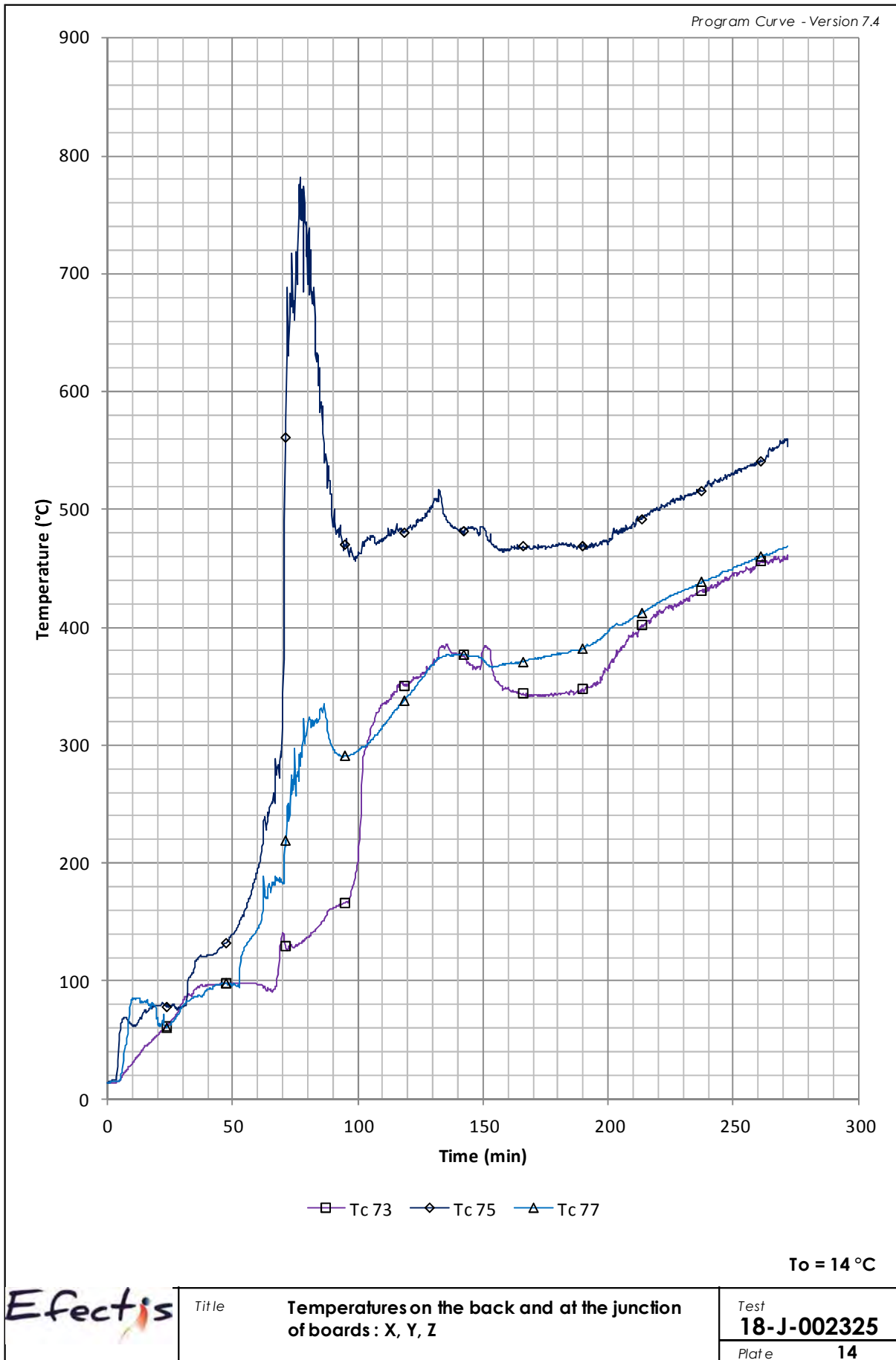

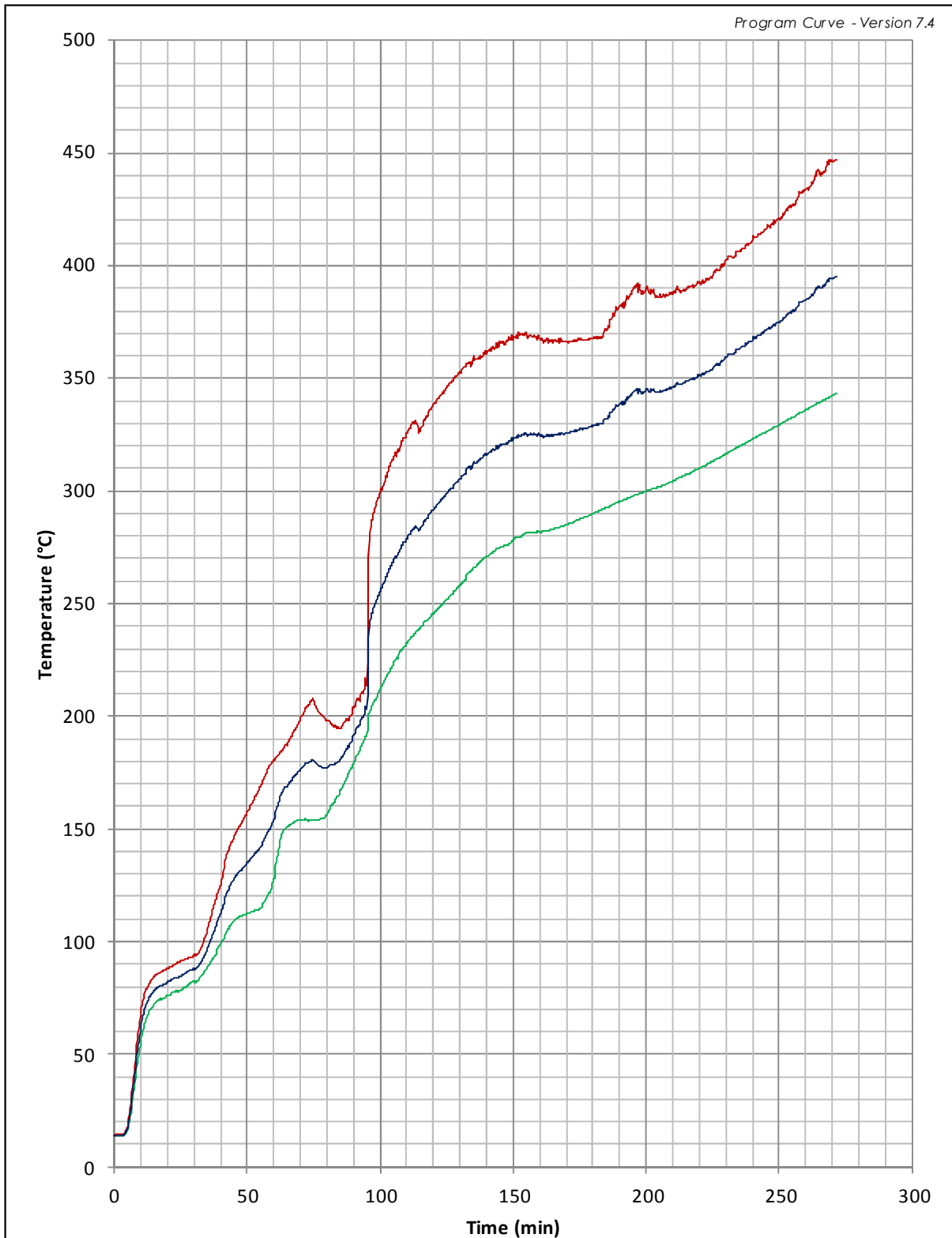

— Average — Maximal — Characteristic

To = 14 °C

	Title <b>Characteristic temperatures at the interface between the concrete slab and the protection</b>	Test <b>18-J-002325</b>
		Plate <b>15</b>

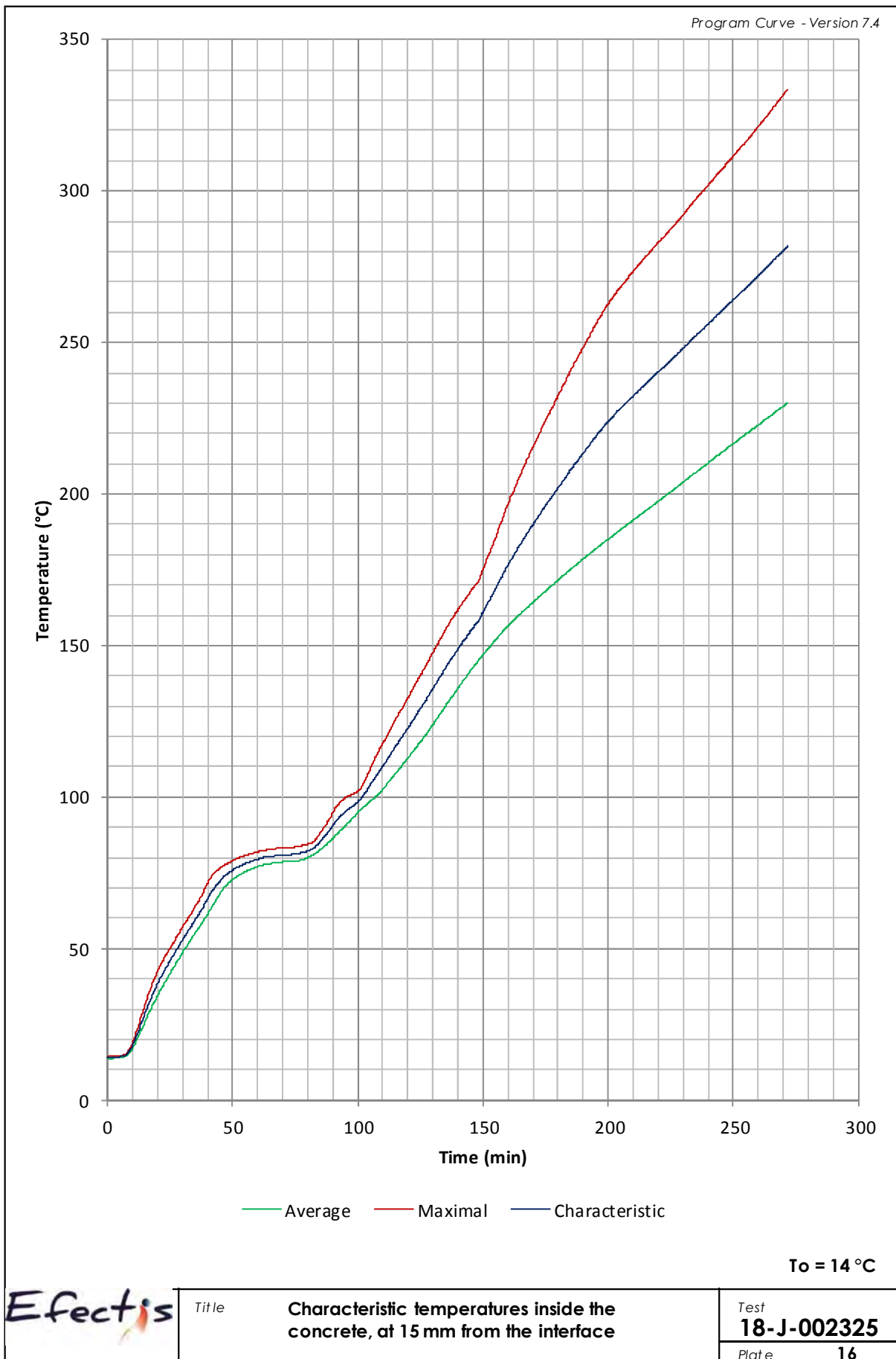

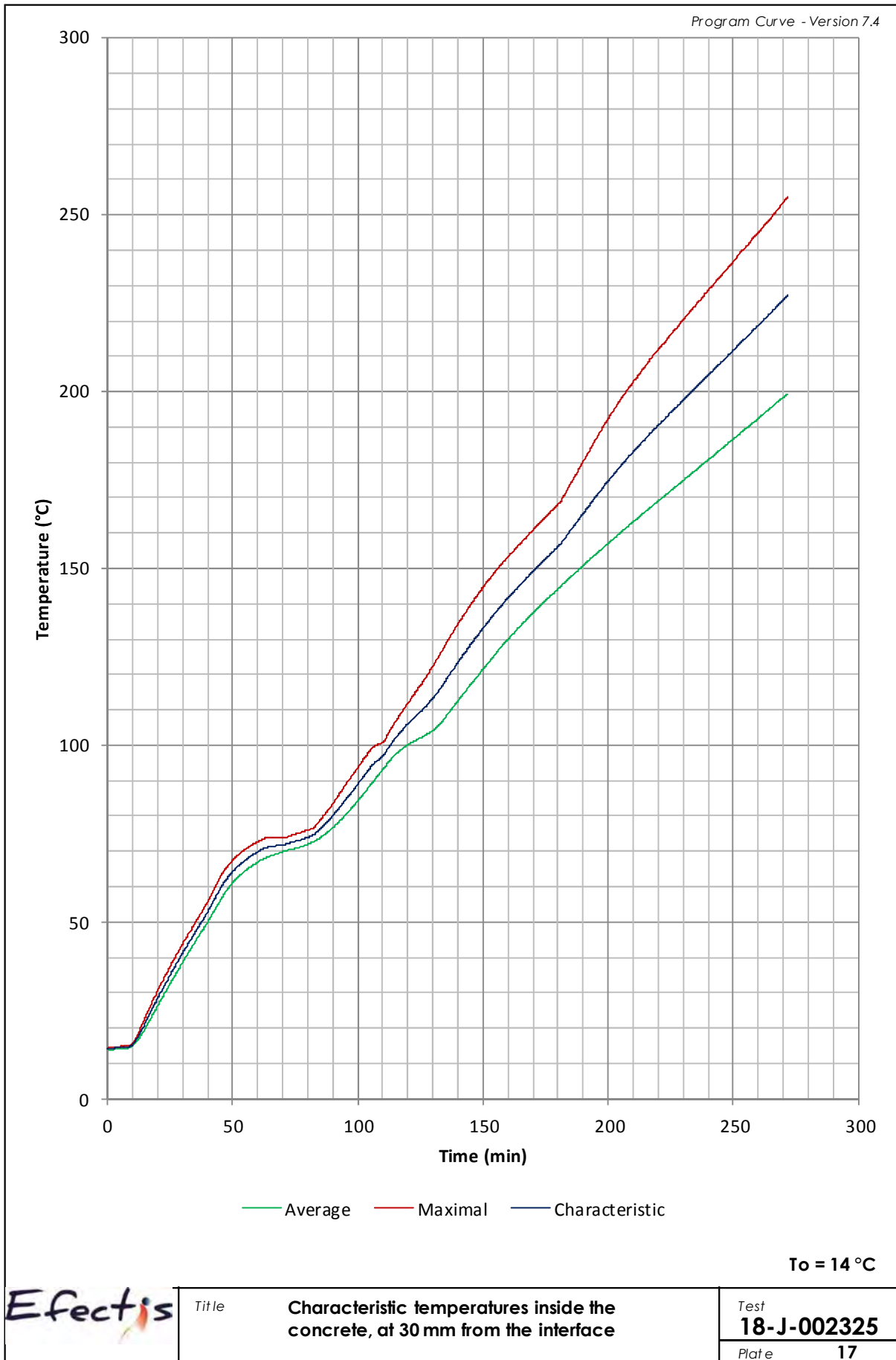



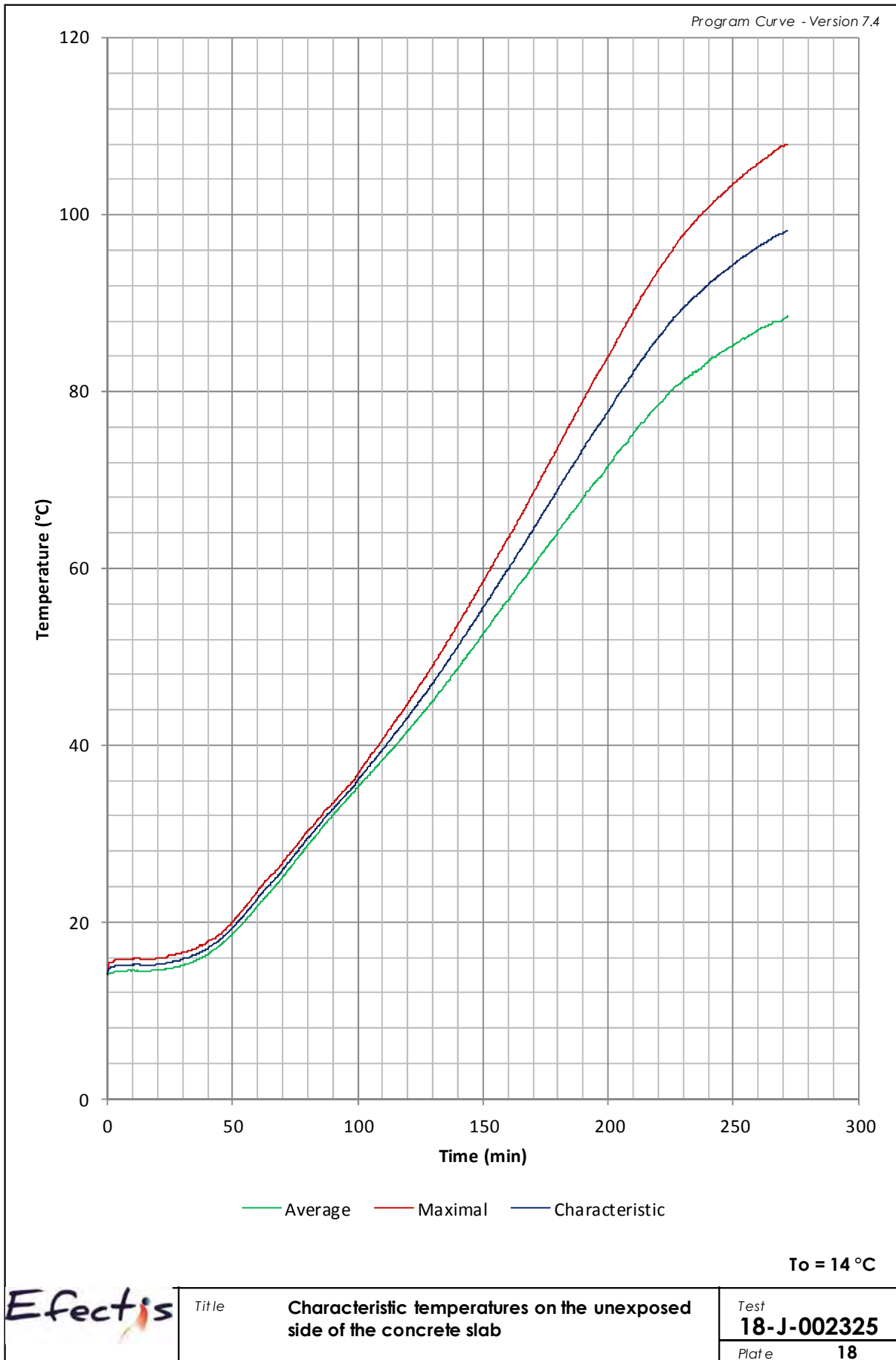

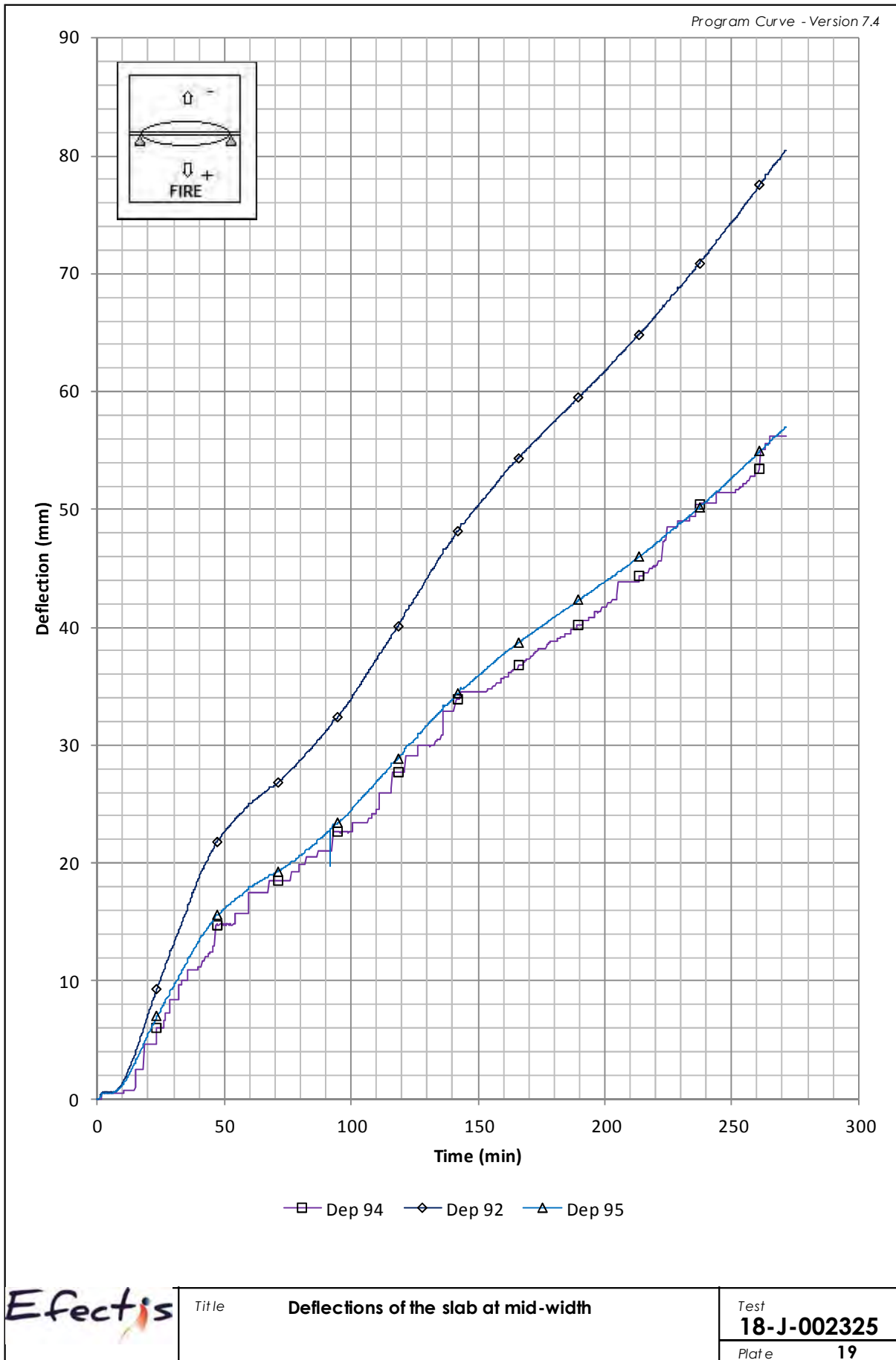

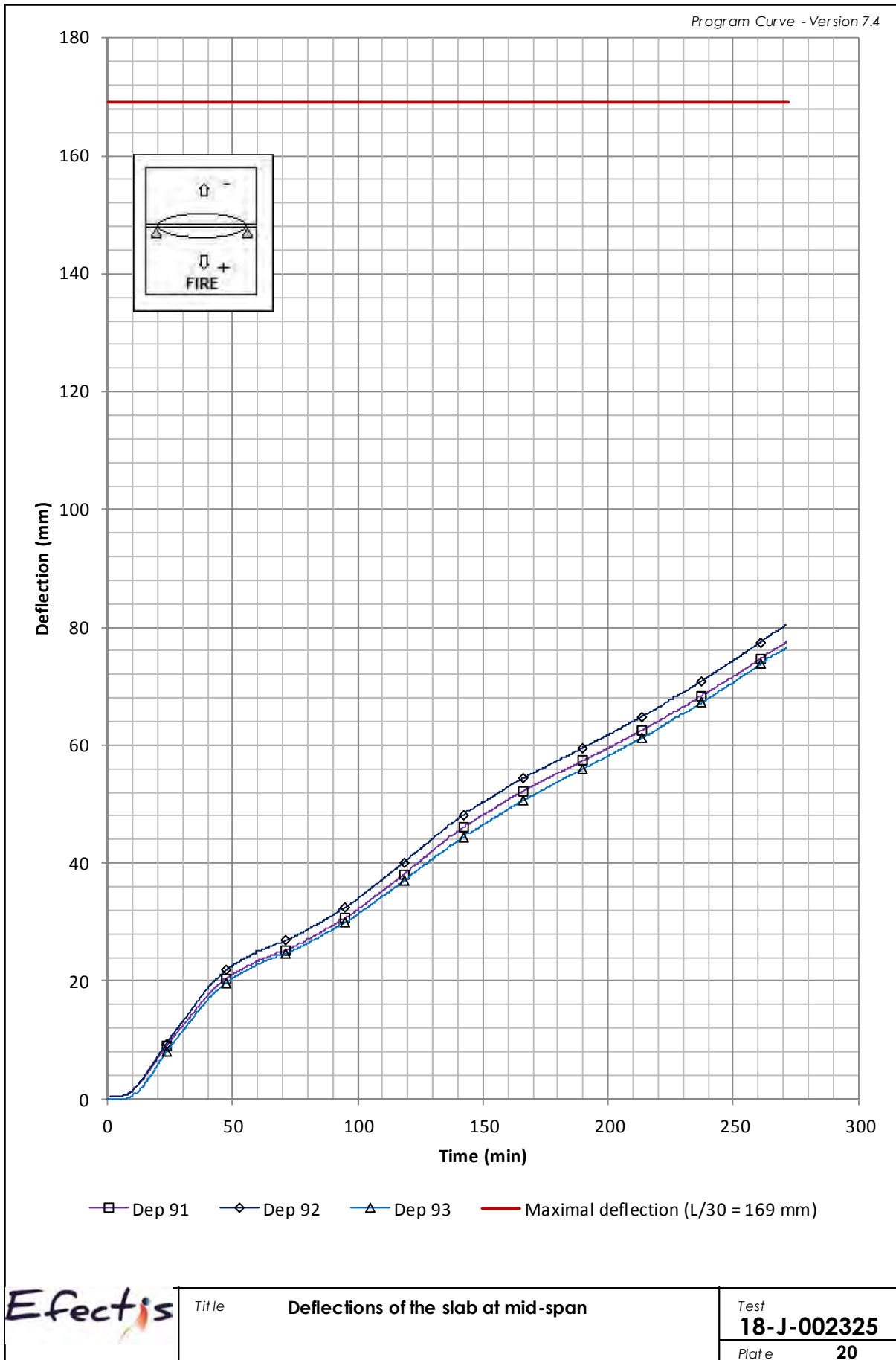

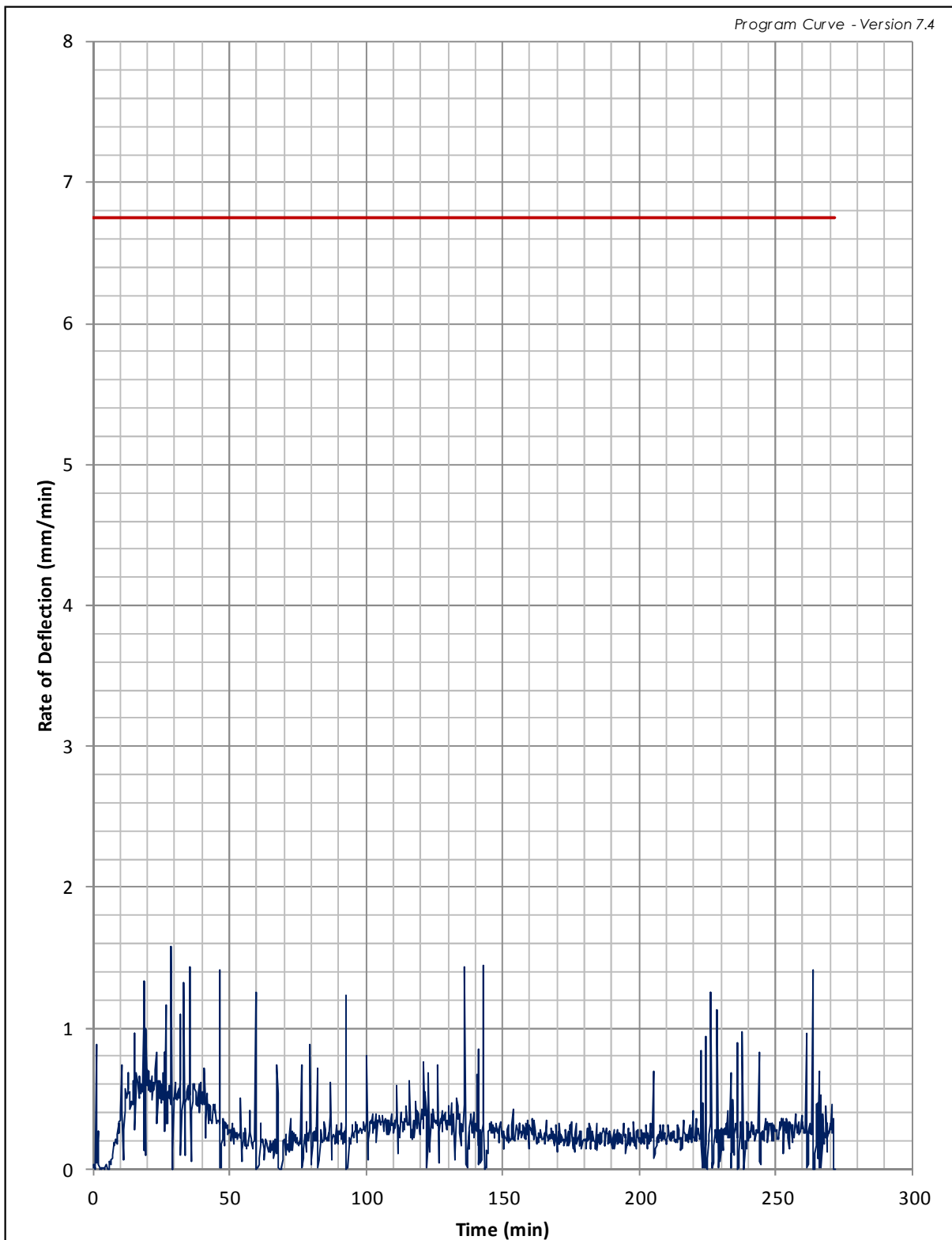



— Rate of deflection      — Maximal rate of deflection (6,75 mm/min)

	Title	Rate of Deflection of the slab at mid-span	Test	18-J-002325
			Plate	21

APPENDIX: PHOTOGRAPHS



<b>Photo A (up)</b>	Photo of the thermocouple on the exposed side of the slab - Section S1.
<b>Photo B (down)</b>	Photo of the thermocouple on the exposed side of the slab - Section S2.



<b>Photo C (up)</b>	Photo of the thermocouple on the exposed side of the slab - Section S3.
<b>Photo D (down)</b>	Photo of the thermocouple on the exposed side of the slab - Section S4.





<b>Photo E (up)</b>	Photo of the thermocouple on the exposed side of the slab - Section S5.
<b>Photo F (down)</b>	Photo of the thermocouple on the exposed side of the slab - Section S6.

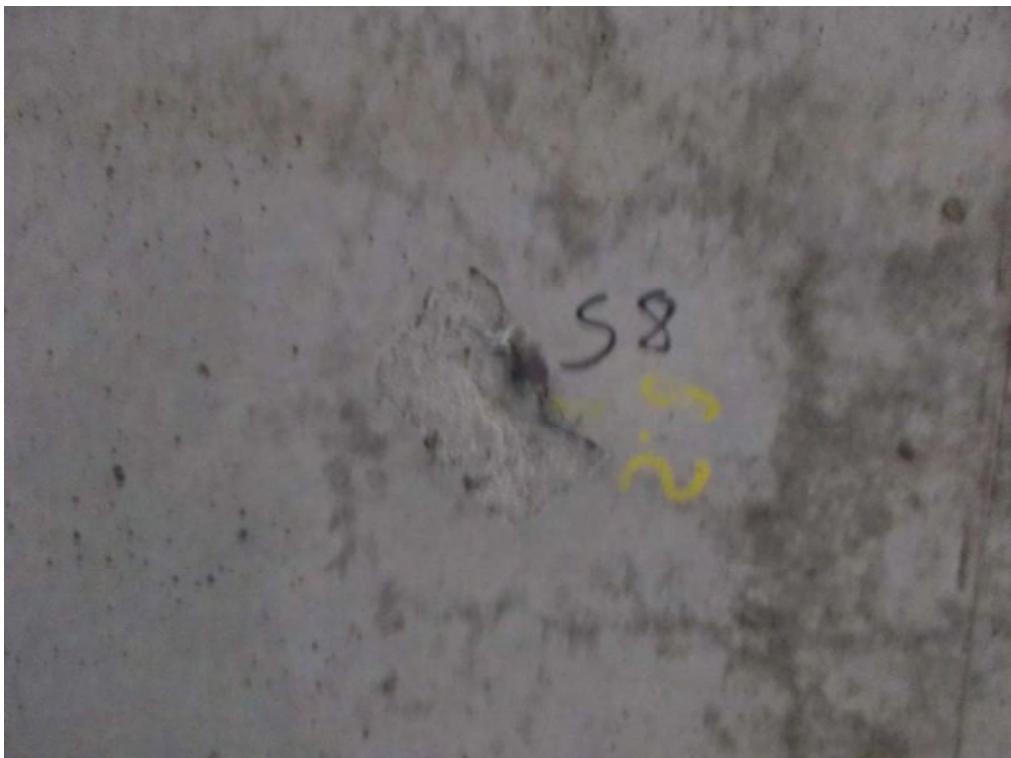

<b>Photo G (up)</b>	Photo of the thermocouple on the exposed side of the slab - Section S7.
<b>Photo H (down)</b>	Photo of the thermocouple on the exposed side of the slab - Section S8.





<b>Photo I (up)</b>	Photo of the thermocouple on the exposed side of the slab - Section S9.
<b>Photo J (down)</b>	Photo of the thermocouple on the exposed side of the slab - Section S10.



<b>Photo K</b>	Exposed side before the start of the test.
----------------	--



**Photo L** Exposed side after the test and cooling down.

## FIRE TEST REPORT EFR-18-J-004839 A

Inspired by EN 1363-1: 2012, EN 13381-3: 2015 standards and the French guide issued by CETU (Centre d'Etudes des Tunnels): "Passive fire protection systems", march 2017

<b>Test</b>	EFR-18-J-004839
<b>Performed on</b>	April 17 <sup>th</sup> , 2019
<b>Regarding</b>	<p>Research test on a passive protection applied on a concrete slab of overall dimensions 2200 x 1000 x 400 mm (L x W x Th). A simple board was installed on exposed side of concrete slab with 11 mechanical anchors.</p> <ul style="list-style-type: none"><li>▪ Trade reference of the board: AESTUVER TX</li><li>▪ Thickness of the board: 50 mm</li><li>▪ Trade reference of the anchors: HFB-R 6x85</li></ul>
<b>Sponsor</b>	<p>HILTI CORPORATION FeldkircherStrasse 100 9494 SCHAAN LIECHTENSTEIN</p>

## 1. SCOPE OF THIS TEST REPORT

---

Fire resistance test of a concrete slab protected by a protective system according to a method inspired by the standard EN 1363-1: 2012, EN 13381-3: 2015 and the French guide issued by CETU (Centre d'Etudes des Tunnels): "Passive fire protection systems", march 2017.

## 2. TEST LABORATORY

---

EFFECTIS FRANCE  
149, route du Marc  
F - 38630 LES AVENIÈRES VEYRINS-THUELIN

## 3. REFERENCE AND MANUFACTURER OF THE TESTED SPECIMEN

---

### Protective system:

Reference: AESTUVER TX  
Manufacturer: FERMACELL GmbH  
39240 CALBE  
GERMANY

### Anchors:

Reference: HFB-R 6x85  
Manufacturer: HILTI CORPORATION  
FeldkircherStrasse 100  
9494 SCHAAN  
LIECHTENSTEIN

## 4. FURTHER INFORMATION FOR CE MARKING

---

*(Chapter not covered under the COFRAC's accreditation).*

The tested element has not been collected

## 5. DESCRIPTION OF THE TESTED SPECIMEN

---

**The information below were provided by the applicant who attests their accuracy.**

### 5.1. GENERAL

The tested specimen was a concrete slab protected on its exposed side by a protective board AESTUVER TX (FERMACELL) of thickness 50 mm.

The board was fixed directly on the slab with mechanical anchors type concrete screw HFB-R Ø 6 x 85 mm (HILTI).

The dimensions were:

- Overall dimensions of the slab : 2200 x 1000 x 400 mm (L x W x Th)
- Protected area : 1900 x 1000 mm (L x W)
- Exposed area : 1900 x 1000 mm (L x W).

**5.2. LIST OF THE COMPONENTS**

According to the information supplied by the Sponsor.

Name	Trade reference	Material	Characteristics	Supplier
Board	AESTUVER TX	Cement bonded system	Th = 50 mm d = 680-800 kg/m <sup>3</sup>	FERMACELL
Anchor	HFB-R	Stainless steel	Ø 6 x 85 mm	HILTI
Washer *	-	Stainless steel	Ø 6.5 x 30 mm	

Th = thickness --- d = density --- Ø = diameter

\* Washer was delivered with the anchor.

**5.3. DETAILED DESCRIPTION OF THE SPECIMEN**

5.3.1. Concrete slab

Characteristics	Datas
Overall dimensions	2200 x 1000 x 400 mm (L x W x Th)
Concrete strength class	C 25 / 30
Aggregates	Silicious
Reinforcing bars	According to EN 13381-3: 2015
Date of casting	21 <sup>th</sup> February 2019
Density measured	2223 kg/m <sup>3</sup>

5.3.2. Protective board

The drawing in the appendix n° 1 have been supplied by the Sponsor.

A simple board AESTUVER TX (FERMACELL) was installed on exposed side of concrete slab (see photo A). No surface preparation of the concrete slab was undertaken prior to installation of board. The dimensions of the board were 1900 x 1000 mm (L x W) and thickness 50 mm.

The board was fixed on the slab with 11 mechanical anchors type concrete screw HFB-R Ø 6 x 85 mm (HILTI). The location of anchors are reported in the appendix n° 1. The anchors were previously equipped with washers made of stainless steel dimensions Ø 6.5 x 30 mm and thickness 1.5 mm.

**5.4. VERIFICATION**

The laboratory performed a detailed examination of the test item prior to testing and verified the accuracy of the information provided.



## 6. TEST ASSEMBLY

---

### 6.1. DEFINITION OF THE TESTED SPECIMEN

The choice and the definition of this test specimen have been carried out by the Sponsor.

### 6.2. ASSEMBLY OF THE TESTED SPECIMEN

#### 6.2.1. Test mounting

The concrete slab was installed on the furnace structure and was exposed on 1900 x 1000 mm (L x W) area.

#### 6.2.2. Staff

The concrete slab had been casted by the staff of the test laboratory.

The installation of the protective system on the concrete slab had been made by the skillful staff of the Sponsor.

## 7. TEST METHOD

---

### 7.1. PRELIMINARY CONDITIONING

The weight stability of the concrete slab was reached on the day of the test.

### 7.2. THERMAL PROGRAM

The temperature rise inside the furnace above the ambient temperature was controlled according to the **RWS thermal program** according to the Sponsor's request, represented by the following table:

<i>Time (minutes)</i>	<i>Temperature (°C)</i>
0	20
3	890
5	1140
10	1200
30	1300
60	1350
90	1300

Then, after 90 minutes of RWS thermal program, the temperature inside the furnace above the ambient temperature was controlled according to the **Majorated Hydrocarbon Curve (HCM)**, represented by the following function:

$$T = 1280 (1 - 0,325 e^{-0.167 t} - 0,675 e^{-2.5 t}) + 20$$

Then, after 132 minutes (120 minutes + 10%) of RWS + HCM program, the temperature inside the furnace above the ambient temperature was controlled until the end of the test according to the **standard thermal program**, represented by the following function:

$$T = 345 \log_{10} (8t+1) + 20$$

where:

$t$  = Time (min)

$T$  = Furnace temperature at time  $t$  (°C).

**7.3. AMBIENT PRESSURE**

According to paragraph A.10 of the guide, no pressure order was followed because the pressure is considered as an uninfluential factor on the test results.

**8. MEASUREMENTS DURING THE FIRE TEST AND TEST RESULTS**

The location of the thermocouples are shown in appendix n° 2.

The measurement results are reported in appendix n° 3, on the plates mentioned hereafter.

**8.1. TEMPERATURE MEASUREMENTS**

8.1.1. Ambient temperature in the laboratory

The ambient temperature was measured according to the requirements of the standard EN 1363-1: 2012, by a Type K thermocouple.

<i>Location</i>	<i>Marking</i>	<i>Appendix</i>
Ambient temperature in the laboratory	Tc 11	1

8.1.2. Ambient temperature in the furnace

It was measured in conformity with the standard EN 1363-1: 2012 by 10 plate pyrometers with their metal face towards the bottom of the furnace. 4 Type S thermocouples were added for security reason.

<i>Location</i>	<i>Markings</i>	<i>Appendix</i>
Ambient temperature in the furnace, at 100 mm under the exposed face	Tc 1 to 10 Tc 40 to 43	2

8.1.3. Temperatures of the specimen

The temperatures were measured by Type K thermocouples according to the requirements of the Sponsor.

<i>Location</i>	<i>Markings</i>	<i>Appendix</i>
Temperatures at the interface between the concrete slab and the protection	Tc 12 to 13	4
Temperatures on the reinforced steel bars	Tc 28 to 29	5

**8.2. PRESSURE MEASUREMENTS**

In conformity with the requirements of the standard EN 1363-1: 2012, the pressure inside the furnace was continuously controlled throughout the whole test.

<i>Location</i>	<i>Marking</i>	<i>Appendix</i>
Ambient pressure inside the furnace, at 100 mm under the exposed face	Pr 50	3



## 9. OBSERVATIONS

---

### 9.1. BEFORE THE TEST

- Ambient temperature inside the laboratory : 15°C
- Specimen temperature before the test : 17°C.

### 9.2. DURING THE TEST

Time (min)	Observations
0	<b>Start of the fire test</b> (see photo B).
65	Appearance of cracks in the board.
90	Switching of heating program, from RWS to HCM.
132	Switching of heating program, from HCM to standard thermal program.
<b>245</b>	<b>End of the test on request of the Sponsor.</b>

### 9.3. AFTER THE TEST AND COOL DOWN

The protective system was still in place, it was cracked in several point (see photo C and D).

## 10. WARNING

---

'This report gives details about the construction method, the testing conditions and the test results achieved when the specific building element described was tested according to the procedure specified in standard EN 1363-1: 2012 and, where applicable, in standard EN 1363-2: 1999.

As concerns the dimensions, details, loading, stresses and boundary or end conditions, any significant deviation other than that which is not excluded within the field of direct application of the appropriate test procedure is not covered by this report.

Because of the nature of the fire tests and of the resulting difficulty in quantifying the uncertainty of the fire resistance assessment, it is impossible to establish any level of accuracy of the results.'

Les Avenières Veyrins-Thuellin, the 5<sup>th</sup> August 2019

  
X

---

Project Leader  
Signé par : Amélie BRUNON

  
X

---

Test Supervisor  
Signé par : Clifford CHINAYA

APPENDIX n° 1: LOCATION OF THE ANCHORS

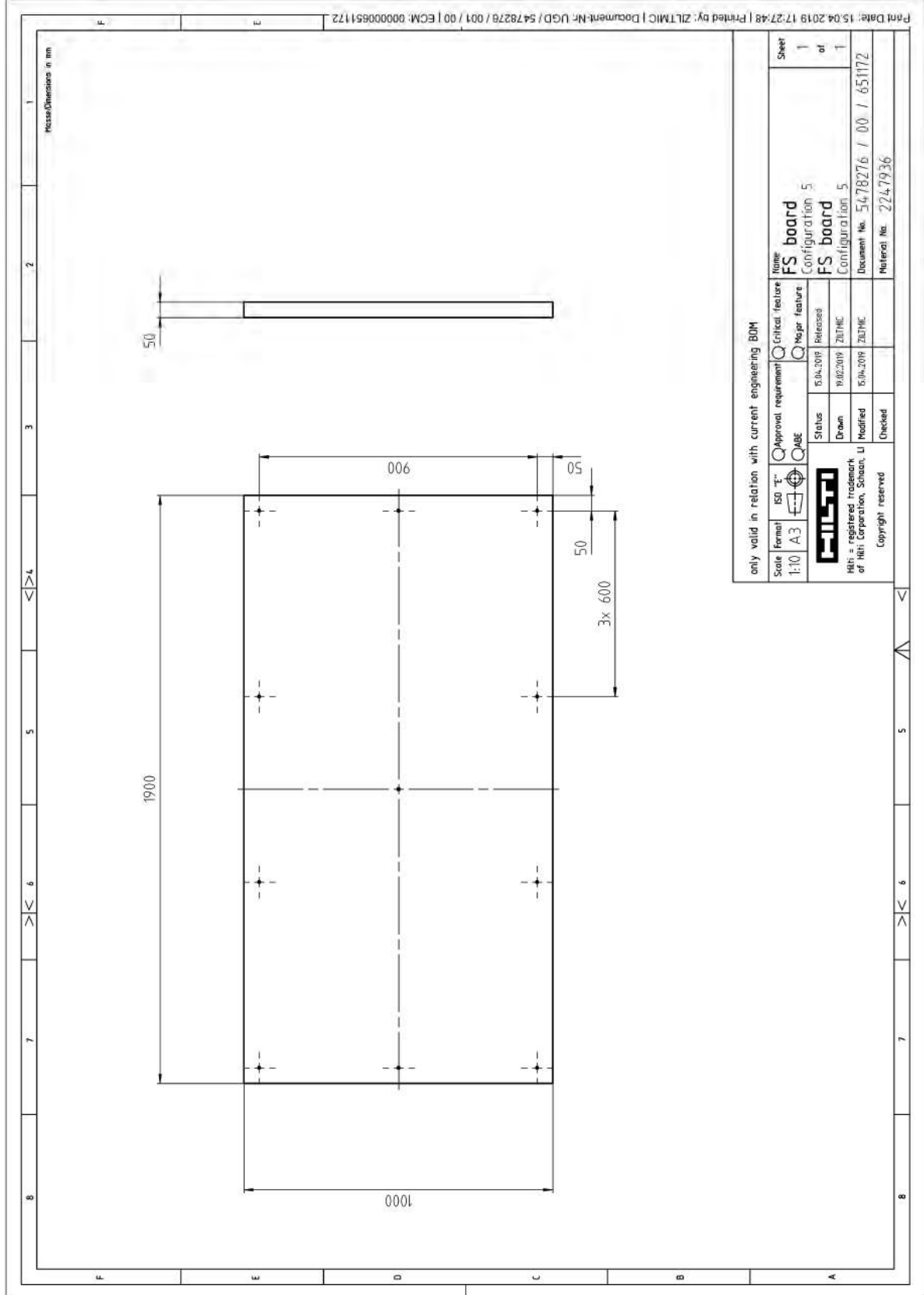

only valid in relation with current engineering BOM

Scale	Format	ISO "E"	Approval requirement	Critical feature	Frame	Sheet
1:10	A3	<input checked="" type="checkbox"/>	<input type="checkbox"/>	<input type="checkbox"/>	FS board	1 of 1
			QBE	Q	Configuration 5	
					FS board	
					Configuration 5	
					Document No. 5478276 / 00 / 651172	
					Material No. 2247936	

Status: 15.04.2019 Released  
 Drawn: 19.02.2019 ZILTMIC  
 Modified: 15.04.2019 ZILTMIC  
 Checked:

Copyright reserved  
 Hilti is registered trademark of Hilti Corporation, Schaan, LI

Print Date: 15.04.2019 17:27:48 | Printed by: ZILTMIC | Document-Nr.: UGD / 5478276 / 001 / 00 | ECM: 60000651172

APPENDIX n° 2: LOCATION OF THE THERMOCOUPLES

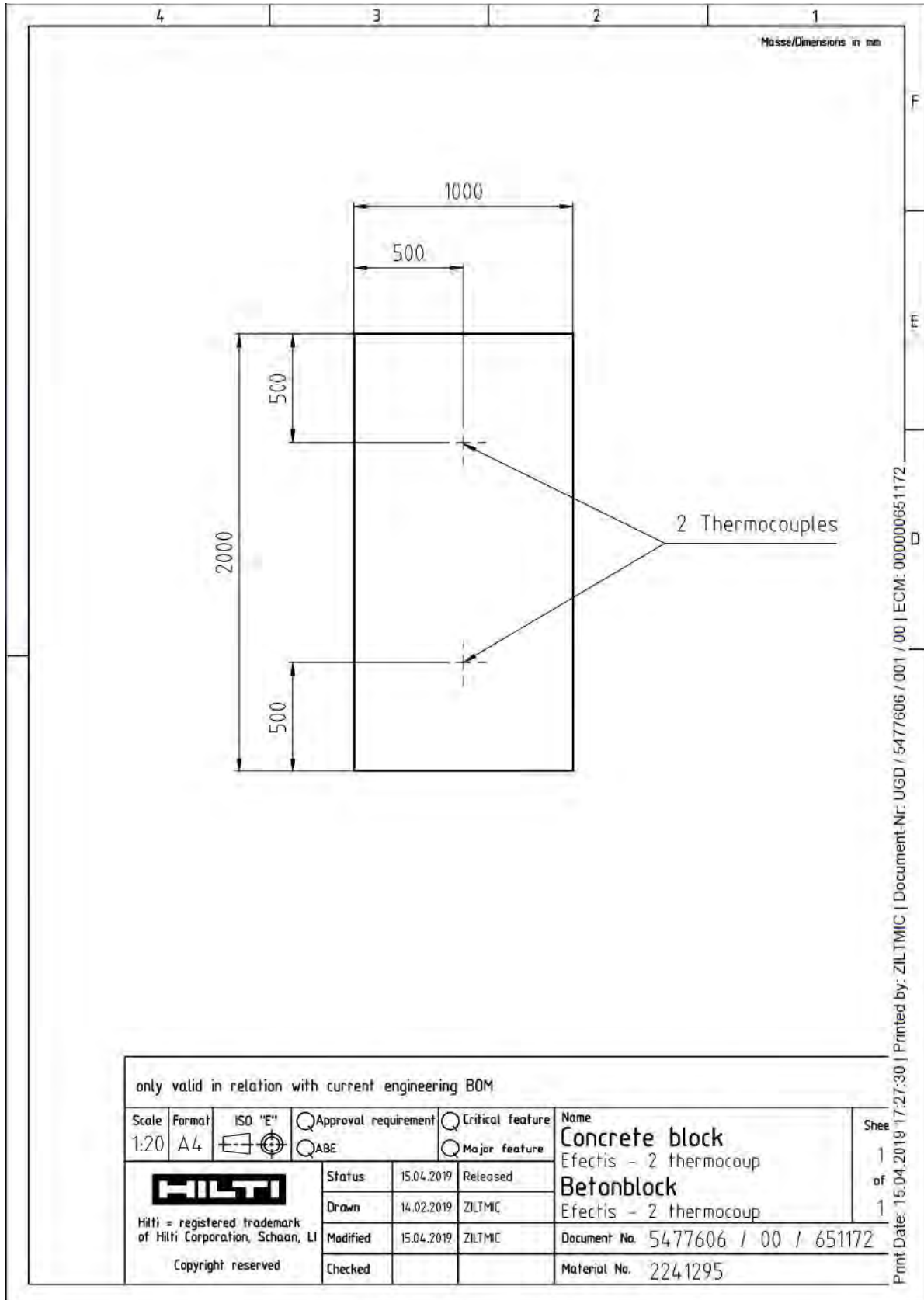

APPENDIX n° 3: CHARTS

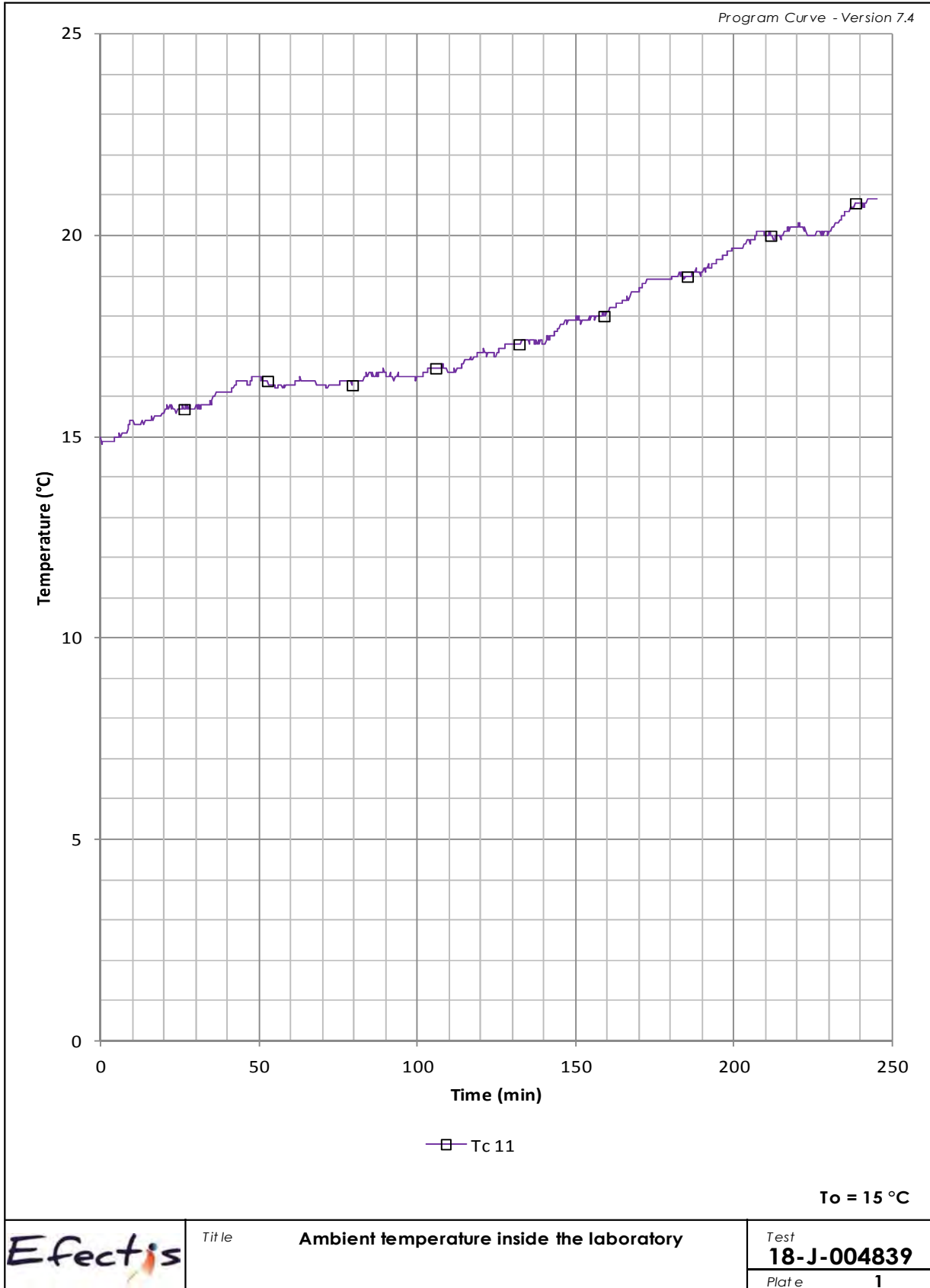

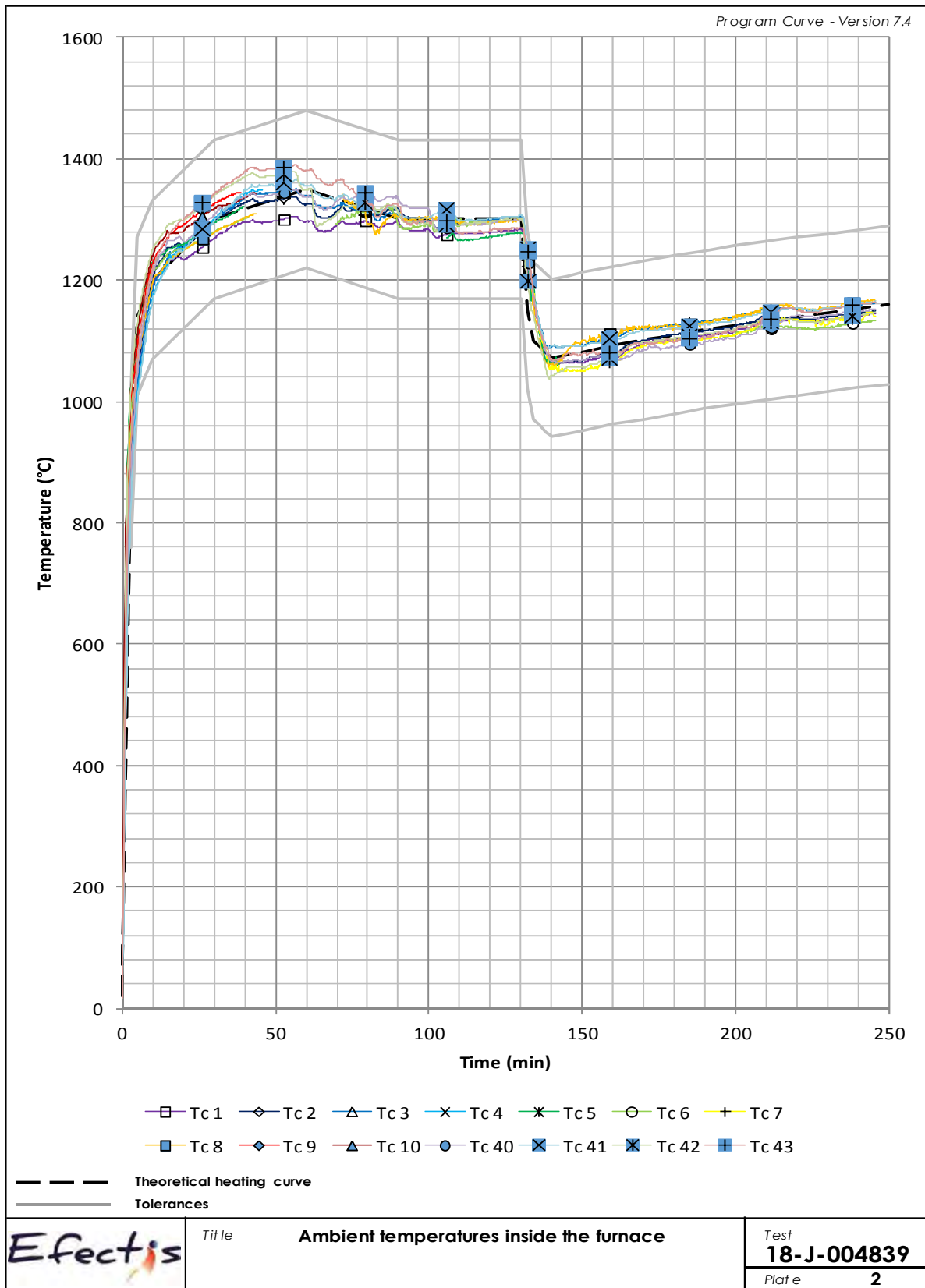

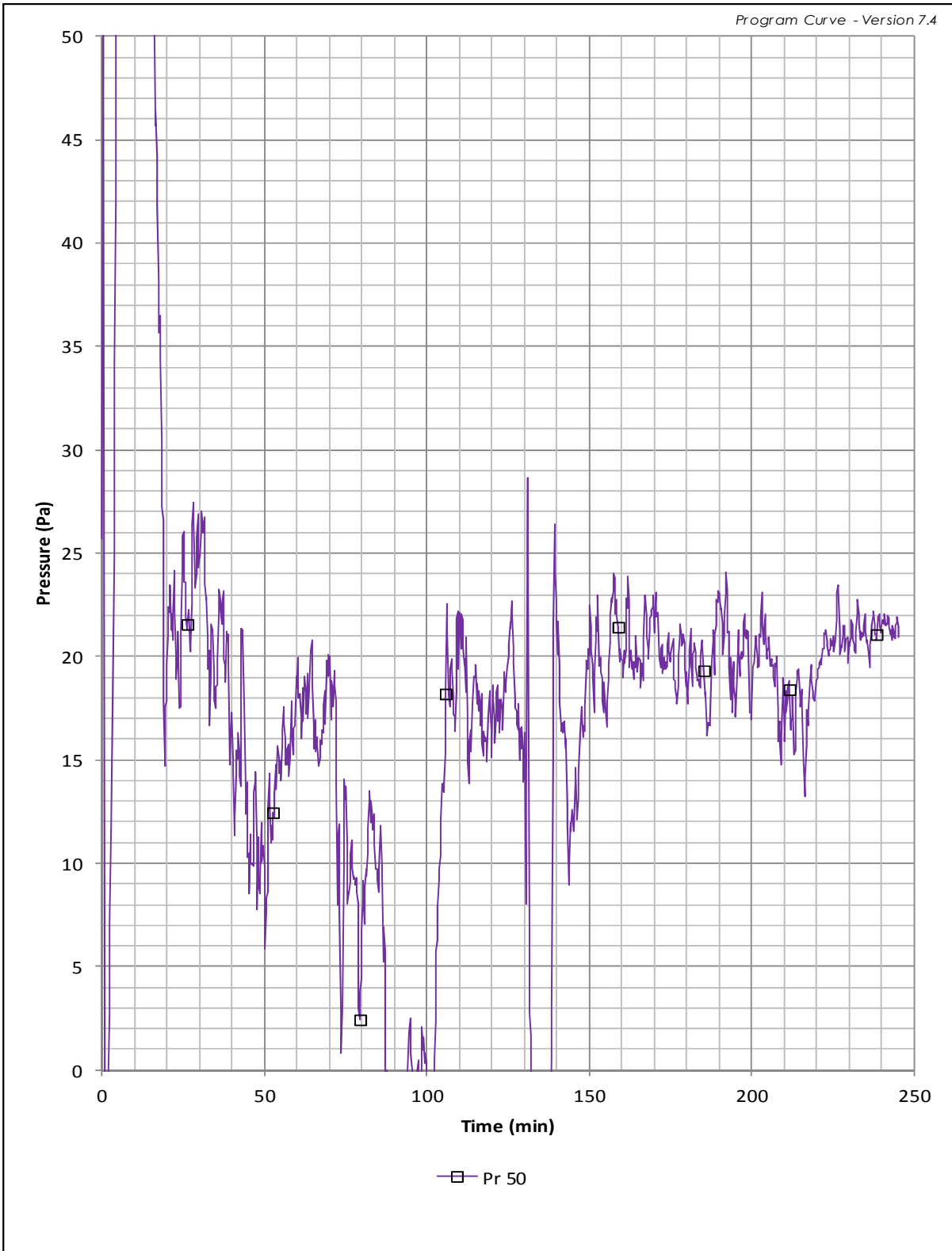

	<i>Title</i> <b>Static pressure inside the furnace</b>	<i>Test</i> <b>18-J-004839</b>
		<i>Plate</i> <b>3</b>

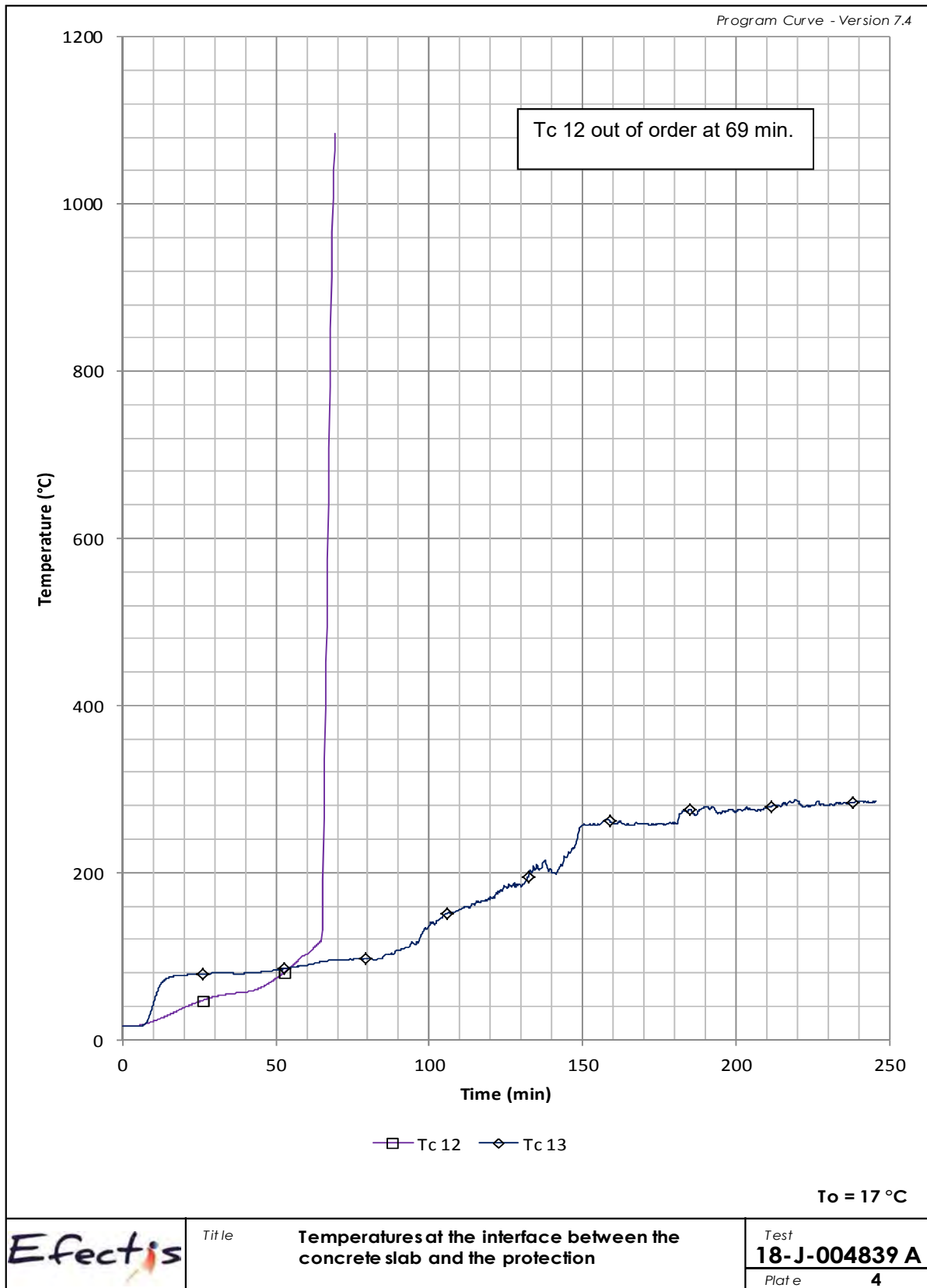

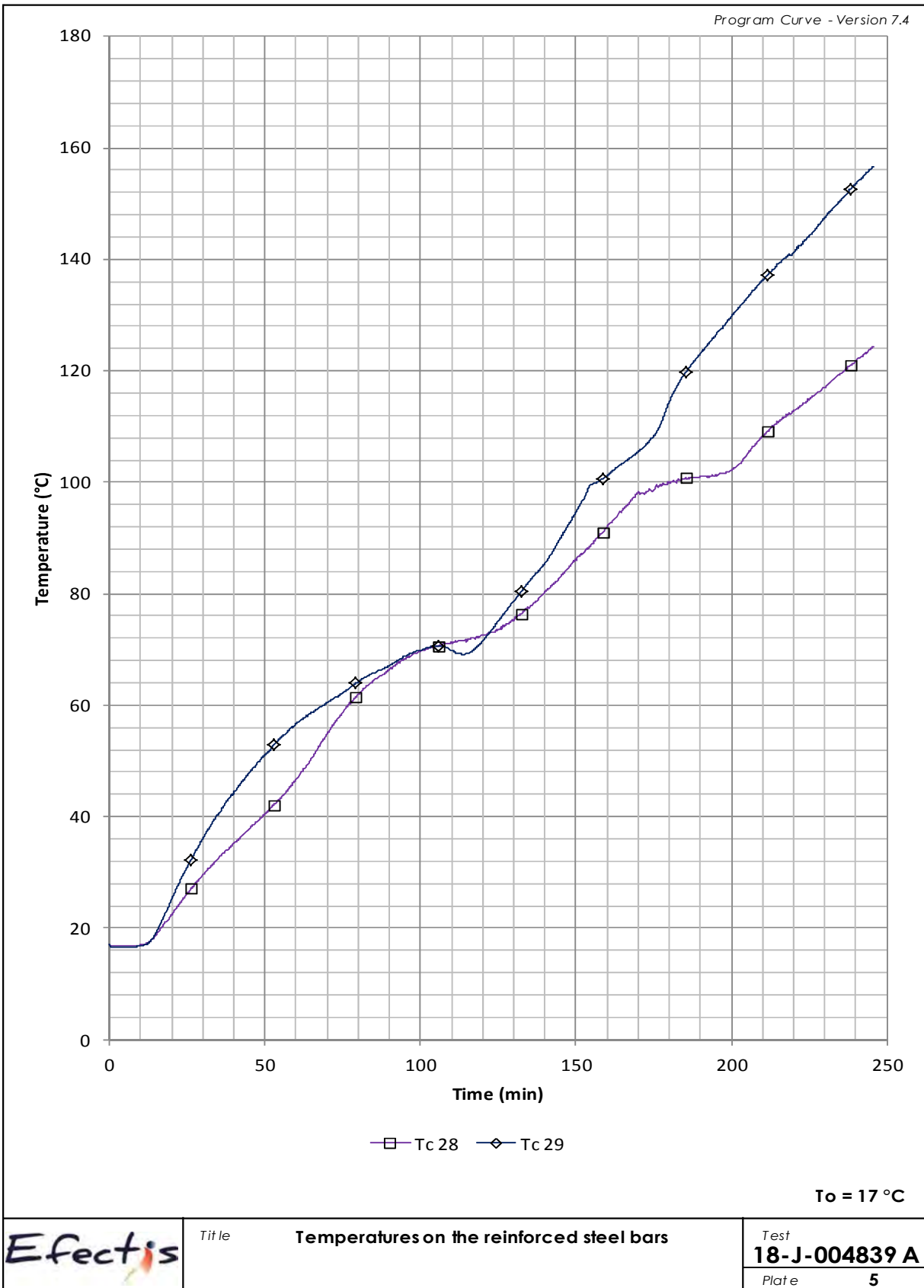



APPENDIX n° 4: PHOTOGRAPHS



<b>Photo A</b> (top)	Installation of the protective board on the concrete slab.
<b>Photo B</b> (bottom)	Exposed side before the start of the test.

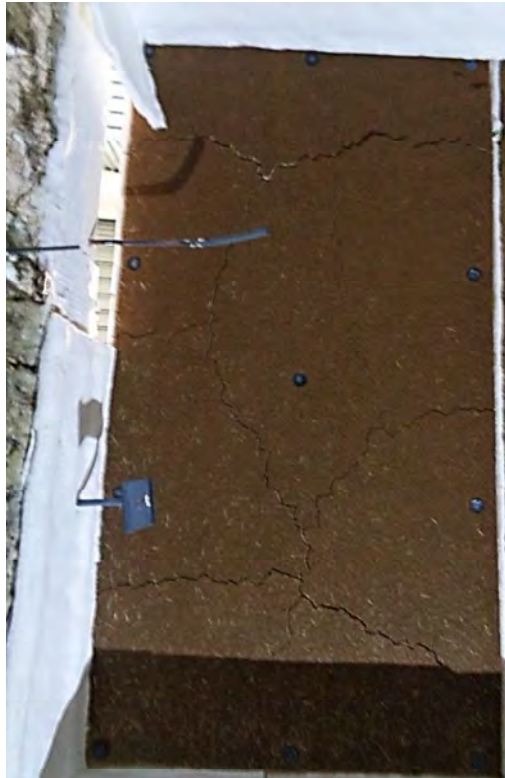

<b>Photo C (top)</b>	Exposed side after the test and cooling down.
<b>Photo D (bottom)</b>	Exposed side after the test and cooling down.

**END OF THE REPORT**

## **FIRE TEST REPORT EFR-18-J-004839 B**

Inspired by EN 1363-1 : 2012, EN 13381-3 : 2015 standards and the French guide issued by CETU (Centre d'Etudes des Tunnels): "Passive fire protection systems", march 2017

<b>Test</b>	EFR-18-J-004839
<b>Performed on</b>	April 17 <sup>th</sup> , 2019
<b>Regarding</b>	<p>Research test on a passive protection applied on a concrete slab of overall dimensions 2200 x 1000 x 400 mm (L x W x Th). Six small boards and back strips were installed on exposed side of concrete slab with 38 mechanical anchors.</p> <ul style="list-style-type: none"><li>▪ Trade reference of the boards: AESTUVER TX</li><li>▪ Trade reference of the back strips: AESTUVER T</li><li>▪ Thickness of the protection: 40 mm (boards) + 10 mm (back strips)</li><li>▪ Trade reference of the anchors: HFB-R 6x85</li></ul>
<b>Sponsor</b>	HILTI CORPORATION FeldkircherStrasse 100 9494 SCHAAN LIECHTENSTEIN

## 1. SCOPE OF THIS TEST REPORT

---

Fire resistance test of a concrete slab protected by a protective system according to a method inspired by the standard EN 1363-1: 2012, EN 13381-3: 2015 and the French guide issued by CETU (Centre d'Etudes des Tunnels): "Passive fire protection systems", march 2017.

## 2. TEST LABORATORY

---

EFFECTIS FRANCE  
149, route du Marc  
F - 38630 LES AVENIÈRES VEYRINS-THUELLIN

## 3. REFERENCE AND MANUFACTURER OF THE TESTED SPECIMEN

---

### Protective system:

Reference: AESTUVER TX + AESTUVER T  
Manufacturer: FERMACELL GmbH  
39240 CALBE  
GERMANY

### Anchors:

Reference: HFB-R 6x85  
Manufacturer: HILTI CORPORATION  
FeldkircherStrasse 100  
9494 SCHAAN  
LIECHTENSTEIN

## 4. FURTHER INFORMATION FOR CE MARKING

---

*(Chapter not covered under the COFRAC's accreditation).*  
The tested element has not been collected.

## 5. DESCRIPTION OF THE TESTED SPECIMEN

---

**The information below were provided by the applicant who attests their accuracy.**

### 5.1. GENERAL

The tested specimen was a concrete slab protected on its exposed side by six small protective boards AESTUVER TX (FERMACELL) of thickness 40 mm and back strips AESTUVER T (FERMACELL) of thickness 10 mm.

The boards were fixed on the slab with mechanical anchors type concrete screw HFB-R Ø 6 x 85 mm (HILTI). Some anchors were loaded with weights.

The dimensions were:

- Overall dimensions of the slab : 2200 x 1000 x 400 mm (L x W x Th)
- Protected area : 1900 x 1000 mm (L x W)
- Exposed area : 1900 x 1000 mm (L x W).

**5.2. LIST OF THE COMPONENTS**

According to the information supplied by the Sponsor.

<b>Name</b>	<b>Trade reference</b>	<b>Material</b>	<b>Characteristics</b>	<b>Supplier</b>
Board	AESTUVER TX	Cement bonded system	Th = 40 mm d = 680-800 kg/m <sup>3</sup>	FERMACELL
Back strip	AESTUVER T		Th = 10 mm d = 690-980 kg/m <sup>3</sup>	
Anchor	HFB-R	Stainless steel	Ø 6 x 85 mm	HILTI
Washer *	-	Stainless steel	Ø 6.5 x 30 mm	

Th = thickness --- d = density --- Ø = diameter

\* Washer was delivered with the anchor.

**5.3. DETAILED DESCRIPTION OF THE SPECIMEN**

5.3.1. Concrete slab

<b>Characteristics</b>	<b>Datas</b>
Overall dimensions	2200 x 1000 x 400 mm (L x W x Th)
Concrete strength class	C 25 / 30
Aggregates	Silicious
Reinforcing bars	According to EN 13381-3: 2015
Date of casting	28 <sup>th</sup> February 2019
Density measured	2245 kg/m <sup>3</sup>

5.3.2. Protective board

The drawings in the appendices n° 1 and n° 2 have been supplied by the Sponsor.

Six small boards AESTUVER TX (FERMACELL) were installed on exposed side of concrete slab (see photo A). No surface preparation of the concrete slab was undertaken prior to installation of boards. The dimensions of the boards were 665 x 500 mm (L x W) or 565 x 500 mm (L x W) and thickness 40 mm. The exact dimensions of the boards are reported in the appendix n° 1.

Under the edges of the boards were installed back strips AESTUVER T (FERMACELL) of thickness 10 mm. The back strips and boards were joined together by glue with reference SIKABOND 113 RAPID CURE GRAY (SIKA). The location of the back strips are reported in the appendix n° 1 with dotted line.

The boards were fixed on the slab with 6 or 7 mechanical anchors type concrete screw HFB-R Ø 6 x 85 mm (HILTI). The location of anchors are reported in the appendix n° 1. The anchors were previously equipped with washers made of stainless steel dimensions Ø 6.5 x 30 mm and thickness 1.5 mm.

For each board, the anchors located on the edges were fixed through the back strip and the anchor in the middle was fixed with weights. The weights were steel discs of thickness 8 mm with an aperture of Ø 7.5 mm in the center. The outer diameter and the value of weights are reported in the appendix n° 2.

#### 5.4. VERIFICATION

The laboratory performed a detailed examination of the test item prior to testing and verified the accuracy of the information provided.

### 6. TEST ASSEMBLY

---

#### 6.1. DEFINITION OF THE TESTED SPECIMEN

The choice and the definition of this test specimen have been carried out by the Sponsor.

#### 6.2. ASSEMBLY OF THE TESTED SPECIMEN

##### 6.2.1. Test mounting

The concrete slab was installed on the furnace structure and was exposed on 1900 x 1000 mm (L x W) area.

##### 6.2.2. Staff

The concrete slab had been casted by the staff of the test laboratory.

The installation of the protective system on the concrete slab had been made by the skillful staff of the Sponsor.

### 7. TEST METHOD

---

#### 7.1. PRELIMINARY CONDITIONING

The weight stability of the concrete slab was reached on the day of the test.

#### 7.2. THERMAL PROGRAM

The temperature rise inside the furnace above the ambient temperature was controlled according to the **RWS thermal program** according to the Sponsor's request, represented by the following table:

<i>Time (minutes)</i>	<i>Temperature (°C)</i>
0	20
3	890
5	1140
10	1200
30	1300
60	1350
90	1300



Then, after 90 minutes of RWS thermal program, the temperature inside the furnace above the ambient temperature was controlled according to the **Majorated Hydrocarbon Curve (HCM)**, represented by the following function:

$$T = 1280 (1 - 0,325 e^{-0.167 t} - 0,675 e^{-2.5 t}) + 20$$

Then, after 132 minutes (120 minutes + 10%) of RWS + HCM program, the temperature inside the furnace above the ambient temperature was controlled until the end of the test according to the **standard thermal program**, represented by the following function:

$$T = 345 \log_{10} (8t+1) + 20$$

where:

$t$  = Time (min)

$T$  = Furnace temperature at time  $t$  (°C).

### 7.3. AMBIENT PRESSURE

According to paragraph A.10 of the guide, no pressure order was followed because the pressure is considered as an uninfluential factor on the test results.

## 8. MEASUREMENTS DURING THE FIRE TEST AND TEST RESULTS

The location of the thermocouples are shown in appendix n° 3.

The measurement results are reported in appendix n° 4, on the plates mentioned hereafter.

### 8.1. TEMPERATURE MEASUREMENTS

#### 8.1.1. Ambient temperature in the laboratory

The ambient temperature was measured according to the requirements of the standard EN 1363-1: 2012, by a Type K thermocouple.

Location	Marking	Appendix
Ambient temperature in the laboratory	Tc 11	1

#### 8.1.2. Ambient temperature in the furnace

It was measured in conformity with the standard EN 1363-1: 2012 by 10 plate pyrometers with their metal face towards the bottom of the furnace. 4 Type S thermocouples were added for security reason.

Location	Markings	Appendix
Ambient temperature in the furnace, at 100 mm under the exposed face	Tc 1 to 10 Tc 40 to 43	2

8.1.3. Temperatures of the specimen

The temperatures were measured by Type K thermocouples according to the requirements of the Sponsor.

Location	Markings	Appendix
Temperatures at the interface between the concrete slab and the protection	Tc 14 to 19	4
Temperatures on the reinforced steel bars	Tc 30 to 31	5

8.2. PRESSURE MEASUREMENTS

In conformity with the requirements of the standard EN 1363-1: 2012, the pressure inside the furnace was continuously controlled throughout the whole test.

Location	Marking	Appendix
Ambient pressure inside the furnace, at 100 mm under the exposed face	Pr 50	3

9. OBSERVATIONS

---

9.1. BEFORE THE TEST

- Ambient temperature inside the laboratory : 15°C
- Specimen temperature before the test : 17°C.

9.2. DURING THE TEST

Time (min)	Observations
0	<b>Start of the fire test</b> (see photo B).
80	Appearance of cracks in the boards.
90	Switching of heating program, from RWS to HCM.
132	Switching of heating program, from HCM to standard thermal program.
<b>245</b>	<b>End of the test on request of the Sponsor.</b>

9.3. AFTER THE TEST AND COOL DOWN

The protective system was still in place, it was cracked in several point (see photo C).



## 10. WARNING

---

'This report gives details about the construction method, the testing conditions and the test results achieved when the specific building element described was tested according to the procedure specified in standard EN 1363-1: 2012 and, where applicable, in standard EN 1363-2: 1999.

As concerns the dimensions, details, loading, stresses and boundary or end conditions, any significant deviation other than that which is not excluded within the field of direct application of the appropriate test procedure is not covered by this report.

Because of the nature of the fire tests and of the resulting difficulty in quantifying the uncertainty of the fire resistance assessment, it is impossible to establish any level of accuracy of the results.'

Les Avenières Veyrins-Thuellin, the 5<sup>th</sup> August 2019

  
X

---

Project Leader  
Signé par : Amélie BRUNON

  
X

---

Test Supervisor  
Signé par : Clifford CHINAYA

APPENDIX n° 1: LOCATION OF THE ANCHORS

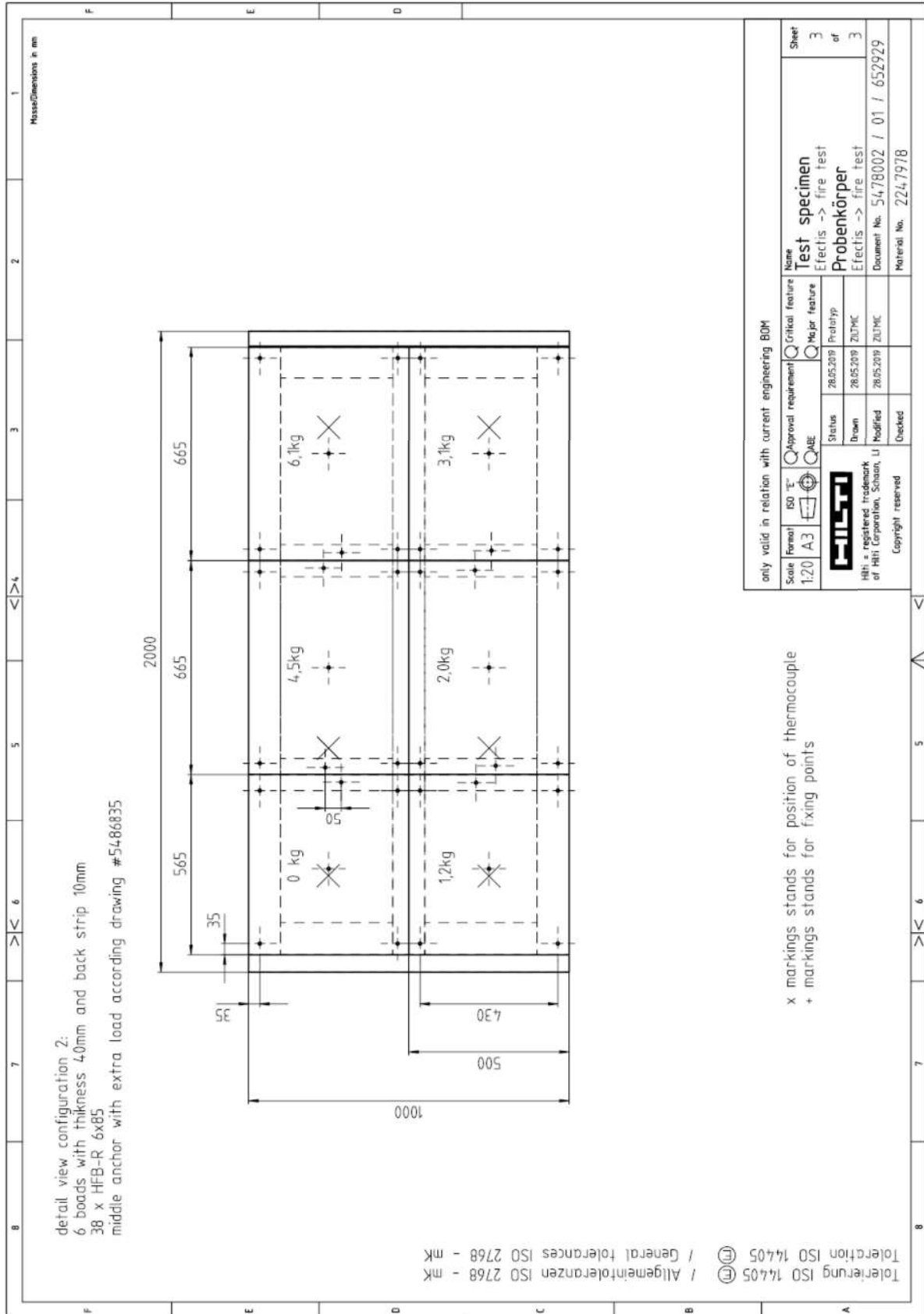

APPENDIX n° 2: DRAWING OF THE WEIGHTS

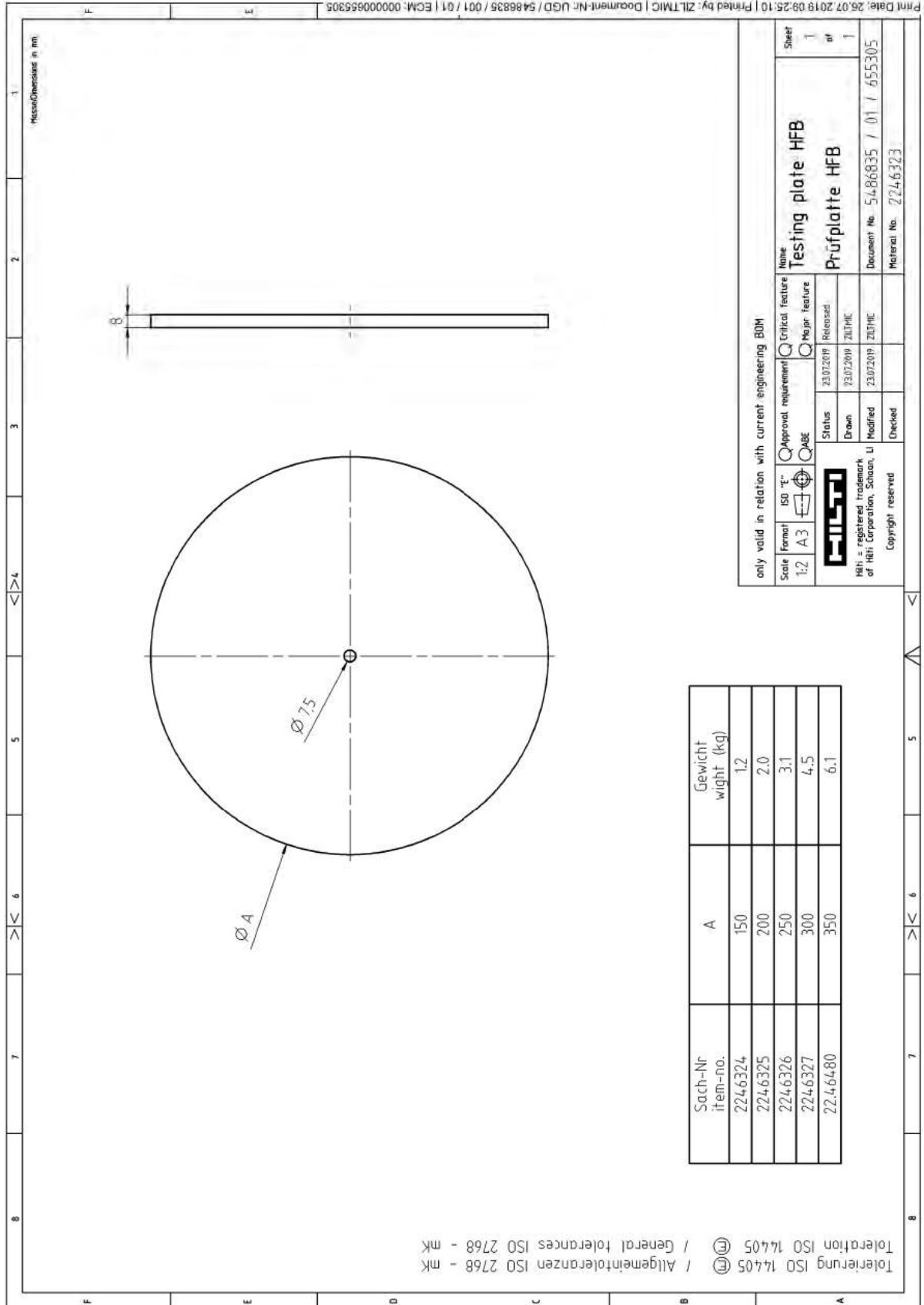

APPENDIX n° 3: LOCATION OF THE THERMOCOUPLES

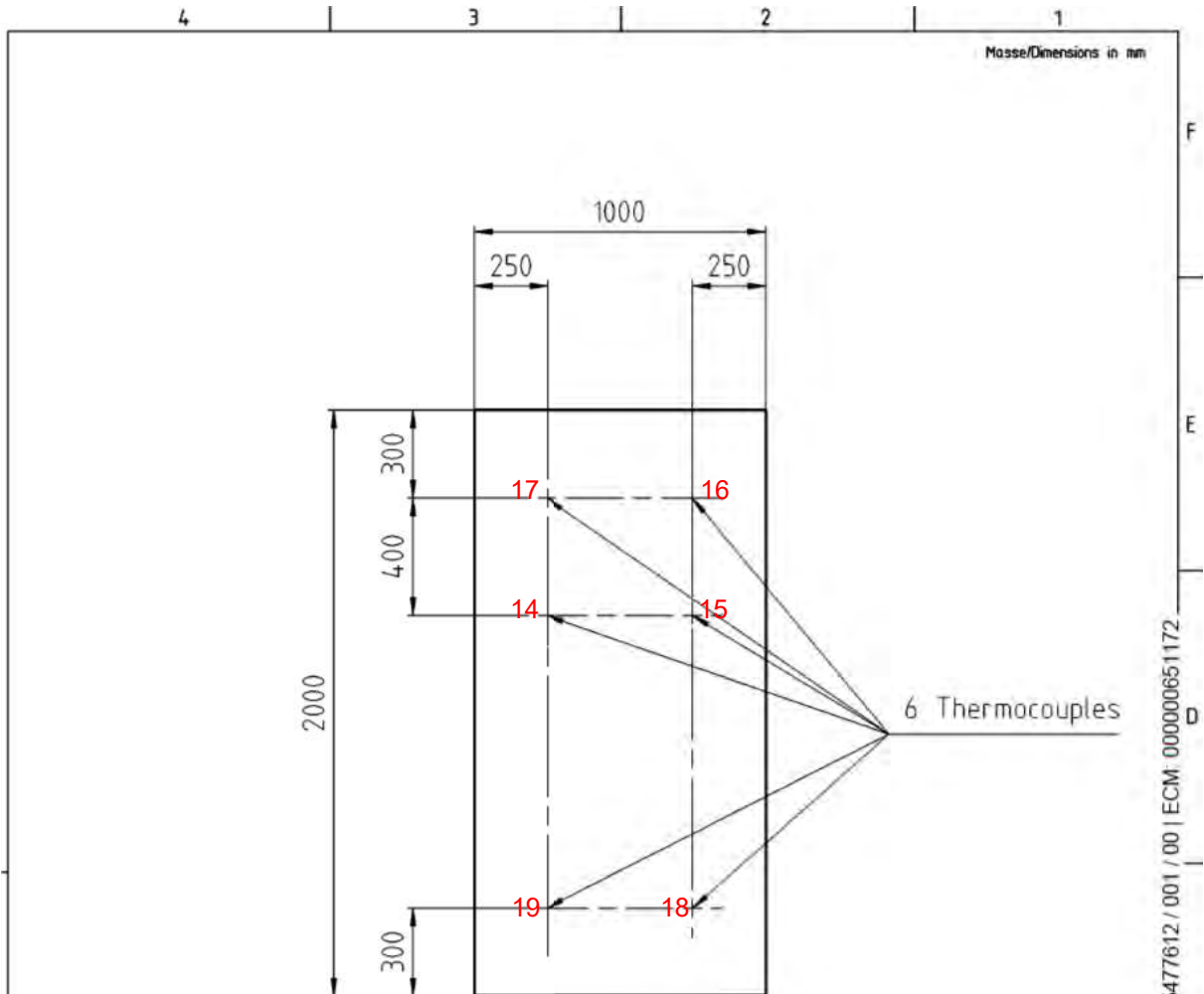

Tc	Weight (kg)
16	0
17	1.2
14	2.0
19	3.1
15	4.5
18	6.1

only valid in relation with current engineering BOM							
Scale 1:20	Format A4	ISO "E" 	<input type="checkbox"/> Approval requirement <input type="checkbox"/> ABE	<input type="checkbox"/> Critical feature <input type="checkbox"/> Major feature	Name <b>Concrete block</b> Efectis - 6 thermocoup <b>Betonblock</b> Efectis - 6 thermocoup	Sheet 1 of 1	
 Hilti = registered trademark of Hilti Corporation, Schaan, LI Copyright reserved		Status	15.04.2019	Released	Document No. 5477612 / 00 / 651172		
		Drawn	14.02.2019	ZILTMIC			
		Modified	15.04.2019	ZILTMIC			Material No. 2241296
		Checked					

Print Date: 15.04.2019 17:27:33 | Printed by: ZILTMIC | Document-Nr: UGD / 5477612 / 001 / 00 | ECM: 000000651172

APPENDIX n° 4: CHARTS

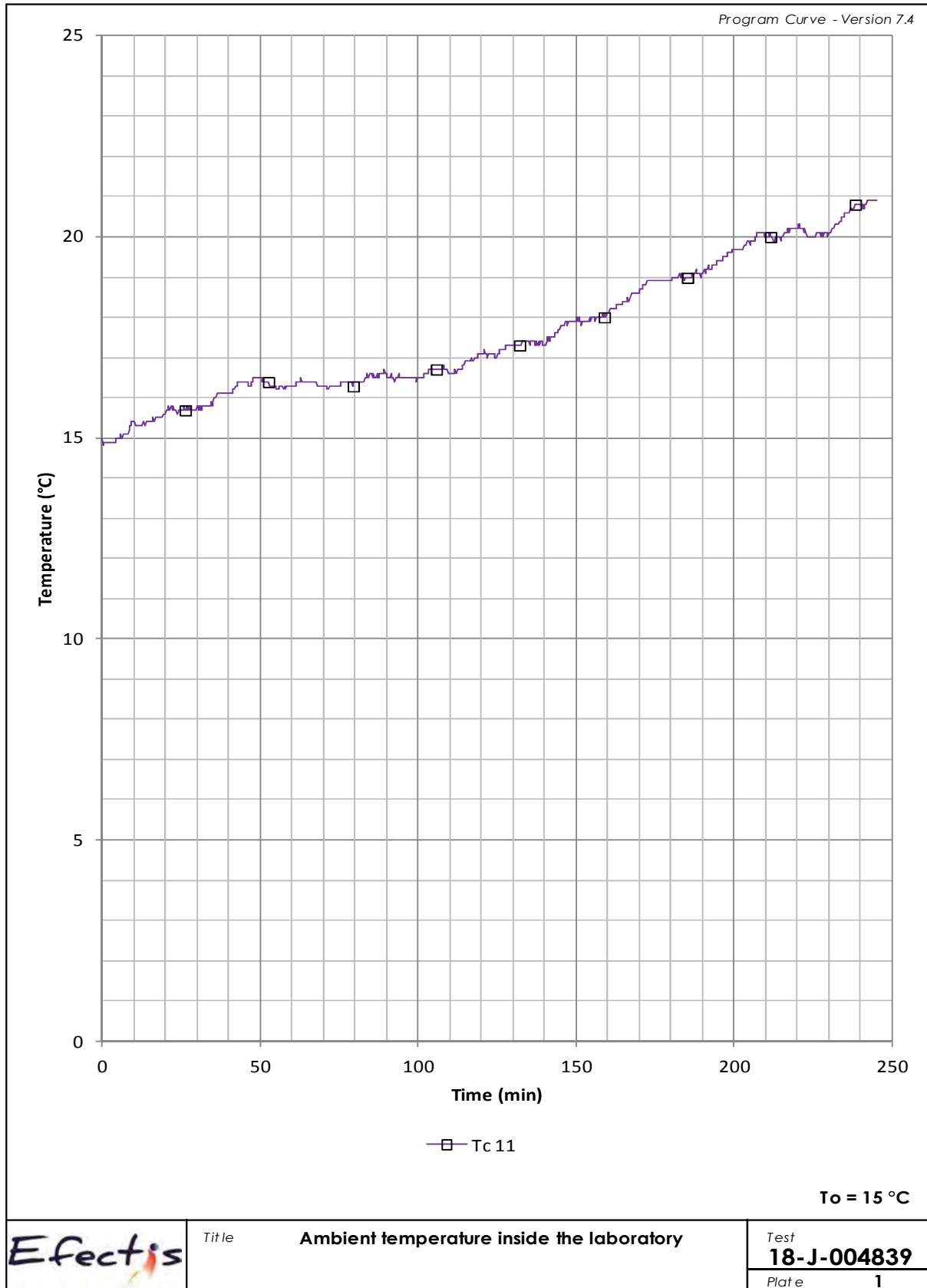

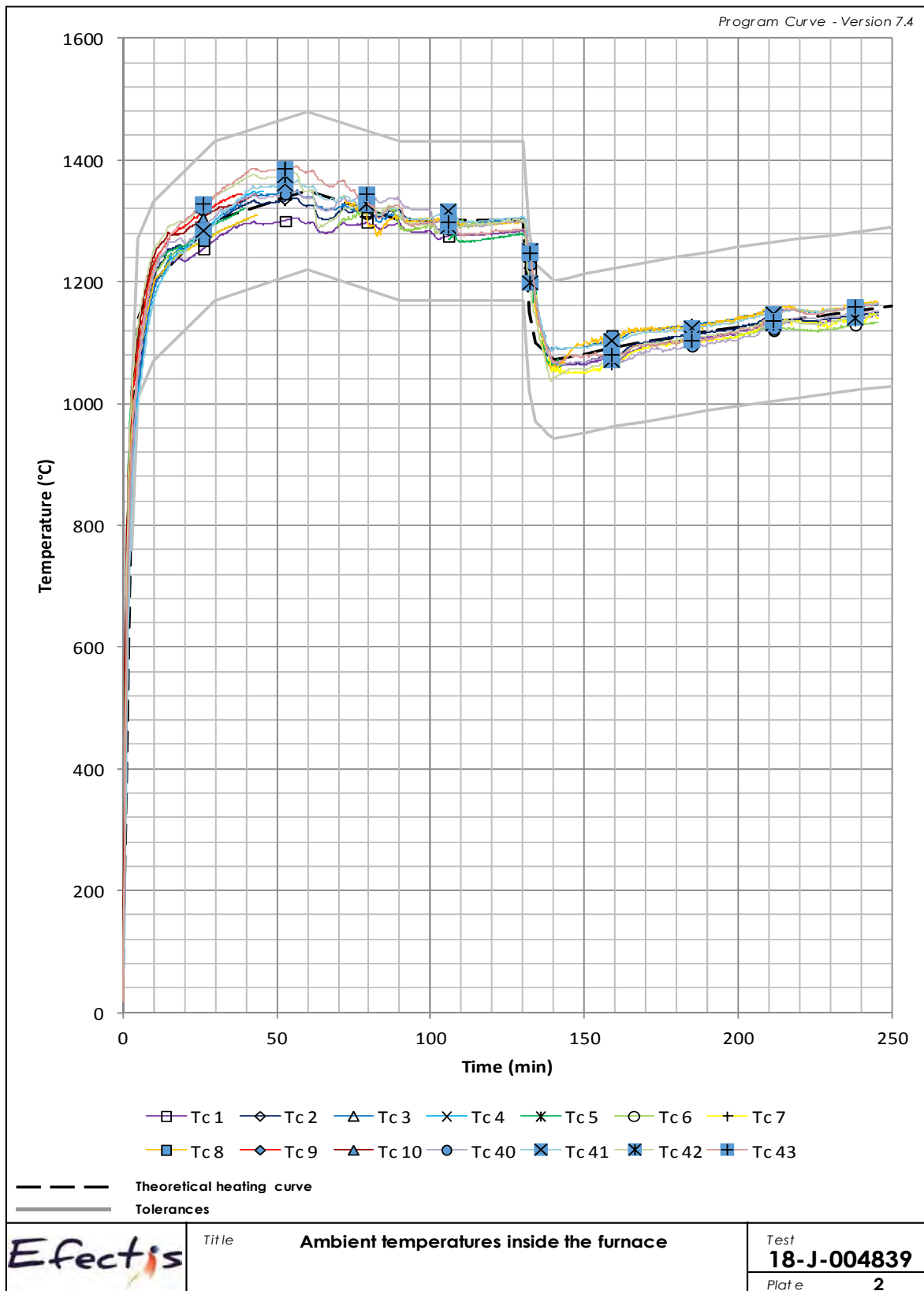

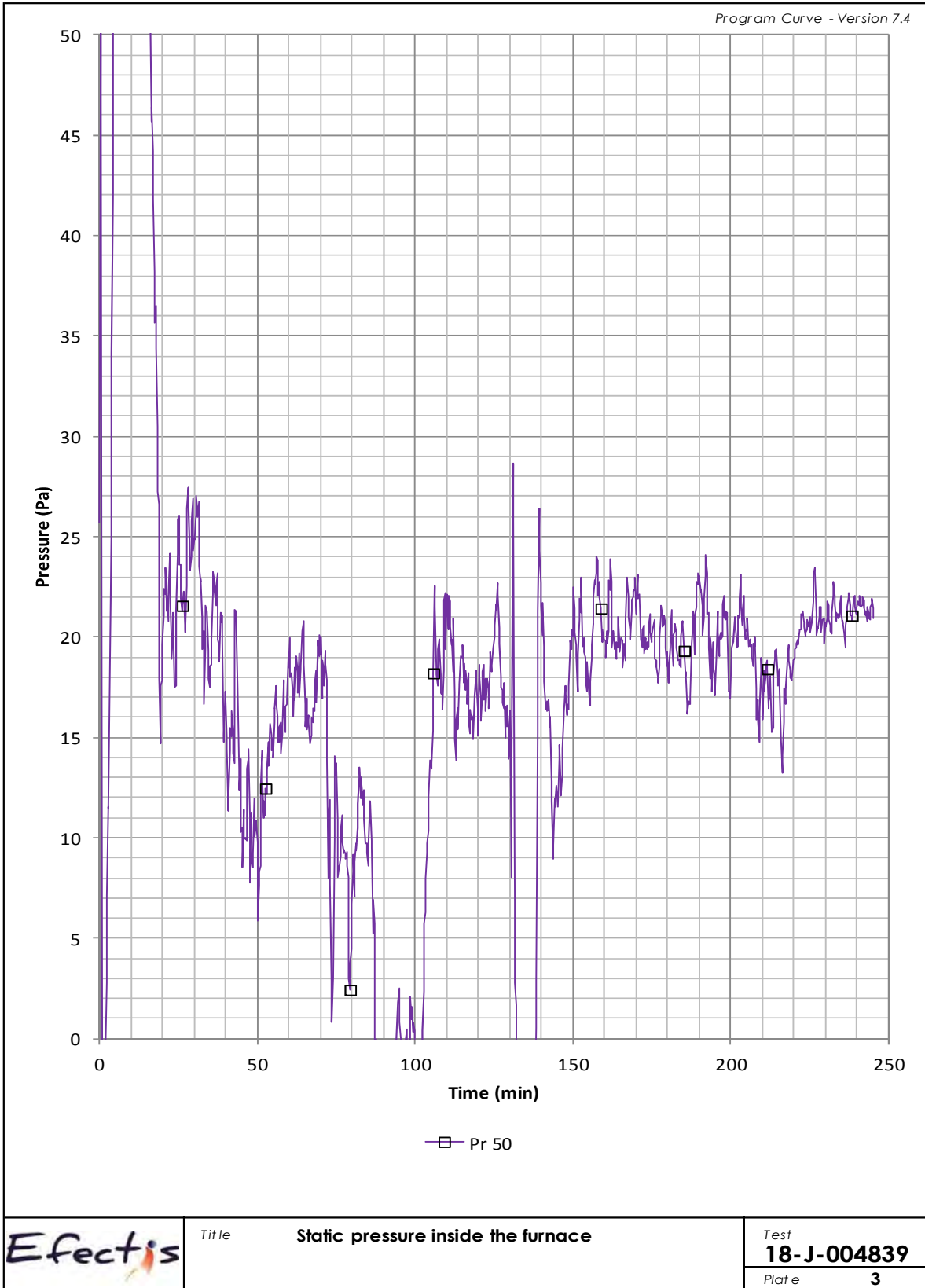

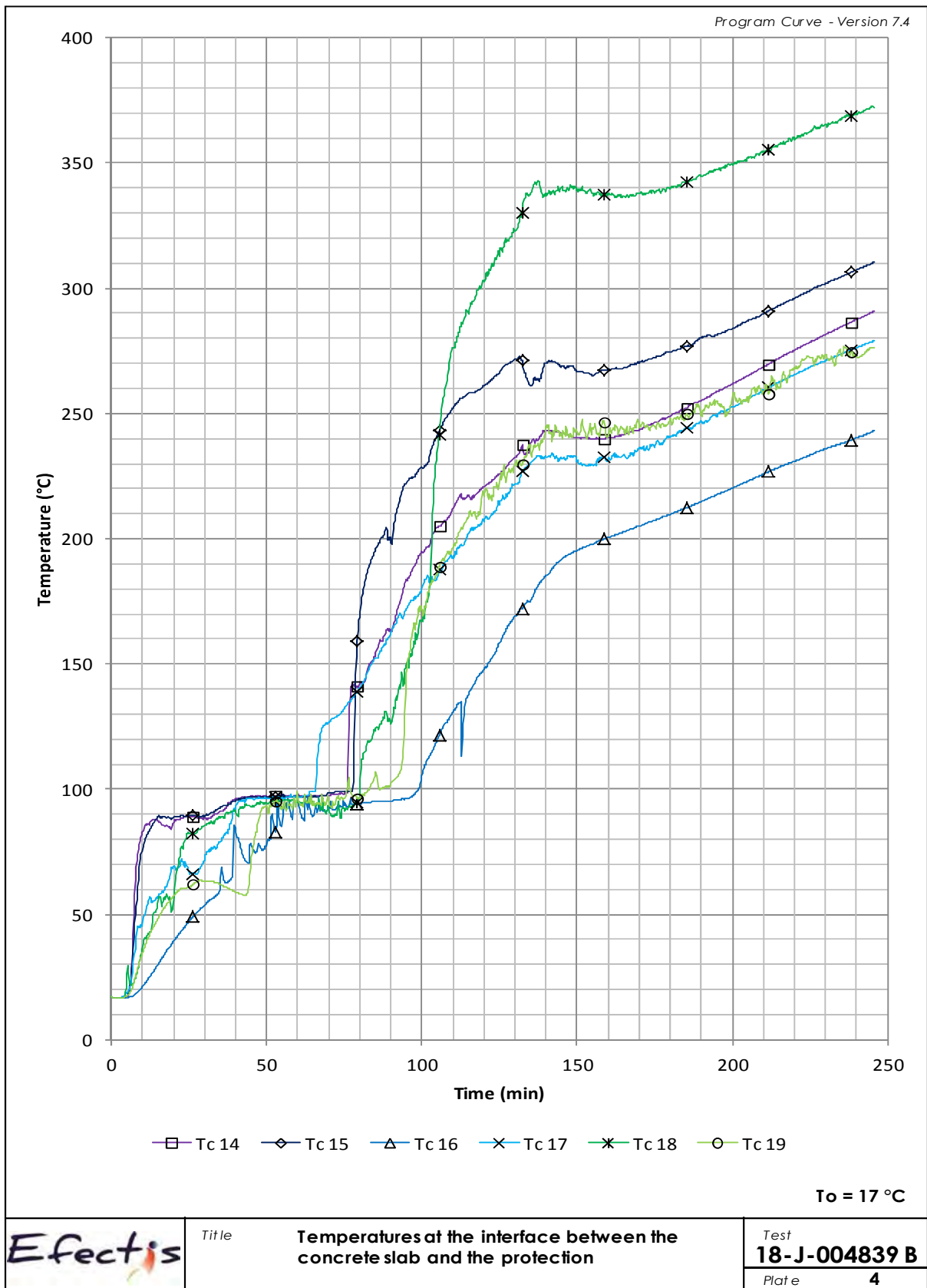



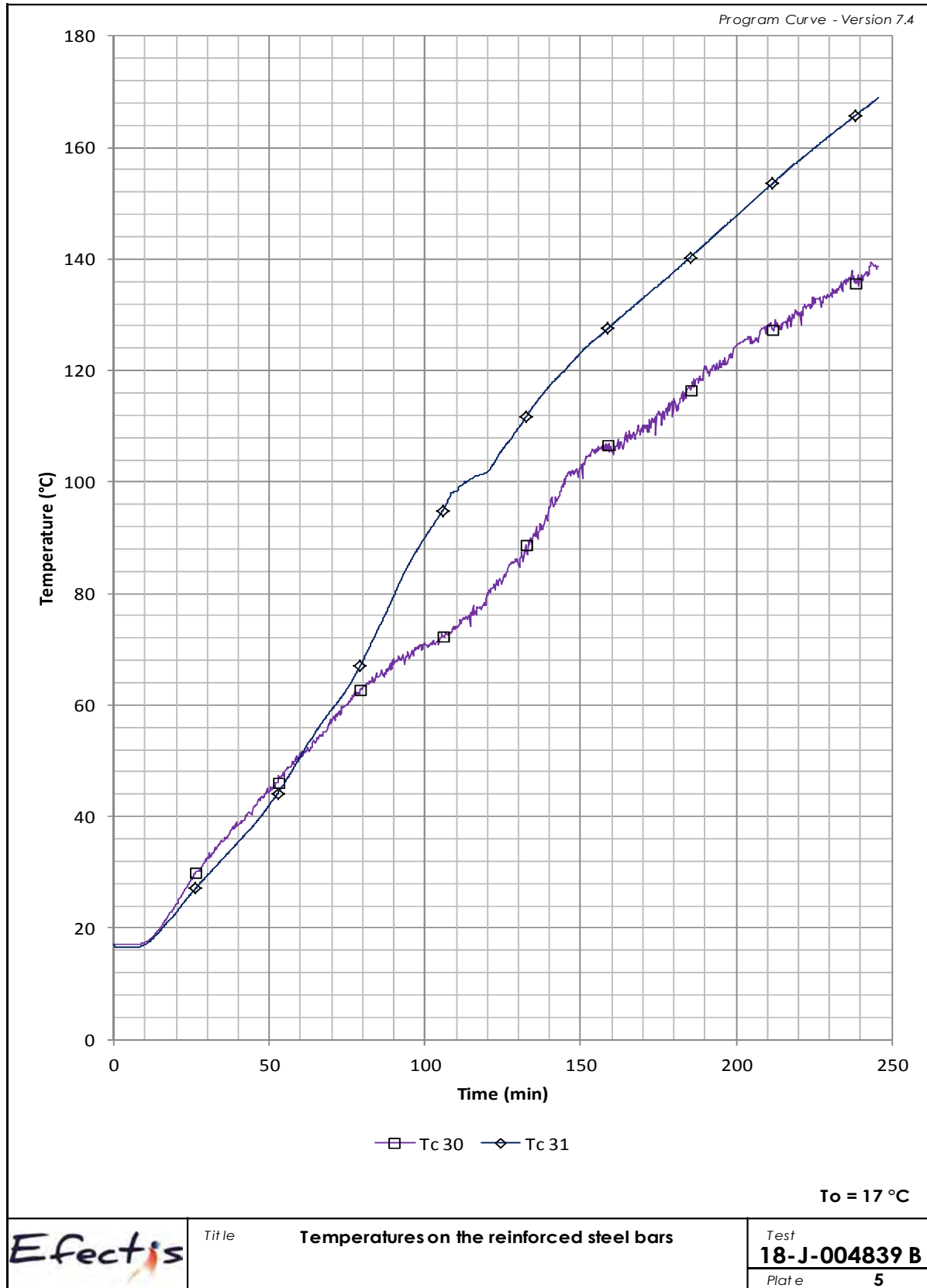

APPENDIX n° 5: PHOTOGRAPHS



<b>Photo A (top)</b>	Installation of the protective boards on the concrete slab.
<b>Photo B (bottom)</b>	Exposed side before the start of the test.

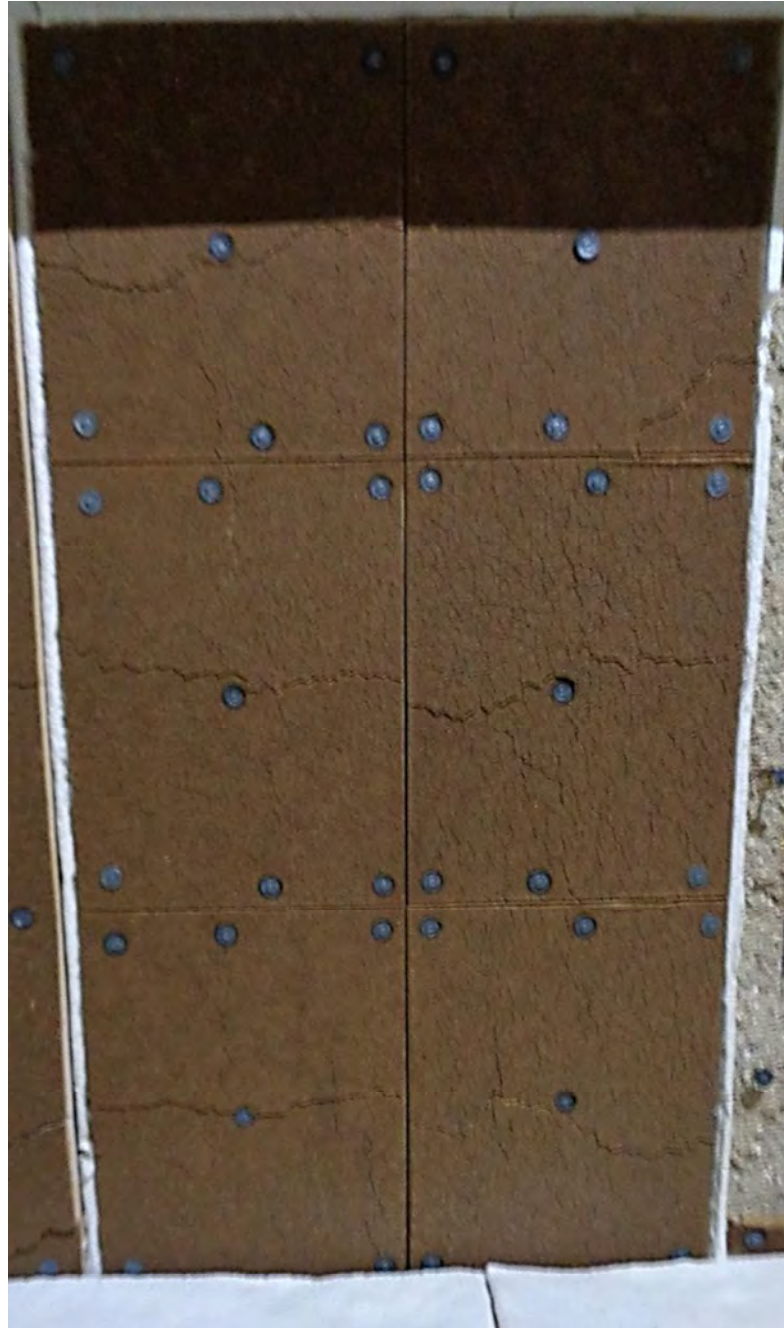

<b>Photo C</b>	Exposed side after the test and cooling down.
----------------	---

**END OF THE REPORT**

## **FIRE TEST REPORT EFR-18-J-004839 D**

Inspired by EN 1363-1: 2012, EN 13381-3: 2015 standards and the French guide issued by CETU (Centre d'Études des Tunnels): "Passive fire protection systems", march 2017

<b>Test</b>	EFR-18-J-004839
<b>Performed on</b>	April 17 <sup>th</sup> , 2019
<b>Regarding</b>	<p>Research test on a passive protection applied on a concrete slab of overall dimensions 2200 x 1000 x 400 mm (L x W x Th). Two boards were installed on exposed side of concrete slab with 15 mechanical anchors.</p> <ul style="list-style-type: none"><li>▪ Trade reference of the board: AESTUVER TX</li><li>▪ Thickness of the board: 50 mm</li><li>▪ Trade reference of the anchors: HFB-R 6x85</li></ul>
<b>Sponsor</b>	<p>HILTI CORPORATION FeldkircherStrasse 100 9494 SCHAAN LIECHTENSTEIN</p>

## 1. SCOPE OF THIS TEST REPORT

---

Fire resistance test of a concrete slab protected by a protective system according to a method inspired by the standard EN 1363-1: 2012, EN 13381-3: 2015 and the French guide issued by CETU (Centre d'Etudes des Tunnels): "Passive fire protection systems", march 2017.

## 2. TEST LABORATORY

---

EFFECTIS FRANCE  
149, route du Marc  
F - 38630 LES AVENIÈRES VEYRINS-THUELLIN

## 3. REFERENCE AND MANUFACTURER OF THE TESTED SPECIMEN

---

### Protective system:

Reference: AESTUVER TX  
Manufacturer: FERMACELL GmbH  
39240 CALBE  
GERMANY

### Anchors:

Reference: HFB-R 6x85  
Manufacturer: HILTI CORPORATION  
FeldkircherStrasse 100  
9494 SCHAAN  
LIECHTENSTEIN

## 4. FURTHER INFORMATION FOR CE MARKING

---

*(Chapter not covered under the COFRAC's accreditation).*

The tested element has not been collected

## 5. DESCRIPTION OF THE TESTED SPECIMEN

---

**The information below were provided by the applicant who attests their accuracy.**

### 5.1. GENERAL

The tested specimen was a concrete slab protected on its exposed side by two protective boards AESTUVER TX (FERMACELL) of thickness 50 mm.

The boards were fixed directly on the slab with mechanical anchors type concrete screw HFB-R Ø 6 x 85 mm (HILTI).

The dimensions were:

- Overall dimensions of the slab : 2200 x 1000 x 400 mm (L x W x Th)
- Protected area : 1900 x 1000 mm (L x W)
- Exposed area : 1900 x 1000 mm (L x W).

## 5.2. LIST OF THE COMPONENTS

According to the information supplied by the Sponsor.

Name	Trade reference	Material	Characteristics	Supplier
Board	AESTUVER TX	Cement bonded system	Th = 50 mm d = 680-800 kg/m <sup>3</sup>	FERMACELL
Anchor	HFB-R	Stainless steel	Ø 6 x 85 mm	HILTI
Washer *	-	Stainless steel	Ø 6.5 x 30 mm	

Th = thickness --- d = density --- Ø = diameter

\* Washer was delivered with the anchor.

## 5.3. DETAILED DESCRIPTION OF THE SPECIMEN

### 5.3.1. Concrete slab

Characteristics	Datas
Overall dimensions	2200 x 1000 x 400 mm (L x W x Th)
Concrete strength class	C 25 / 30
Aggregates	Silicious
Reinforcing bars	According to EN 13381-3: 2015
Date of casting	21 <sup>th</sup> February 2019
Density measured	2223 kg/m <sup>3</sup>

### 5.3.2. Protective board

The drawing in the appendix n° 1 have been supplied by the Sponsor.

Two boards AESTUVER TX (FERMACELL) were installed on exposed side of concrete slab (see photo A). No surface preparation of the concrete slab was undertaken prior to installation of boards. The dimensions of the boards were 700 x 1000 mm (L x W) and 1200 x 1000 mm (L x W) and thickness 50 mm.

The boards were fixed on the slab with mechanical anchors type concrete screw HFB-R Ø 6 x 85 mm (HILTI). The location of anchors are reported in the appendix n° 1.

- Small board : 6 mechanical anchors
- Large board : 9 mechanical anchors.

The mechanical anchors for the small board were removed and replaced with 6 other mechanical anchors (HFB-R Ø 6 x 85 mm).

The anchors were previously equipped with washers made of stainless steel dimensions Ø 6.5 x 30 mm and thickness 1.5 mm.

## 5.4. VERIFICATION

The laboratory performed a detailed examination of the test item prior to testing and verified the accuracy of the information provided.

## 6. TEST ASSEMBLY

---

### 6.1. DEFINITION OF THE TESTED SPECIMEN

The choice and the definition of this test specimen have been carried out by the Sponsor.

### 6.2. ASSEMBLY OF THE TESTED SPECIMEN

#### 6.2.1. Test mounting

The concrete slab was installed on the furnace structure and was exposed on 1900 x 1000 mm (L x W) area.

#### 6.2.2. Staff

The concrete slab had been casted by the staff of the test laboratory.

The installation of the protective system on the concrete slab had been made by the skillful staff of the Sponsor.

## 7. TEST METHOD

---

### 7.1. PRELIMINARY CONDITIONING

The weight stability of the concrete slab was reached on the day of the test.

### 7.2. THERMAL PROGRAM

The temperature rise inside the furnace above the ambient temperature was controlled according to the **RWS thermal program** according to the Sponsor's request, represented by the following table:

<i>Time (minutes)</i>	<i>Temperature (°C)</i>
0	20
3	890
5	1140
10	1200
30	1300
60	1350
90	1300

Then, after 90 minutes of RWS thermal program, the temperature inside the furnace above the ambient temperature was controlled according to the **Majorated Hydrocarbon Curve (HCM)**, represented by the following function:

$$T = 1280 (1 - 0,325 e^{-0.167 t} - 0,675 e^{-2.5 t}) + 20$$

Then, after 132 minutes (120 minutes + 10%) of RWS + HCM program, the temperature inside the furnace above the ambient temperature was controlled until the end of the test according to the **standard thermal program**, represented by the following function:

$$T = 345 \log_{10} (8t+1) + 20$$

where:

$t$  = Time (min)

$T$  = Furnace temperature at time  $t$  (°C).



**7.3. AMBIENT PRESSURE**

According to paragraph A.10 of the guide, no pressure order was followed because the pressure is considered as an uninfluential factor on the test results.

**8. MEASUREMENTS DURING THE FIRE TEST AND TEST RESULTS**

---

The location of the thermocouples are shown in appendix n° 2.

The measurement results are reported in appendix n° 3, on the plates mentioned hereafter.

**8.1. TEMPERATURE MEASUREMENTS**

8.1.1. Ambient temperature in the laboratory

The ambient temperature was measured according to the requirements of the standard EN 1363-1: 2012, by a Type K thermocouple.

<i>Location</i>	<i>Marking</i>	<i>Appendix</i>
Ambient temperature in the laboratory	Tc 11	1

8.1.2. Ambient temperature in the furnace

It was measured in conformity with the standard EN 1363-1: 2012 by 10 plate pyrometers with their metal face towards the bottom of the furnace. 4 Type S thermocouples were added for security reason.

<i>Location</i>	<i>Markings</i>	<i>Appendix</i>
Ambient temperature in the furnace, at 100 mm under the exposed face	Tc 1 to 10 Tc 40 to 43	2

8.1.3. Temperatures of the specimen

The temperatures were measured by Type K thermocouples according to the requirements of the Sponsor.

<i>Location</i>	<i>Markings</i>	<i>Appendix</i>
Temperatures at the interface between the concrete slab and the protection	Tc 22 to 23	4
Temperatures on the reinforced steel bars	Tc 34 to 35	5

**8.2. PRESSURE MEASUREMENTS**

In conformity with the requirements of the standard EN 1363-1: 2012, the pressure inside the furnace was continuously controlled throughout the whole test.

<i>Location</i>	<i>Marking</i>	<i>Appendix</i>
Ambient pressure inside the furnace, at 100 mm under the exposed face	Pr 50	3



**9. OBSERVATIONS**

**9.1. BEFORE THE TEST**

- Ambient temperature inside the laboratory : 15°C
- Specimen temperature before the test : 17°C.

**9.2. DURING THE TEST**

Time (min)	Observations
0	<b>Start of the fire test</b> (see photo B).
90	Switching of heating program, from RWS to HCM.
132	Switching of heating program, from HCM to standard thermal program.
<b>245</b>	<b>End of the test on request of the Sponsor.</b>

**9.3. AFTER THE TEST AND COOL DOWN**

The protective system was still in place, it was cracked in several point (see photo C and D).

**10. WARNING**

'This report gives details about the construction method, the testing conditions and the test results achieved when the specific building element described was tested according to the procedure specified in standard EN 1363-1: 2012 and, where applicable, in standard EN 1363-2: 1999.

As concerns the dimensions, details, loading, stresses and boundary or end conditions, any significant deviation other than that which is not excluded within the field of direct application of the appropriate test procedure is not covered by this report.

Because of the nature of the fire tests and of the resulting difficulty in quantifying the uncertainty of the fire resistance assessment, it is impossible to establish any level of accuracy of the results.'

Les Avenières Veyrins-Thuellin, the 5<sup>th</sup> August 2019

X *Amélie BRUNON*

Project Leader  
Signé par : Amélie BRUNON

X *Clifford CHINAYA*

Test Supervisor  
Signé par : Clifford CHINAYA

APPENDIX n° 1: LOCATION OF THE ANCHORS

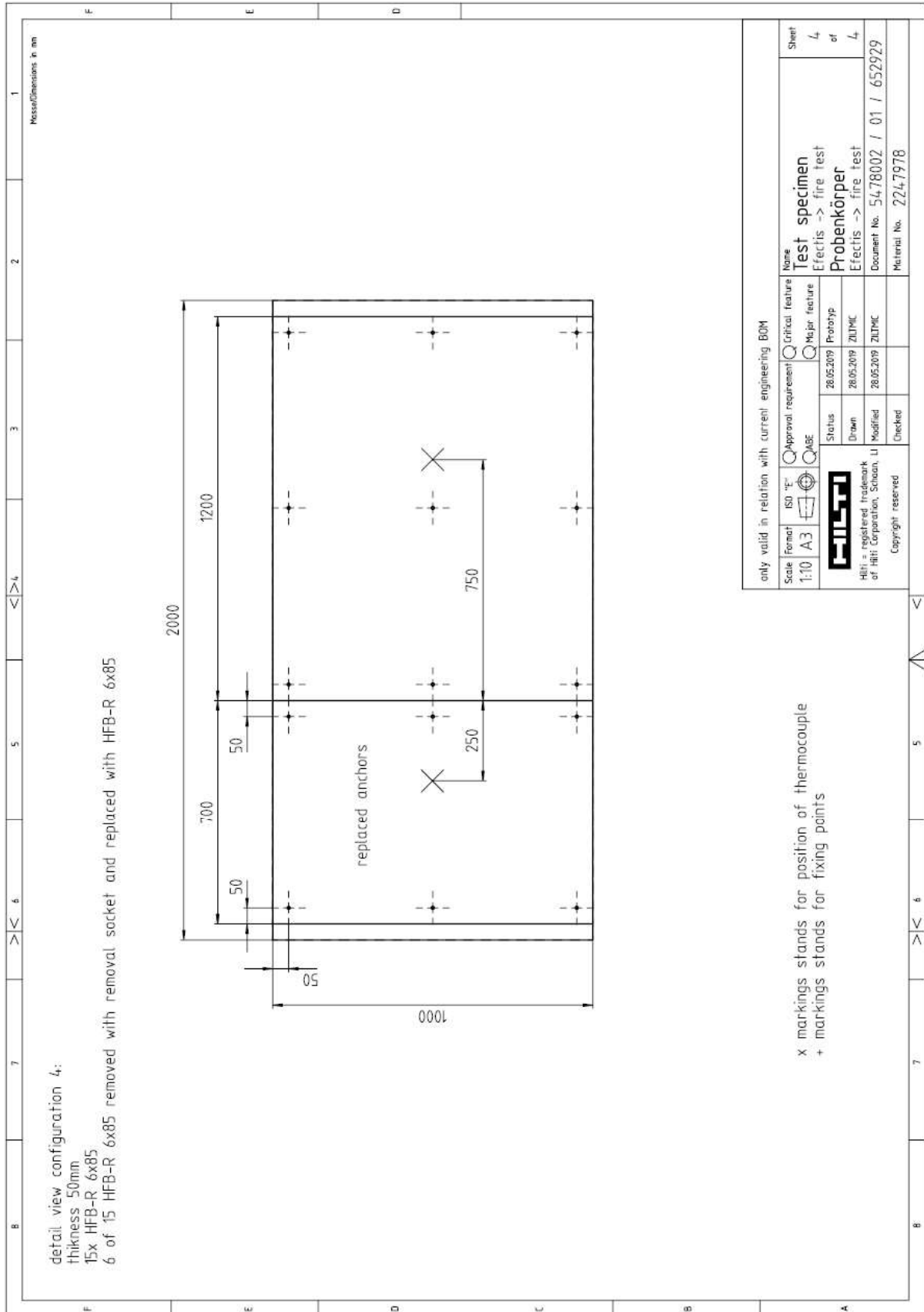

APPENDIX n° 2: LOCATION OF THE THERMOCOUPLES

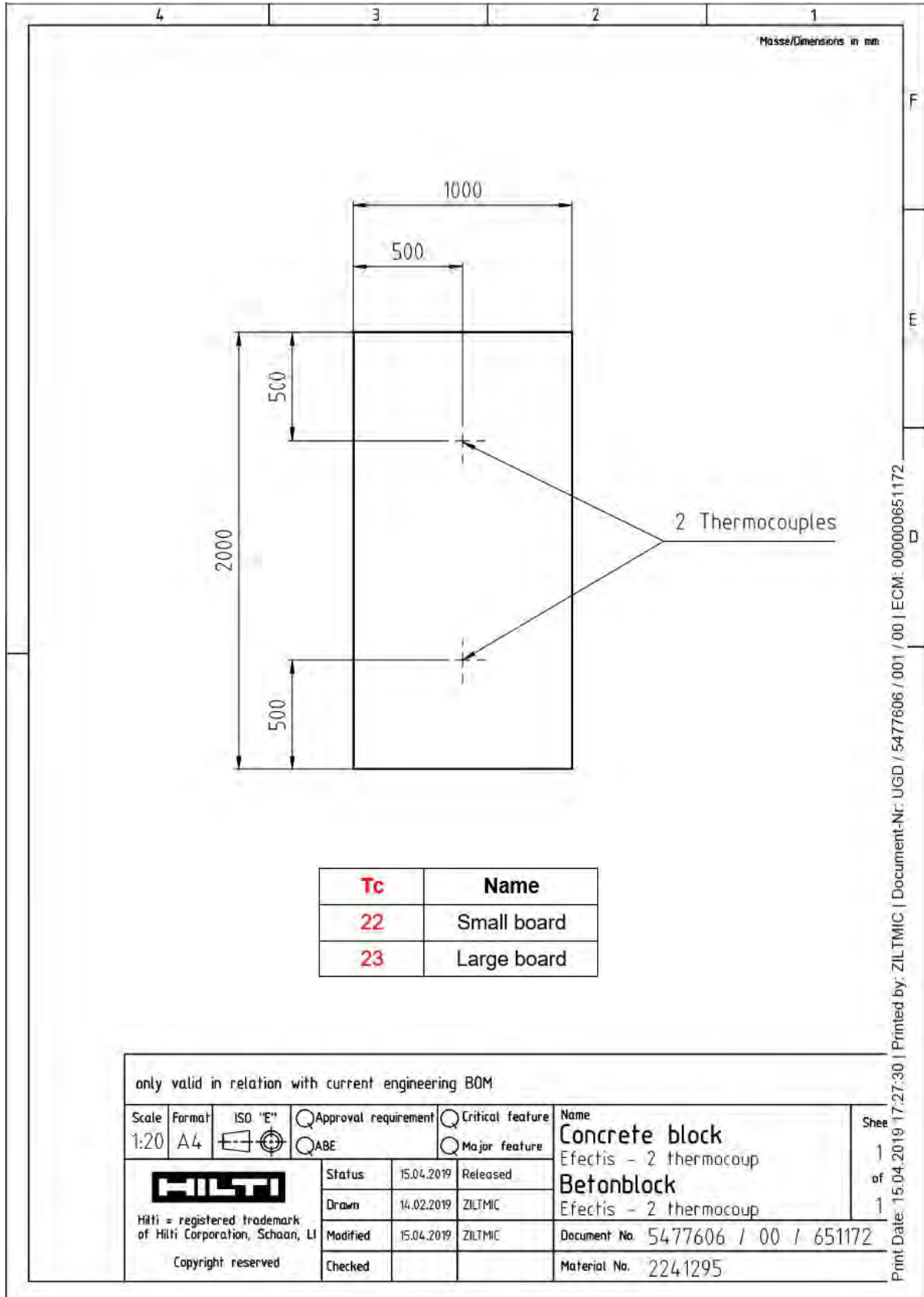

APPENDIX n° 3: CHARTS

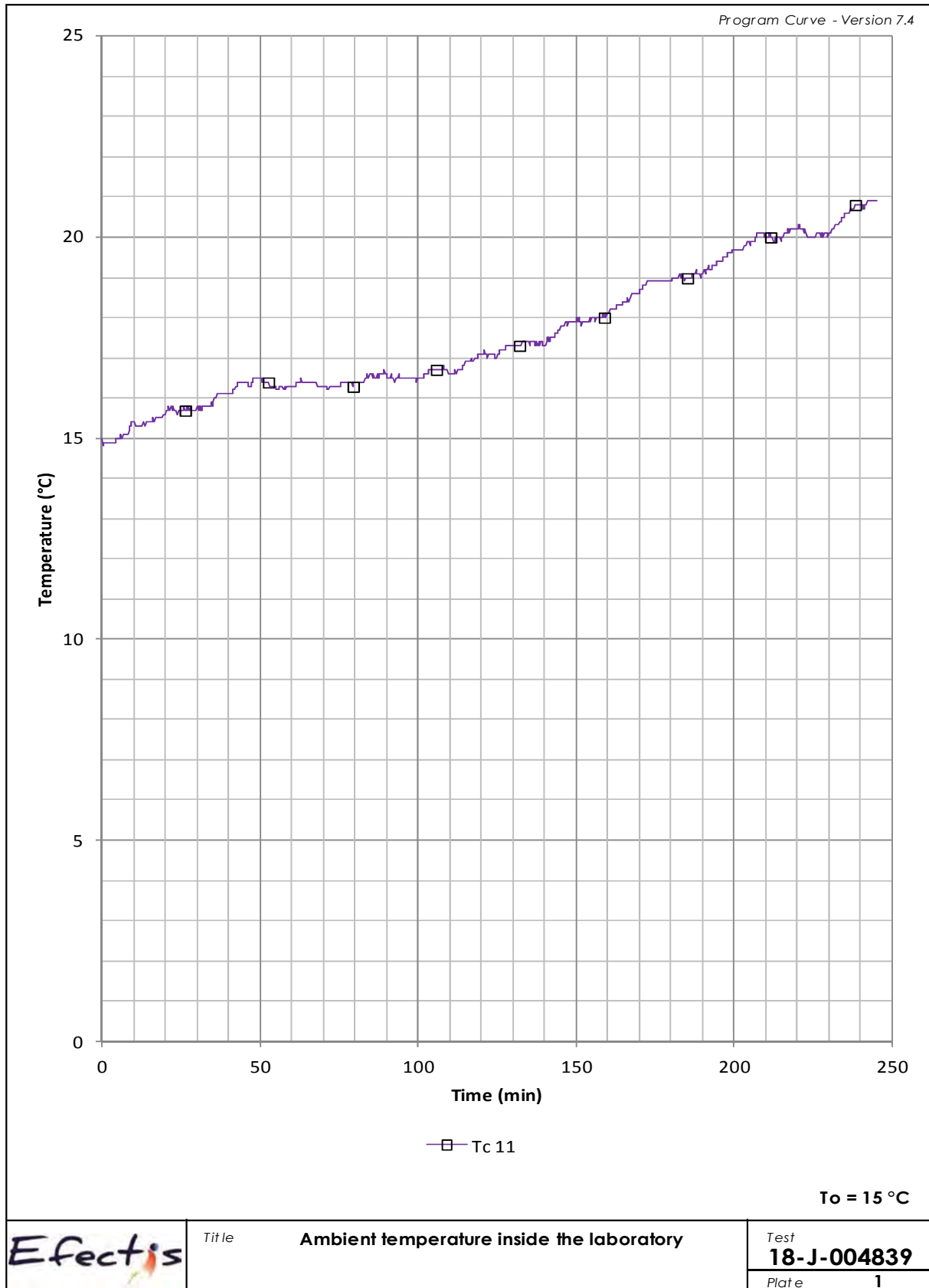

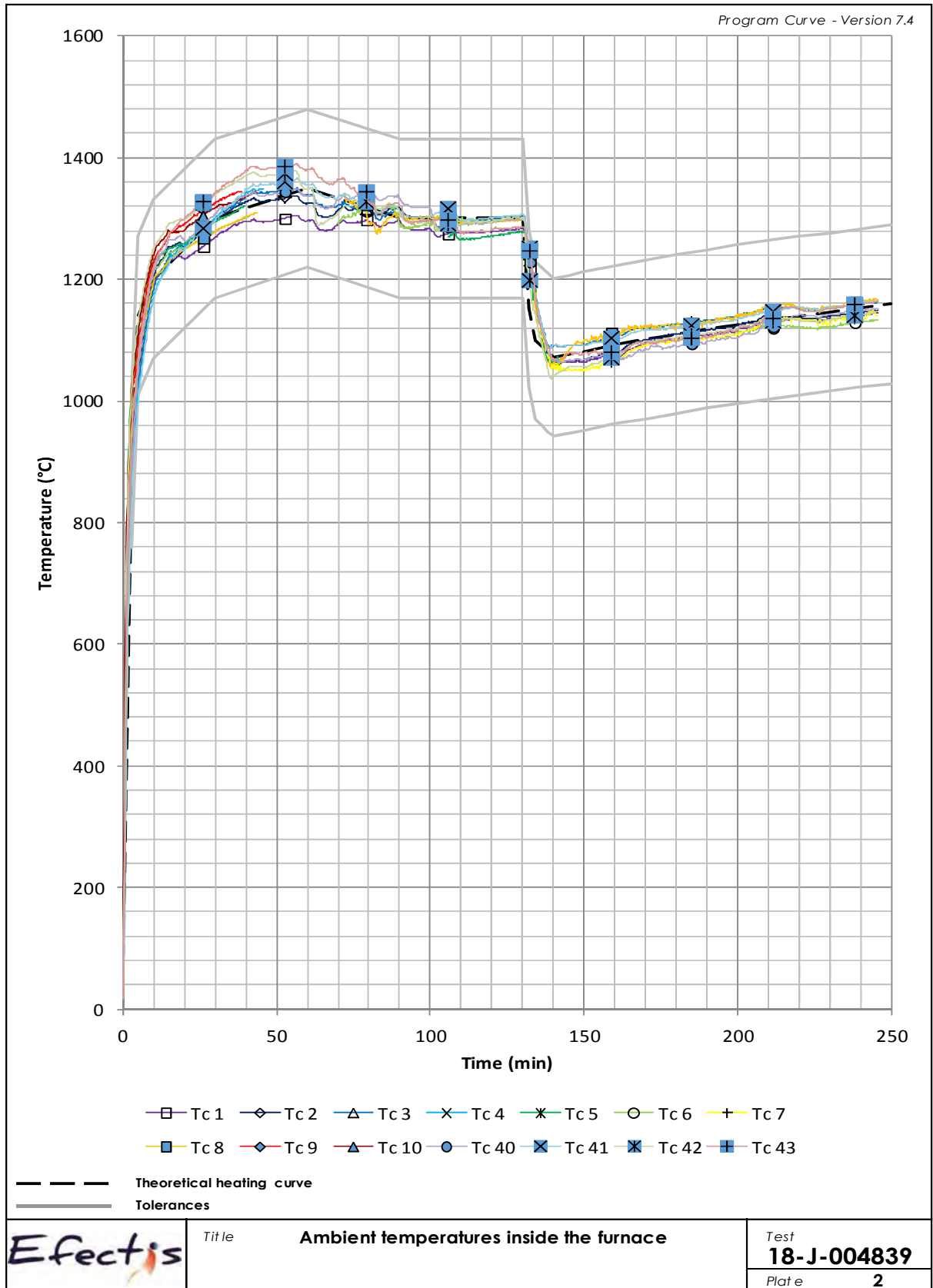

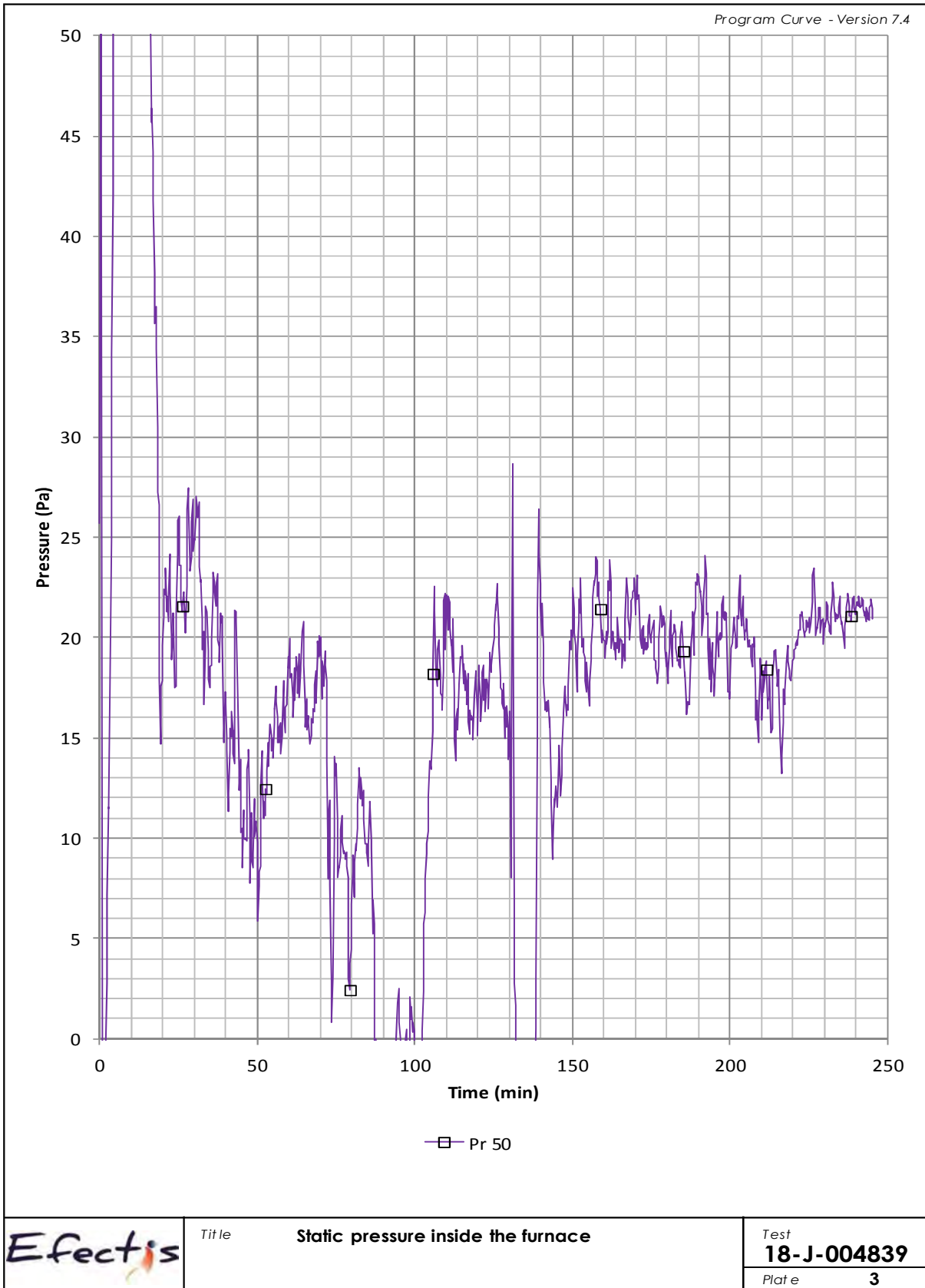

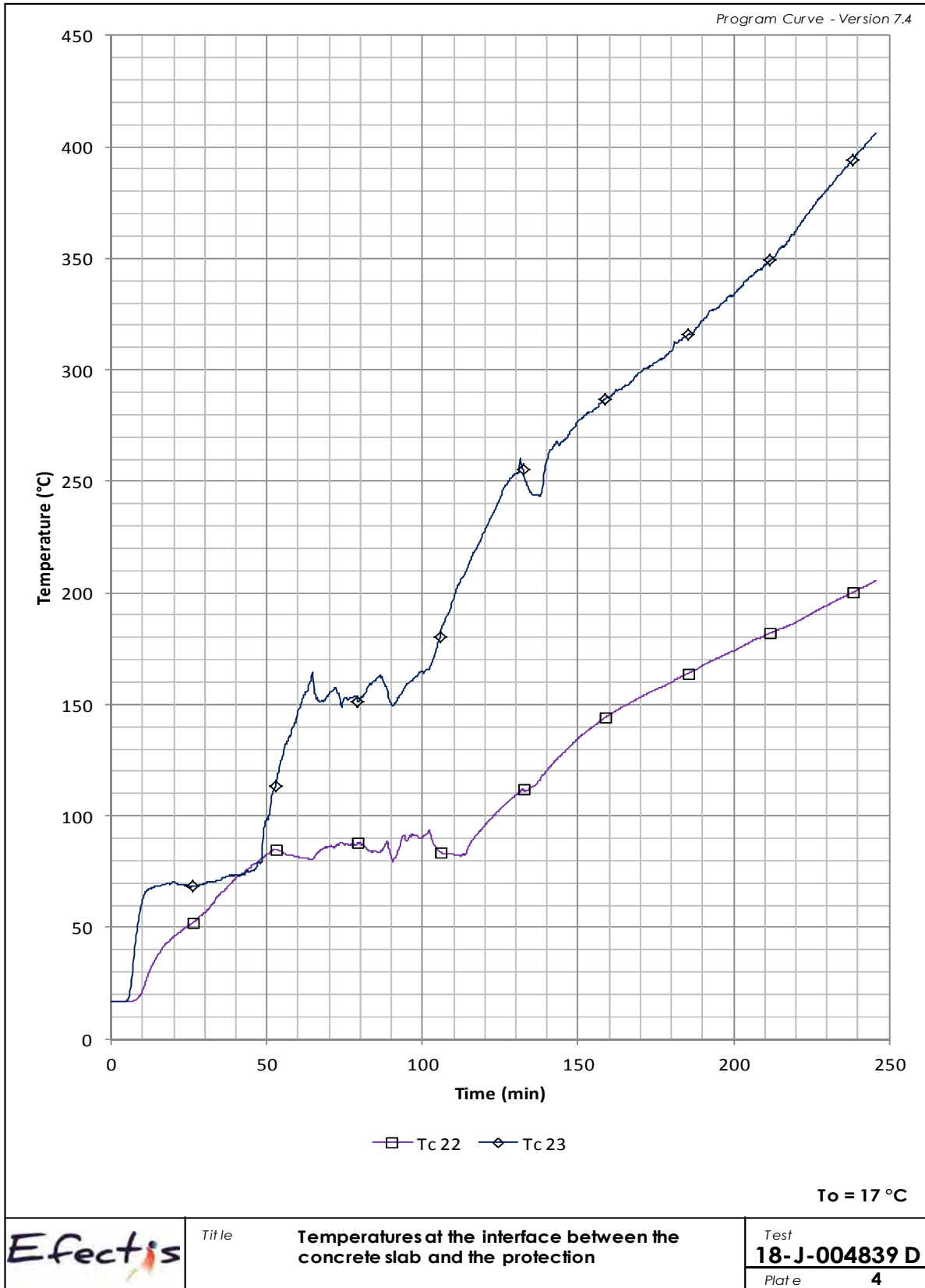

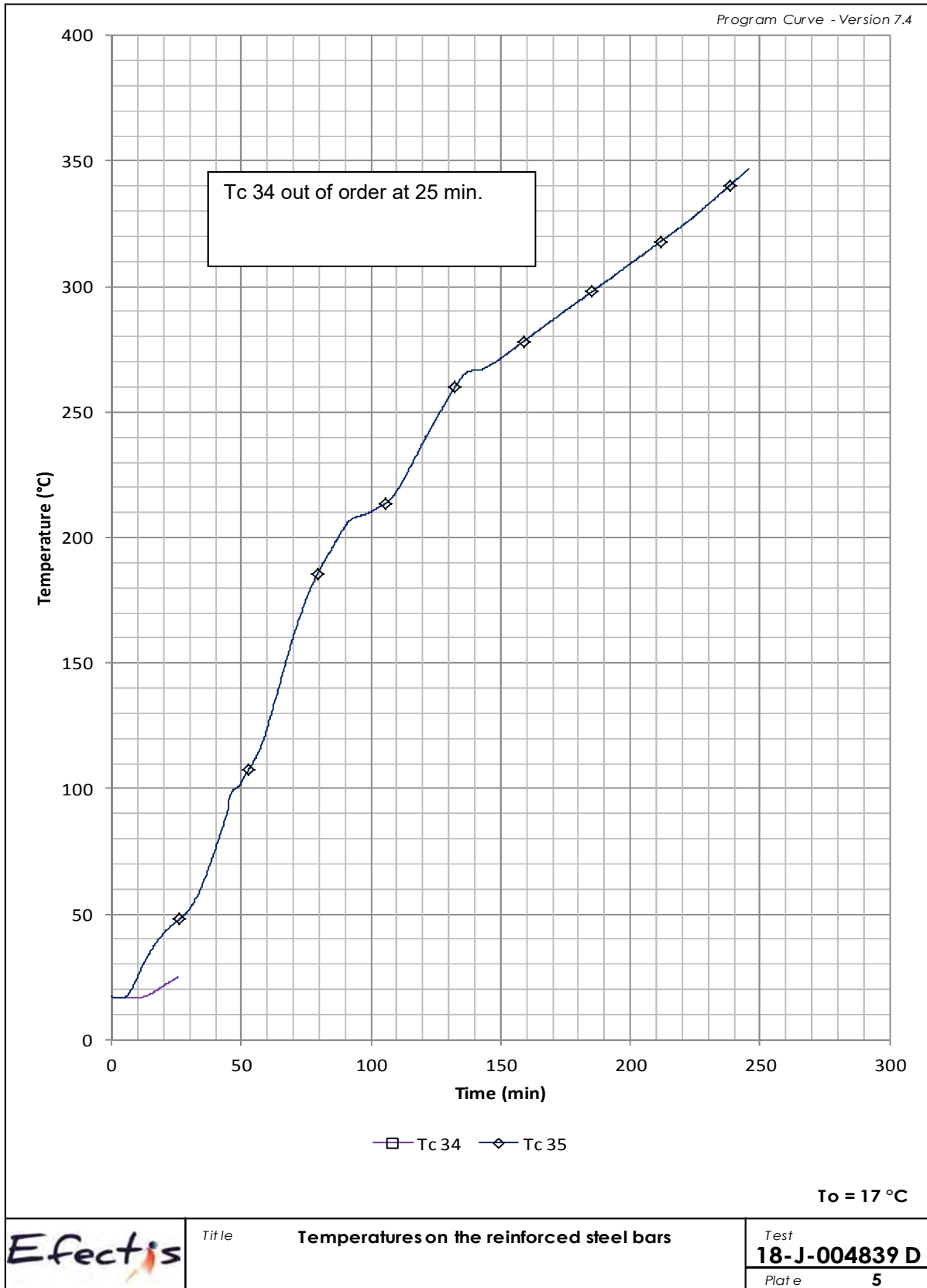



APPENDIX n° 4: PHOTOGRAPHS



<b>Photo A (top)</b>	Installation of the protective boards on the concrete slab.
<b>Photo B (bottom)</b>	Exposed side before the start of the test.



<b>Photo C (top)</b>	Exposed side after the test and cooling down.
<b>Photo D (bottom)</b>	Exposed side after the test and cooling down.

**END OF THE REPORT**